

Features

- Designed in collaboration with Studio McGee
- Diverter spout with slip-fit connection
- 6-3/4" (171 mm) spout reach
- 1-1/4" (31.8 mm) max hole diameter
- Coordinates with other products in the Castia collection

Material

- Premium metal construction for durability and reliability
- KOHLER® finishes resist corrosion and tarnishing

Installation

- Wall-mount

Recommended Products/Accessories

- K-35925 18" towel bar
- K-35926 24" towel bar
- K-35927 Double robe hook
- K-35928 Towel ring
- K-35929 Pivoting toilet paper holder



Codes/Standards





ASME A112.18.1/CSA B125.1
California Energy Commission (CEC)

KOHLER® Faucet Lifetime Limited Warranty

See website for detailed warranty information.

Available Colors/Finishes

Color tiles intended for reference only.

Color	Code	Description
	CP	Polished Chrome
	SN	Vibrant® Polished Nickel
	BN	Vibrant® Brushed Nickel
	BL	Matte Black
	2MB	Vibrant® Brushed Moderne Brass

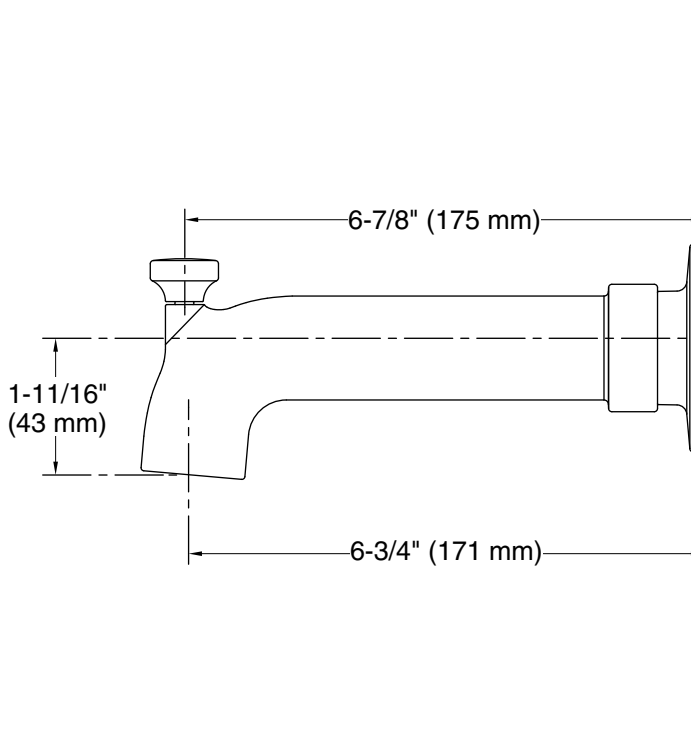
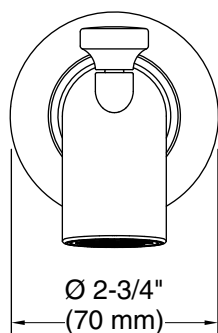

Technical Information

All product dimensions are nominal.

Drain included: No

Notes

Install this product according to the installation instructions.