

Features

- A single handle controls both on/off activation and temperature setting.
- Pressure-balancing diaphragm technology maintains outlet temperature within +/-3°F during water pressure fluctuations.
- Antiscald protection.
- Includes faceplate with ADA-compliant metal level handle.
- Includes 6-9/16" (167 mm) diverter bath spout with slip-fit connection.
- Includes single-function 1.75 gpm (6.6 lpm) showerhead.
- MasterClean™ sprayface features an easy-to-clean surface that withstands mineral buildup.
- Includes shower arm and flange.
- Coordinates with other products in the Tone collection.
- Requires Rite-Temp® pressure-balancing valve (sold separately).

Material

- Premium material construction with metal handle ensures reliability and durability.
- KOHLER finishes resist corrosion and tarnishing.

Water Conservation & Rebates

- This product can help a building earn Water Efficiency points in LEED® Green Building Rating System.

Required Products/Accessories

K-8304 Series Rite-Temp® Valve & Cartridge Kits

or

K-8300 Series Rite-Temp® Valve Body Rough-ins

K-8305 Series Rite-Temp® Cartridges

or

K-2971-KS 3/4" Pressure-balancing Valve

Adapters, Rough-in and Extension Kits

10350 Range: 3-1/2" (89 mm) -
4-1/4" (108 mm)

Recommended Products/Accessories

K-23723 Faucet cleaner

Optional Products/Accessories

K-10350 Deep rough-in kit

K-10351 Test cap for K-8300 Series valve bodies



Codes/Standards

ASME A112.18.1/CSA B125.1

DOE - Energy Policy Act 1992

EPA WaterSense®







California Energy Commission (CEC)

KOHLER® Faucet Lifetime Limited Warranty

See website for detailed warranty information.

Available Colors/Finishes

Color tiles intended for reference only.

Color	Code	Description
	CP	Polished Chrome
	BN	Vibrant® Brushed Nickel
	BL	Matte Black
	2MB	Vibrant® Brushed Moderne Brass
	BMB	Matte Black with Moderne Brass
	CBL	Matte Black with Polished Chrome

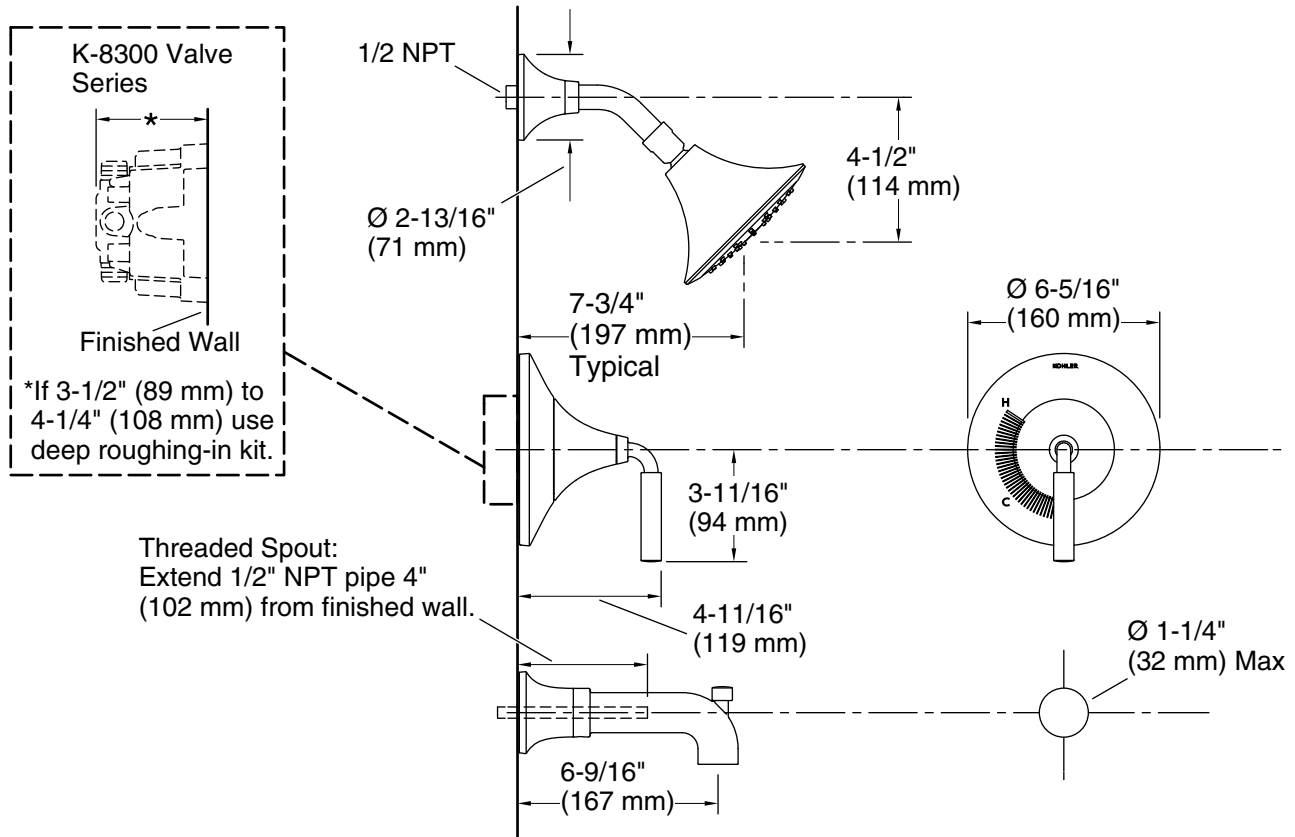

Technical Information

All product dimensions are nominal.

Drain included: No

Spout:

Spout reach: 6-9/16" (166 mm)

Showerhead/Body Spray:

Rated maximum flow: 1.75 gal/min (6.6 l/min)

Pressure: 45 psi (3.1 bar)

Notes

Install this product according to the installation instructions.