



# Underscore® Rectangle

66" x 32" Heated BubbleMassage™ air bath, VibrAcoustic®  
K-1822-GHVB

## Features

- 122 airjets release thousands of heated bubbles that surround, support, and massage the body.
- Variable-speed blower lets you adjust massage intensity to 18 levels.
- Built-in heater.
- Automatic and manual purge cycles remove residual water from air channels after use.
- 60-minute automatic shutoff timer.
- Six concealed speakers send sound waves through the water to gently massage the body.
- Four original instrumental compositions offer different levels of relaxation.
- Fully-adjustable volume above and below the water.
- Customize your experience with the high-resolution color touch screen.
- Six transducers and a control amplifier with 25' (7620 mm) of wiring.
- Slotted overflow allows for deep soaking.
- Generous 66" length provides spacious bathing for up to two people.
- Integral lumbar support.
- Keypad control.
- Textured bottom surface.
- Syncs with devices enabled with BLUETOOTH® wireless technology including smartphones, MP3 players, tablets, and laptops located up to 33 feet away.\*

## Material

- Acrylic.

## Technology

- Heated BubbleMassage™ technology warms and humidifies air before it enters the bath.
- VibrAcoustic calms and soothes with sound vibration technology.
- VibrAcoustic system functions as a stereo system when bath is not in use.

## Installation

- Drop-in or undermount.
- Reversible drain.
- 120V electrical requirement allows for easy installation with standard outlet.
- Requires three dedicated circuits.

## Required Products/Accessories

K-7271 Brass Slotted Overflow Bath Drain

or

K-7272 PVC Slotted Overflow Bath Drain



## Codes/Standards

ASME A112.19.7/CSA B45.10  
CSA B45.5/IAPMO Z124  
ASTM E162  
ASTM E662  
UL 1795  
CSA C22.2 No. 218.2







## KOHLER® Hydrotherapy Components Five-Year Limited Warranty KOHLER® Plastic Baths and Receptors Lifetime Limited Warranty

See website for detailed warranty information.

The BLUETOOTH® word mark and logos are registered trademarks owned by Bluetooth SIG, Inc. and any use of such marks by Kohler Co. is under license. Other trademarks and trade names are those of their respective owners.

## Available Colors/Finishes

*Color tiles intended for reference only.*

Color	Code	Description
	0	White
	96	Biscuit
	NY	Dune
	95	Ice™ Grey
	58	Thunder™ Grey
	7	Black Black™

1-800-4KOHLER (1-800-456-4537)

Kohler Co. reserves the right to make revisions without notice to product specifications.

For the most current Specification Sheet, go to [www.kohler.com](http://www.kohler.com).

2-15-2020 05:08 - US/CA

THE BOLD LOOK  
OF **KOHLER**®



# Underscore® Rectangle

66" x 32" Heated BubbleMassage™ air bath, VibrAcoustic®

K-1822-GHVB

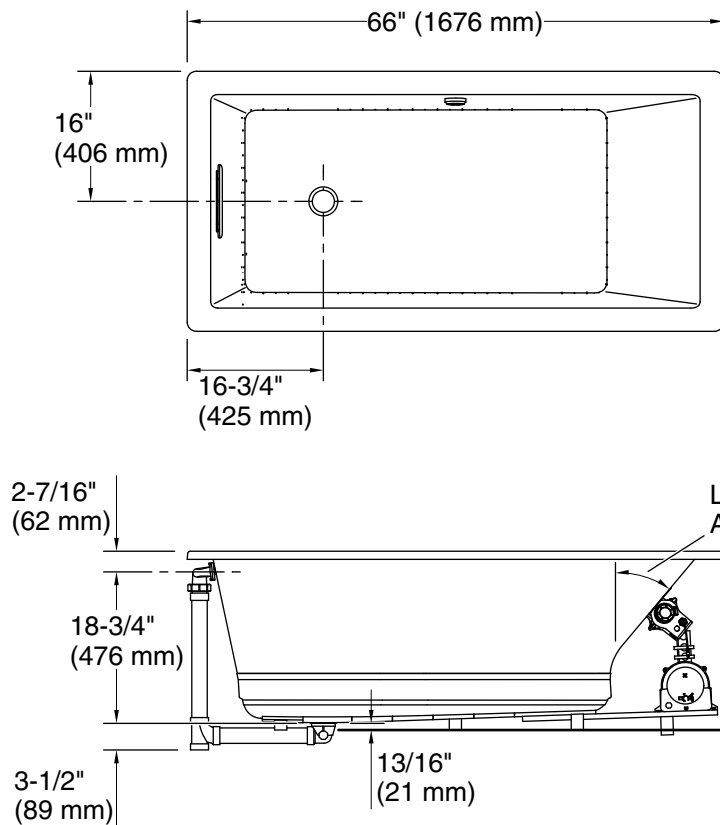

No change in measurements if connected with drain illustrated. (K-7272)

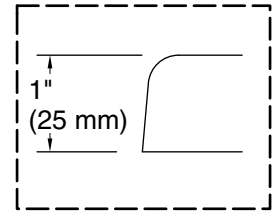

Drop-in Rim Detail

Blower Motor Access  
30" (762 mm) W x 15" (381 mm) H Min

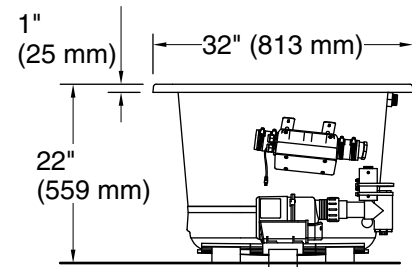

1-1/2" Bath Drain

## Required Electrical Service

Three dedicated circuits required, protected with Class A Ground-Fault Circuit-Interrupter (GFCI). Outside North America, this device may be known as a Residual Current Device (RCD).

Blower:	120 V, 15 A, 60 Hz
Air bath:	120 V, 15 A, 60 Hz
Amplifier:	120 V, 15 A, 60 Hz

## Technical Information

All product dimensions are nominal.

Installation:	Drop-in, Undermount
Drain location:	End
Basin area, bottom:	44-1/2" x 22-5/16" (1130 mm x 567 mm)
Basin area, top:	59-5/8" x 25-1/2" (1514 mm x 648 mm)
Weight:	121 lbs (54.9 kg)
Minimum floor load:	56.7 lbs/ft <sup>2</sup> (276.8 kg/m <sup>2</sup> )
Water depth:	18" (457 mm)
Water capacity:	85.8 gal (324.8 L)
Cutout:	Drop-in, 64-1/2" x 30-1/2" (1638 mm x 775 mm)

## Notes

Measure your actual product for rough-in details. Install this product according to the installation instructions.

The hot water supply should be 70% of the capacity of the bath or greater. Installations will vary.