

Features

- A single handle controls both on/off activation and temperature setting
- 8-11/16" (220 mm) spout reach
- 10.0 gpm (3.8 lpm) maximum bath faucet flow rate at 45 psi (3.1 bar)
- 1.75 gpm (6.6 lpm) maximum handshower flow rate at 80 psi (5.5 bar)
- KOHLER® ceramic disc valves exceed industry longevity standards for a lifetime of durable performance
- Coordinates with other products in the Parallel collection

Material

- Premium metal construction for durability and reliability
- KOHLER® finishes resist corrosion and tarnishing

Installation

- Floor-mount

Required Products/Accessories

K-97339 Mounting block for select floor-mount bath fillers

Recommended Products/Accessories

K-23726 Drain treatment
 K-23723 Faucet cleaner
 K-21897 Double toilet paper holder
 K-23524 18" towel bar
 K-23525 24" towel bar
 K-23526 Towel arm
 K-23527 Vertical toilet paper holder
 K-23528 Pivoting toilet paper holder
 K-23529 Robe hook



Codes/Standards









ASME A112.18.1/CSA B125.1
 DOE - Energy Policy Act 1992
 EPA WaterSense®
 California Energy Commission (CEC)

KOHLER® Faucet Lifetime Limited Warranty

See website for detailed warranty information.

Available Colors/Finishes

Color tiles intended for reference only.

Color	Code	Description
	CP	Polished Chrome
	SN	Vibrant® Polished Nickel
	AF	Vibrant® French Gold
	BN	Vibrant® Brushed Nickel
	BV	Vibrant® Brushed Bronze
	BL	Matte Black
	2MB	Vibrant® Brushed Moderne Brass
	TT	Vibrant Titanium

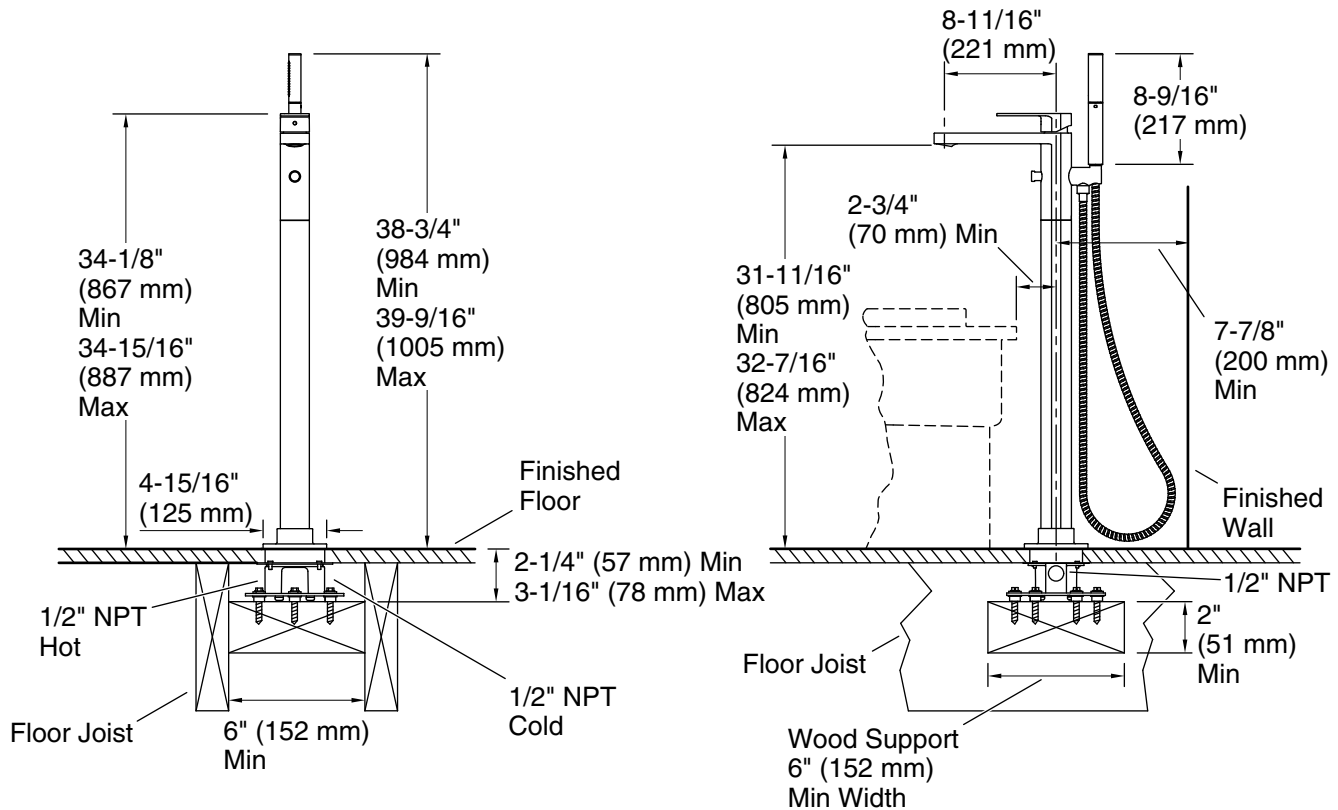

Technical Information

All product dimensions are nominal.

Faucet:

Flow rate: 10 gal/min (37.9 l/min)

Pressure: 45 psi (3.1 bar)

Drain included: No

Spout:

Spout reach: 8-11/16" (220 mm)

Handshower:

Rated maximum flow: 1.75 gal/min (6.6 l/min)

Pressure: 80 psi (5.5 bar)

Notes

Install this product according to the installation instructions.

Adequate floor support is required. The wood support must be a minimum of 2" (51 mm) thick by 6" (152 mm) wide. 2x6 lumber is NOT adequate for this application.

Concrete can be used as the floor support. Requires 3/16" masonry drill bit and six 1/4" x 1-3/4" concrete screws, not included.