

Features

- 30" adjustable slidebar supports a handshower at the desired height for a customized showering experience.

Material

- Durable metal construction.
- KOHLER finishes resist corrosion and tarnishing.



ADA CSA B651

Codes/Standards

ASME A112.18.1/CSA B125.1
ADA
ICC/ANSI A117.1
CSA B651

KOHLER® Faucet Lifetime Limited Warranty

See website for detailed warranty information.

Available Color/Finishes

Color tiles intended for reference only.

Color	Code	Description
	CP	Polished Chrome
	SN	Vibrant® Polished Nickel
	AF	Vibrant® French Gold
	PB	Vibrant® Polished Brass
	BGD	Vibrant® Moderne Brushed Gold
	G	Brushed Chrome
	BN	Vibrant® Brushed Nickel
	BV	Vibrant® Brushed Bronze
	2BZ	Oil-Rubbed Bronze
	BL	Matte Black
	RGD	Vibrant Rose Gold
	TT	Titanium

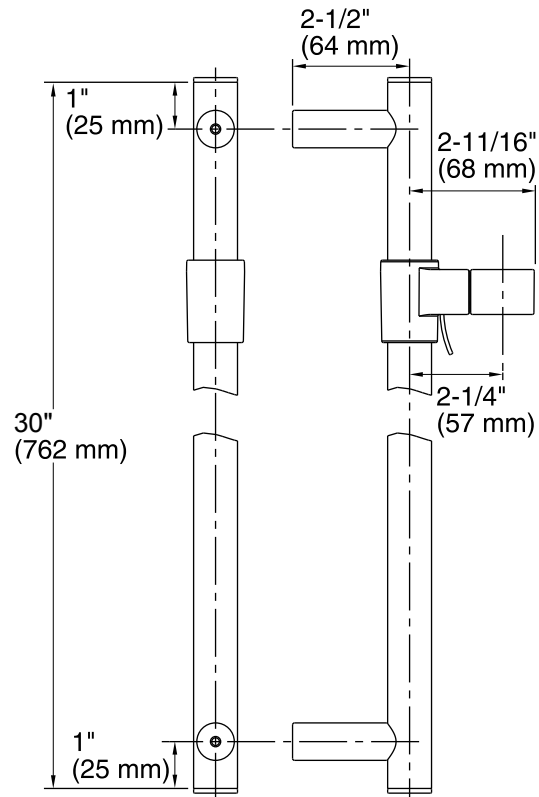

Technical Information

All product dimensions are nominal.

Notes

Install this product according to the installation guide.

ADA, CSA B651 compliant when installed to the specific requirements of these regulations.

Features

- 60-inch hose length.
- Swivel base helps reach target areas.
- For use with a handshower (sold separately).
- KOHLER finishes resist corrosion and tarnishing.

Material

- Durable metal construction.



Codes/Standards













None Applicable

KOHLER® Faucet Lifetime Limited Warranty

See website for detailed warranty information.

Available Color/Finishes

Color tiles intended for reference only.

Color	Code	Description
	CP	Polished Chrome
	SN	Vibrant® Polished Nickel
	AF	Vibrant® French Gold
	PB	Vibrant® Polished Brass
	BGD	Vibrant® Moderne Brushed Gold
	G	Brushed Chrome
	BN	Vibrant® Brushed Nickel
	BV	Vibrant® Brushed Bronze
	2BZ	Oil-Rubbed Bronze
	BL	Matte Black
	RGD	Vibrant Rose Gold
	TT	Titanium
	VNT	Vintage Nickel

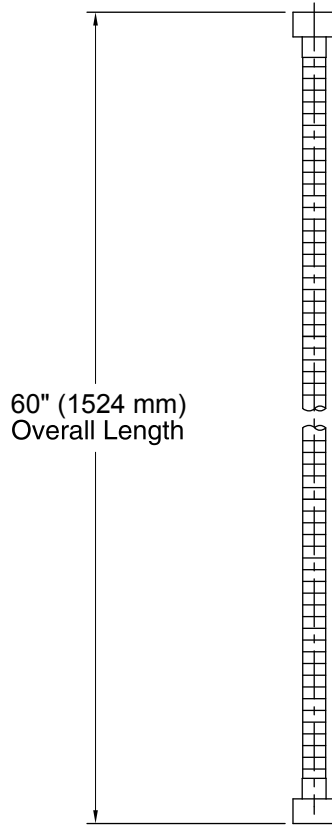

Technical Information

All product dimensions are nominal.

Notes

Install this product according to the installation guide.

Features

- Advanced spray engine provides two spray experiences: full-coverage and targeted massage.
- Full-coverage spray produces an encompassing spray for everyday use and utilizes Katalyst® air induction to create large, full drops.
- Targeted massage spray is a focused stream for targeting sore muscles or use as a utility spray.
- Intuitive and easy push-button activation to switch between two sprays.
- Ergonomic design is comfortable and easy to grip.
- MasterClean™ sprayface resists hard water buildup and is easy to clean.
- 2.5 gpm (gallons per minute) flow rate.
- Contains flow-regulating check valve for backflow prevention.

Material

- KOHLER finishes resist corrosion and tarnishing.

Installation

- Bracket or sidebar required for wall-mount installation.
- Deck-mount holder required for deck-mount installation.

Required Products/Accessories

K-8593 72" Shower Hose

or

K-9514 60" Shower Hose

Optional Products/Accessories

K-9660 Vacuum Breaker



OBC

Codes/Standards

ASME A112.18.1/CSA B125.1

DOE - Energy Policy Act 1992

OBC

KOHLER® Faucet Lifetime Limited Warranty

See website for detailed warranty information.

Available Colors/Finishes

Color tiles intended for reference only.

Color	Code	Description
	CP	Polished Chrome
	SN	Vibrant® Polished Nickel
	BGD	Vibrant® Moderne Brushed Gold
	BN	Vibrant® Brushed Nickel
	BV	Vibrant® Brushed Bronze
	2BZ	Oil-Rubbed Bronze
	BL	Matte Black
	RGD	Vibrant Rose Gold
	TT	Titanium

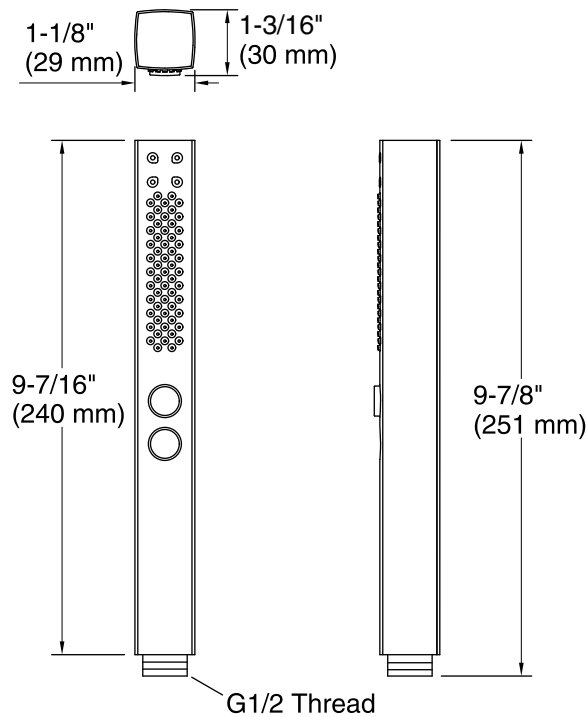

Technical Information

All product dimensions are nominal.

Drain included: No

Handshower:

Rated maximum flow: 2.5 gal/min (9.5 l/min)

Notes

For use with automatic compensating valves rated at 2.2 gal/min (8.3 l/min) or less.

Install this product according to the installation instructions.

Plumbing codes may require that a vacuum breaker be installed in-line to handshowers.

Please consult local plumbing codes.

OBC compliant when installed to the specific requirements of these regulations.

Features

- For use with a handshower and hose (sold separately).
- Includes check valve for backflow prevention.
- Coordinates with Forté faucets and accessories.

Material

- Brass construction.
- KOHLER finishes resist corrosion and tarnishing.

Installation

- Wall-mount.



Codes/Standards







None Applicable

KOHLER® Faucet Lifetime Limited Warranty

See website for detailed warranty information.

Available Colors/Finishes

Color tiles intended for reference only.

Color	Code	Description
	CP	Polished Chrome
	SN	Vibrant® Polished Nickel
	AF	Vibrant® French Gold
	G	Brushed Chrome
	BN	Vibrant® Brushed Nickel
	BV	Vibrant® Brushed Bronze
	2BZ	Oil-Rubbed Bronze

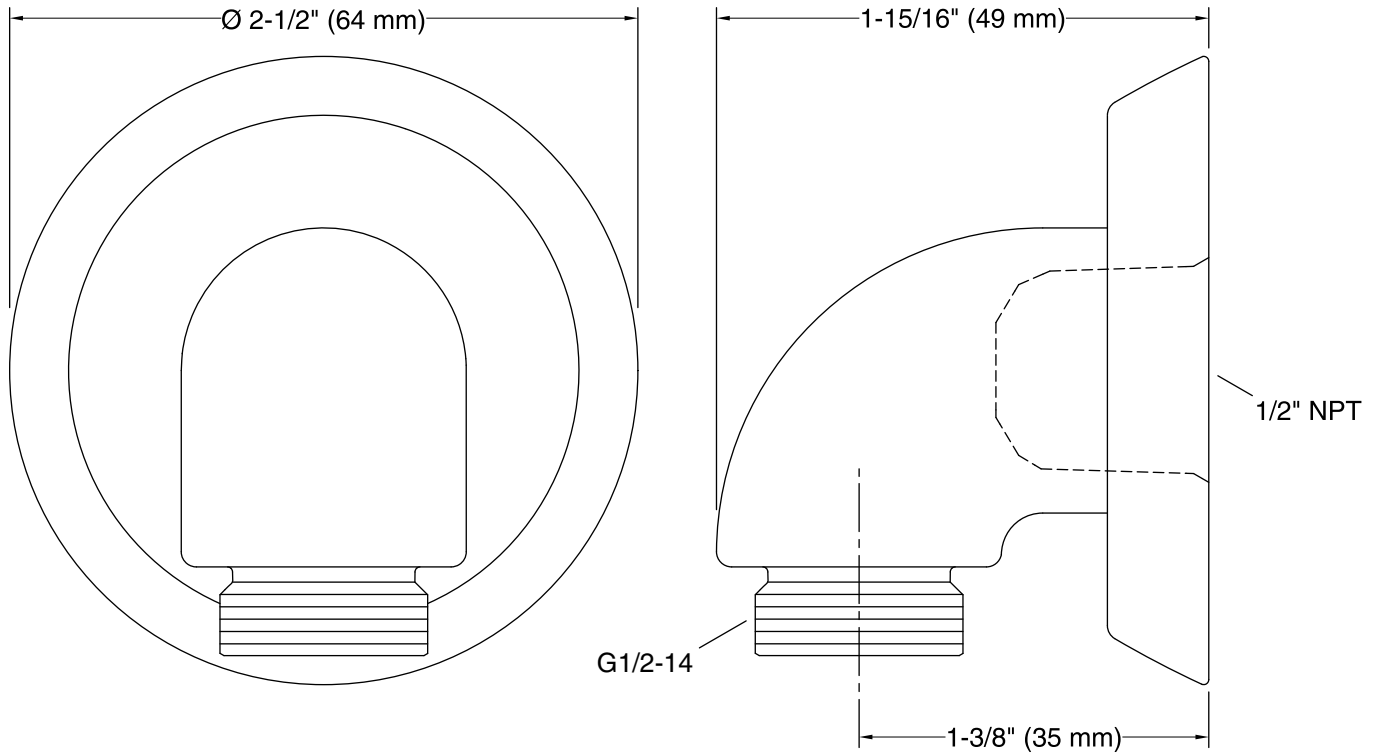

Technical Information

All product dimensions are nominal.

Notes

Install this product according to the installation instructions.

Features

- For use with the K-8524 and K-9069 Slidebars.
- Coordinates with Stillness and Purist faucets and accessories.
- KOHLER finishes resist corrosion and tarnish.

Material

- Durable metal construction.



Codes/Standards

None Applicable

KOHLER® Faucet Lifetime Limited Warranty

See website for detailed warranty information.

Available Color/Finishes

Color tiles intended for reference only.

Color	Code	Description
	CP	Polished Chrome
	SN	Vibrant® Polished Nickel
	AF	Vibrant® French Gold
	BGD	Vibrant® Moderne Brushed Gold
	BN	Vibrant® Brushed Nickel
	BV	Vibrant® Brushed Bronze
	BL	Matte Black
	RGD	Vibrant Rose Gold
	TT	Titanium

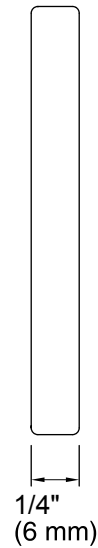
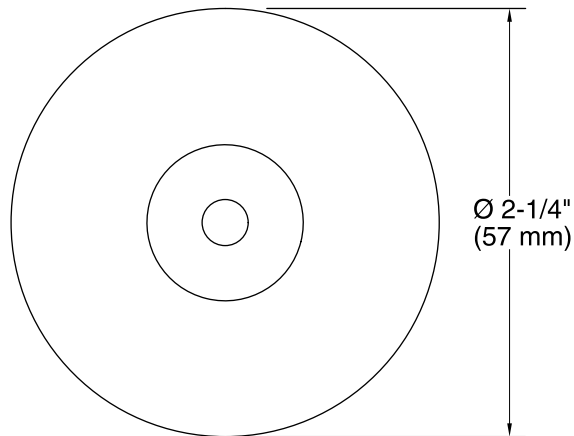

Technical Information

All product dimensions are nominal.

Notes

Install this product according to the installation guide.