

Features

- Advanced spray engine provides three experiences: full coverage, pulsating massage and silk spray.
- Full coverage spray produces an encompassing spray for everyday use and utilizes Katalyst® air induction to create large, full drops.
- Pulsating massage spray targets sore muscles to ease away aches and pains.
- Silk spray releases a dense, luxurious spray ideal for rinsing.
- Thumb tab allows for a smooth transition between sprays.
- Combination of balance, weight, grip, and angle makes this handshower comfortable and easy to use.
- MasterClean™ spray nozzles prohibit mineral buildup for easy cleaning.
- 2.5 gpm (gallons per minute) flow rate.
- Requires K-8593, K-9514, K-98360, K-98359, K-45981, or K-45982 shower hose (sold separately).

Material

- KOHLER finishes resist corrosion and tarnishing.

Installation

- Coordinates with Purist®, Stillness®, and Composed® faucets and accessories.
- Bracket or sidebar required for wall-mount installation.
- Deck-mount holder required for deck-mount installation.

Required Products/Accessories

K-9514 60" Shower Hose

or

K-98359 60" Smooth Shower Hose

or

K-45982 60" ribbon hose

or

K-8593 72" Shower Hose

or

K-98360 72" Smooth Shower Hose

or

K-45981 72" ribbon hose



ADA

CSA B651

OBC

Codes/Standards

ASME A112.18.1/CSA B125.1

DOE - Energy Policy Act 1992

ADA

ICC/ANSI A117.1

CSA B651





OBC

KOHLER® Faucet Lifetime Limited Warranty

See website for detailed warranty information.

Available Colors/Finishes

Color tiles intended for reference only.

Color	Code	Description
	CP	Polished Chrome
	SN	Vibrant® Polished Nickel
	BN	Vibrant® Brushed Nickel
	BV	Vibrant® Brushed Bronze
	BL	Matte Black
	TT	Titanium

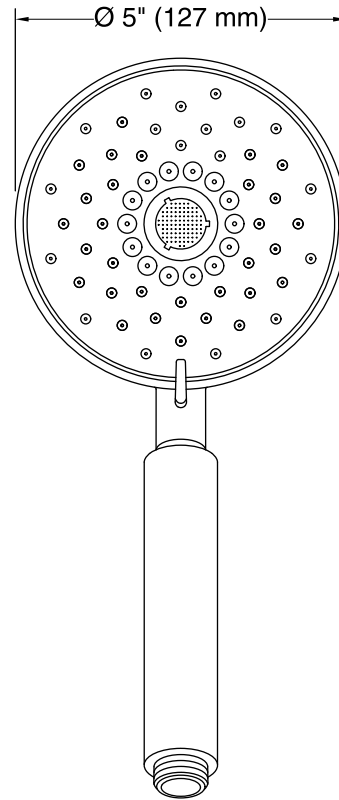
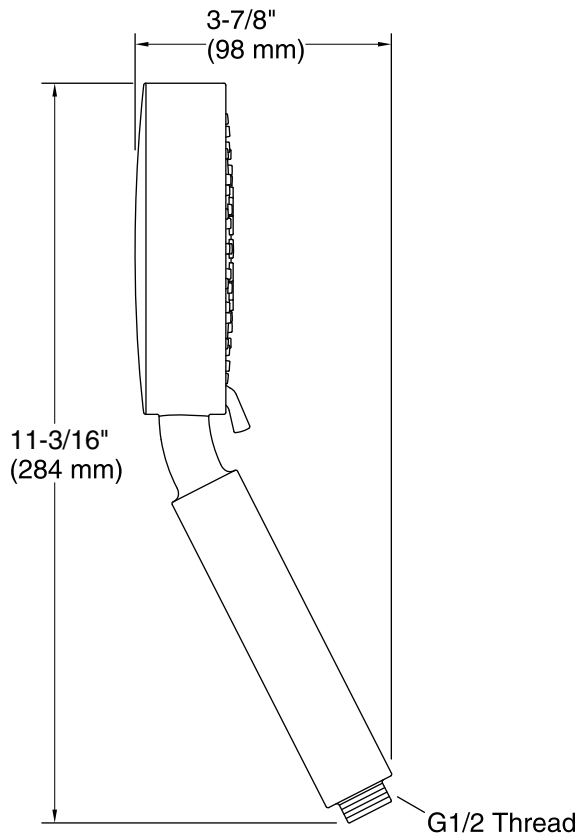

Technical Information

All product dimensions are nominal.

Handshower:

Rated maximum flow: 2.5 gal/min (9.5 l/min)

Notes

Install this product according to the installation instructions.

Plumbing codes require an atmospheric vacuum breaker (such as Kohler Model K-9660) be installed in-line with handshowers. Please consult with local plumbing officials.

ADA, OBC, CSA B651 compliant when installed to the specific requirements of these regulations.

Features

- For use with a handshower and hose (sold separately).
- Includes check valve for backflow prevention.
- Coordinates with Purist and Stillness faucets and accessories.

Material

- Brass construction.
- KOHLER finishes resist corrosion and tarnishing.

Installation

- Wall-mount.



Codes/Standards

None Applicable

KOHLER® Faucet Lifetime Limited Warranty

See website for detailed warranty information.

Available Colors/Finishes

Color tiles intended for reference only.

Color	Code	Description
	CP	Polished Chrome
	SN	Vibrant® Polished Nickel
	BGD	Vibrant® Moderne Brushed Gold
	BN	Vibrant® Brushed Nickel
	BV	Vibrant® Brushed Bronze
	RGD	Vibrant Rose Gold
	TT	Titanium

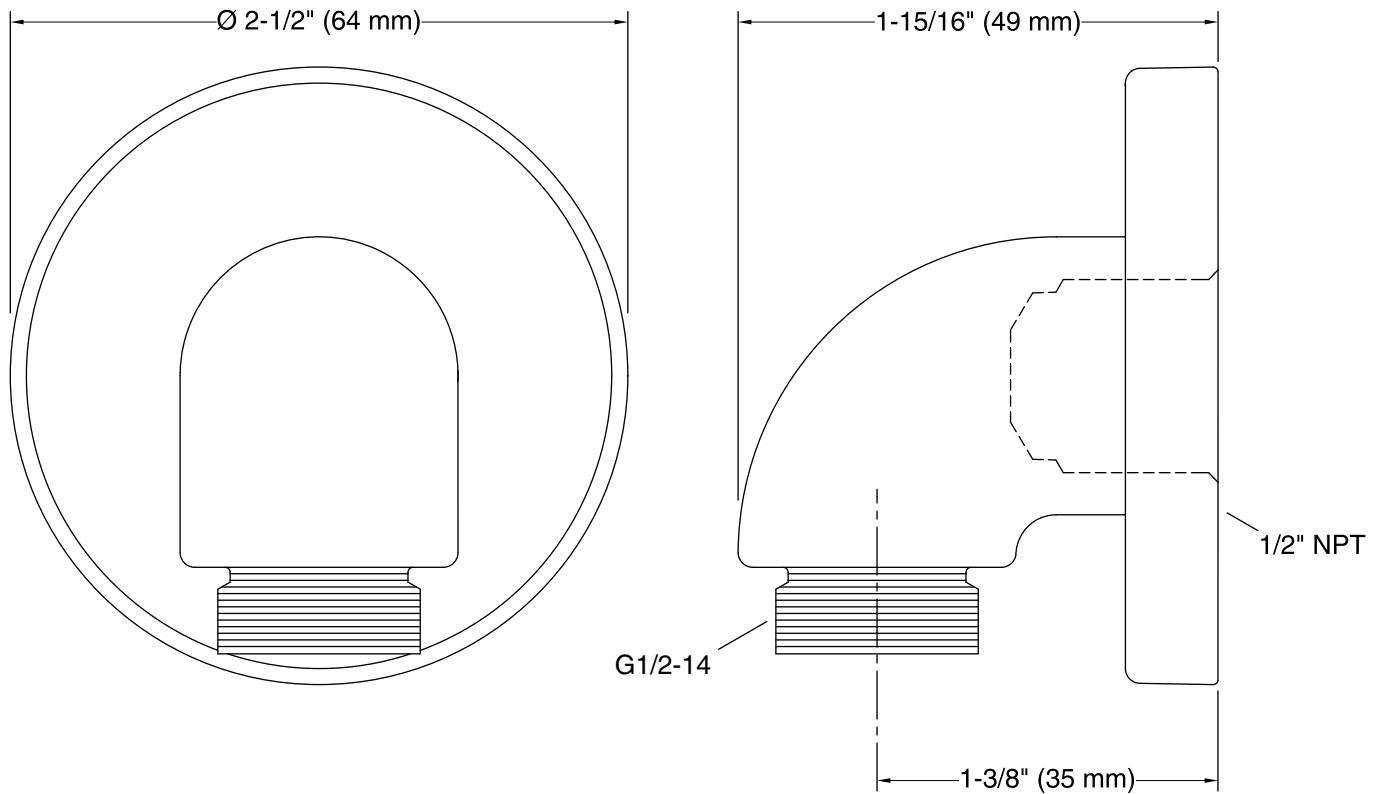

Technical Information

All product dimensions are nominal.

Notes

Install this product according to the installation instructions.

Features

- Transfers water flow to up to three separate components/outlets.
- Components/outlets can be operated individually or in any combination of two components at the same time.
- Supplied as a three-way transfer valve (360 degree handle rotation) but can be configured onsite for two-way operation (120 degree handle rotation).
- Single handle operation.
- Using 1 outlet: 18 gpm flow rate at 45 psi; using 2 outlets: 20.8 gpm at 45 psi.
- One 3/4" female NPT inlet connection.
- Three 1/2" female NPT outlet connections.
- Requires additional valve/s to control On/Off operation and temperature (sold separately).
- Requires transfer/diverter valve trim (sold separately).

Material

- Forged dezincification-resistant brass body provides long term reliability and resistance to aggressive water conditions.



Codes/Standards

ASME A112.18.1/CSA B125.1

KOHLER® Faucet Lifetime Limited Warranty

See website for detailed warranty information.

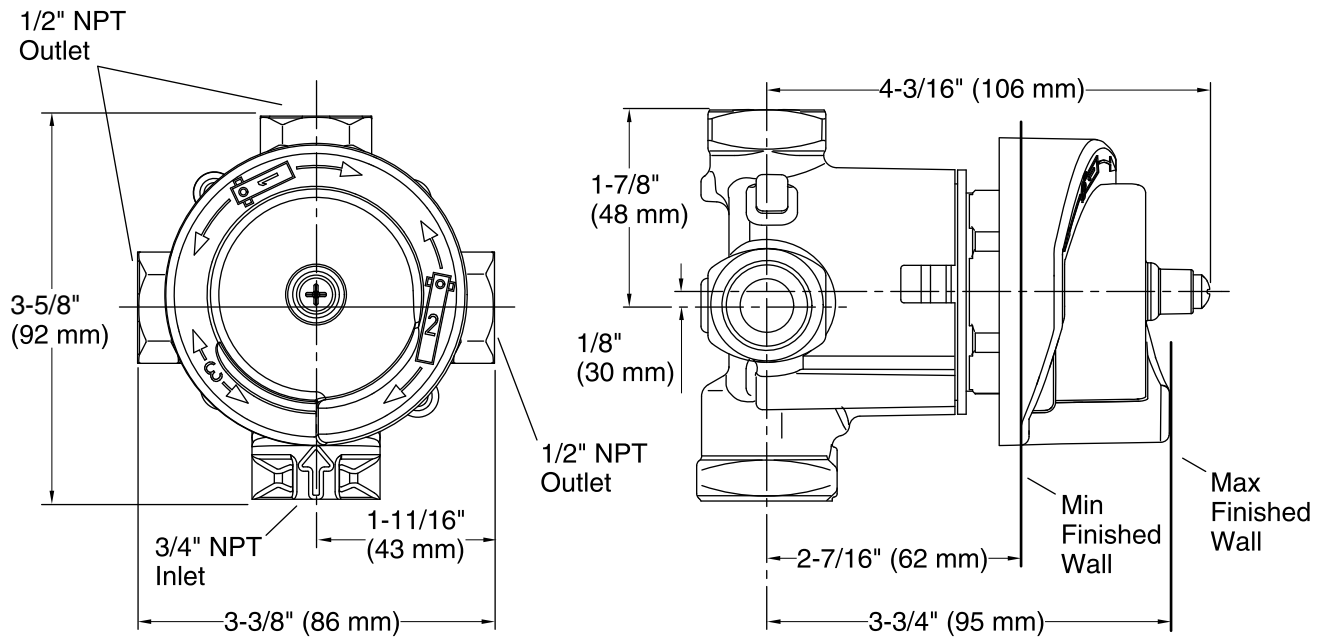

Technical Information

All product dimensions are nominal.

Features

- Includes valve body, pressure balance cartridge, rough-in guide and mud guard
- 1/2" Universal NPT & direct sweat inlets & outlets, with stops
- Service stops include integral check valves
- 5.0 gpm (18.9 l/min) maximum flow rate at 45 psi
- Single lever design cycles from off through cold to hot
- Provides temperature regulation and automatic anti-scald protection
- One piece cartridge design simplifies installation and maintenance
- Adjustable high temperature limit stop to control maximum water temperature
- Requires valve trim to complete installation (sold separately).

Material

- Forged De-zincification Resistant Brass body provides long term reliability and resistance to aggressive water conditions

Technology

- Pressure-balancing diaphragm technology maintains outlet temperature within +/- 3 degrees Fahrenheit during water pressure fluctuations

Installation

- Designed for use in standard, back to back and thin wall installations
- Valve body features integral mounting locations and symmetrical valve inlets to simplify installation
- Cartridge is reversible for installations where hot and cold supplies are reversed.
- Rough-in guide designed for both standard and thin wall installations
- Installed valve rough-in can be flushed and pressure tested to 150psi max (air or water) without cartridge, using K-10351 Test Cap

Optional Accessories

- K-10350 Deep Rough-In Kit For K-8305 Cartridges
- K-10351 Test Cap For K-8300 Series Valve Bodies



Codes/Standards

ASME A112.18.1/CSA B125.1
ASSE 1016

KOHLER® Faucet Lifetime Limited Warranty

See website for detailed warranty information.

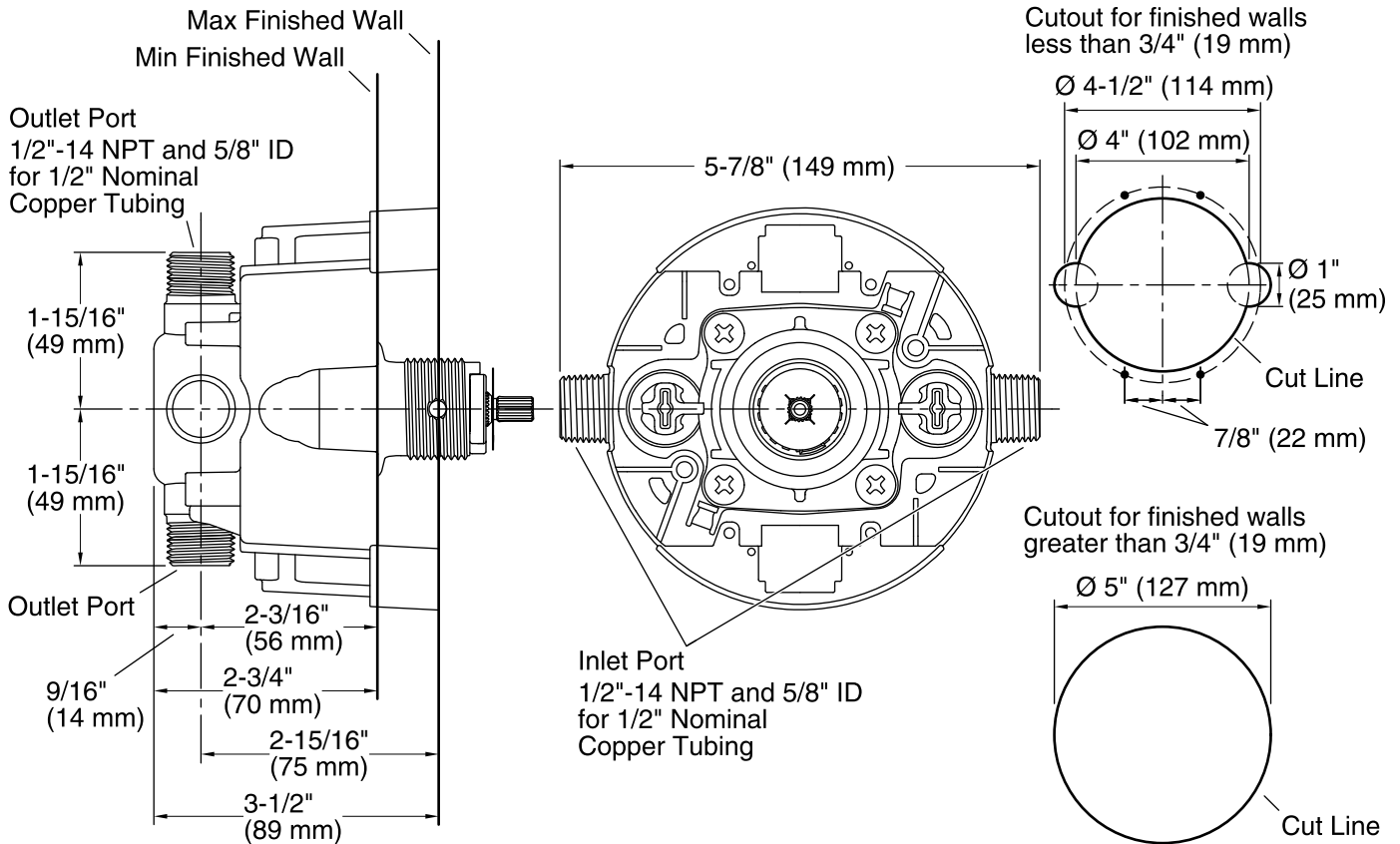

Technical Information

All product dimensions are nominal.

Valve body: Machined Brass

Shower Valve:

Min. pressure IN: 20 psi (1.4 bar)

Notes

Install this product according to the installation guide.

Avoid cross-flow conditions. Do not install shut-off device on either valve outlet.

Cap the shower outlet if deck-mount spout, diverter, or handshower is connected to the spout outlet.

Install straight pipe or tube drop of 7" (178 mm) to 18" (457 mm) with single elbow between the valve and wall-mount spout.

For finished walls greater than 3/4" (19 mm) and less than 1-1/2" (38 mm), install support(s) 2" (51 mm) from the stud face.

For finished walls greater than 1-1/2" (38 mm), install support(s) 3" (76 mm) from the face of the finished wall.

Features

- 30" adjustable slidebar supports a handshower at the desired height for a customized showering experience.

Material

- Durable metal construction.
- KOHLER finishes resist corrosion and tarnishing.



ADA

CSA B651

OBC

Codes/Standards

ASME A112.18.1/CSA B125.1

ADA

ICC/ANSI A117.1











CSA B651

OBC

See website for detailed warranty information.

Available Color/Finishes

Color tiles intended for reference only.

Color	Code	Description
	CP	Polished Chrome
	SN	Vibrant® Polished Nickel
	AF	Vibrant® French Gold
	PB	Vibrant® Polished Brass
	BGD	Vibrant® Moderne Brushed Gold
	G	Brushed Chrome
	BN	Vibrant® Brushed Nickel
	BV	Vibrant® Brushed Bronze
	2BZ	Oil-Rubbed Bronze
	TT	Vibrant Titanium

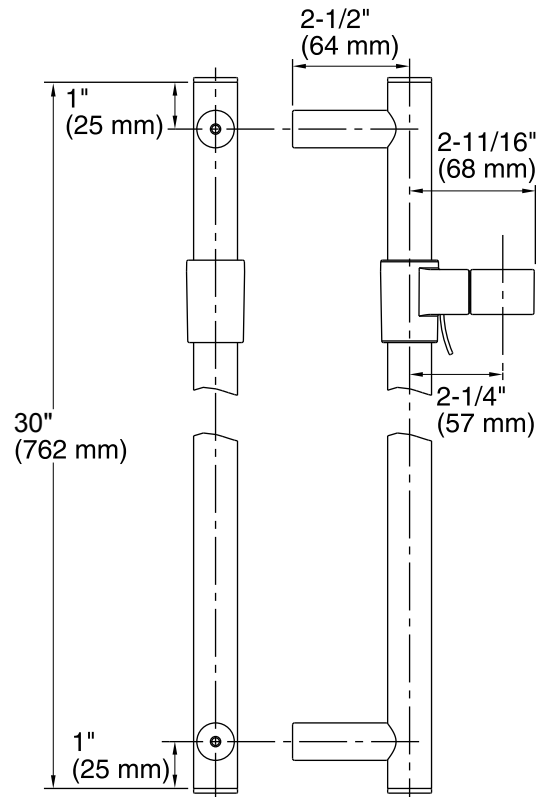

Technical Information

All product dimensions are nominal.

Notes

Install this product according to the installation guide.

ADA, OBC, CSA B651 compliant when installed to the specific requirements of these regulations.

Features

- 1/2" - 14 NPT connection.
- Fluid design lines for ease of cleaning.
- For use with KOHLER showerheads (sold separately).

Material

- Metal construction.



Codes/Standards

ASME A112.18.1/CSA B125.1

KOHLER® Faucet Lifetime Limited Warranty

See website for detailed warranty information.

Available Color/Finishes

Color tiles intended for reference only.

Color	Code	Description
	CP	Polished Chrome
	SN	Vibrant® Polished Nickel
	BN	Vibrant® Brushed Nickel
	BV	Vibrant® Brushed Bronze
	BL	Matte Black
	RGD	Vibrant Rose Gold

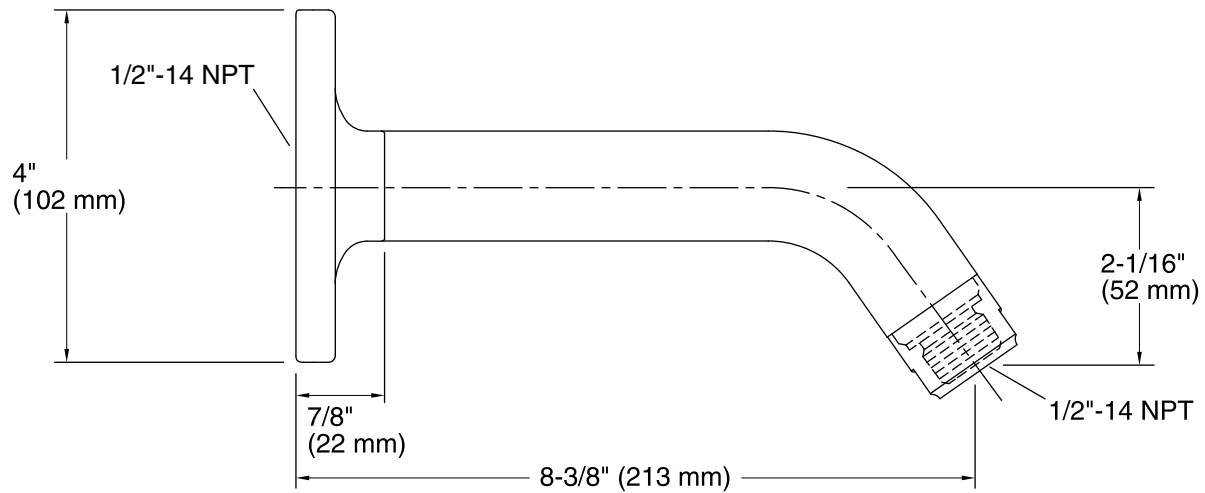

Technical Information

All product dimensions are nominal.

Notes

Install this product according to the installation guide.

Features

- Katalyst® air-induction technology maximizes the air/water mix for a powerful, even flow.
- MasterClean™ sprayface resists hard water build-up and is easy to clean.
- Single-function showerhead with 48 translucent nozzles.
- 5-1/2" (140 mm) diameter sprayface.
- 1.75 gpm (6.6 lpm) flow rate.
- Complements the Purist® collection.

Material

- KOHLER finishes resist corrosion and tarnishing.

Installation

- Wall-mount.
- Shower arm and flange not included.

Recommended Products/Accessories

K-7397 Shower Arm and Flange



Codes/Standards

ASME A112.18.1/CSA B125.1

DOE - Energy Policy Act 1992

EPA WaterSense®

California Energy Commission (CEC)

KOHLER® Faucet Lifetime Limited Warranty

See website for detailed warranty information.

Available Colors/Finishes

Color tiles intended for reference only.

Color	Code	Description
	CP	Polished Chrome
	SN	Vibrant® Polished Nickel
	BGD	Vibrant® Moderne Brushed Gold
	BN	Vibrant® Brushed Nickel
	BV	Vibrant® Brushed Bronze
	BL	Matte Black
	RGD	Vibrant Rose Gold
	TT	Titanium

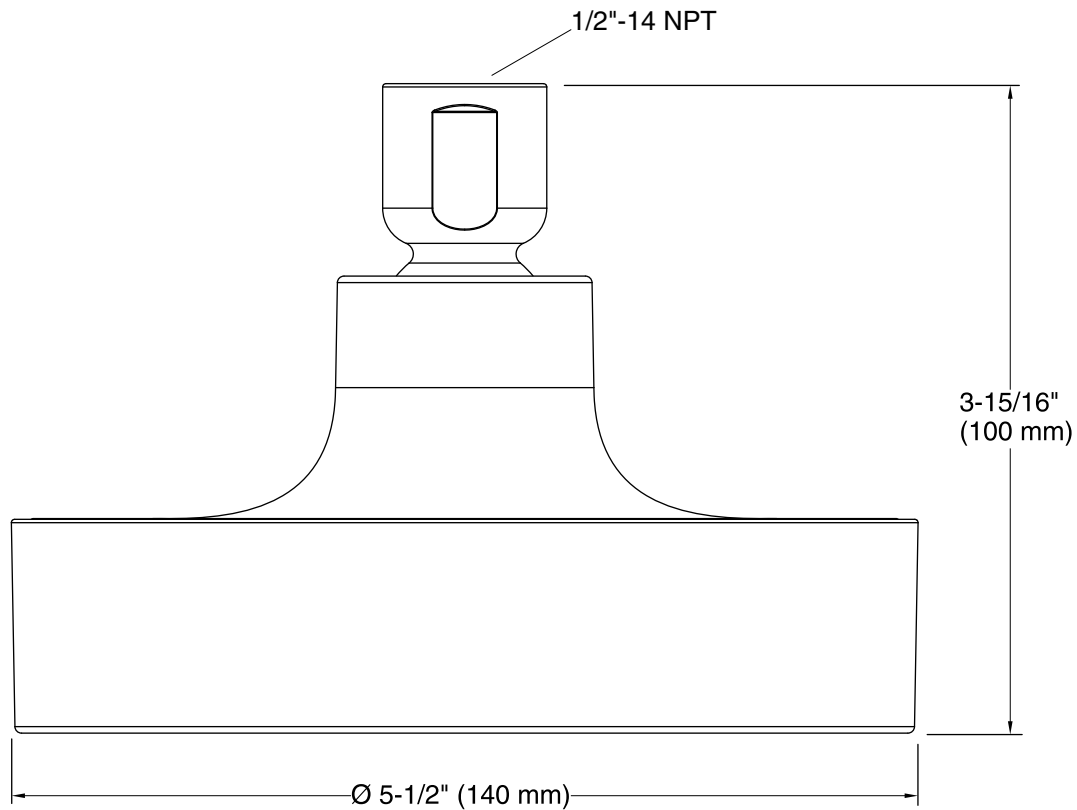

Technical Information

All product dimensions are nominal.

Showerhead/Body Spray:

Rated maximum flow: 1.75 gal/min (6.6 l/min)

Pressure: 80 psi (5.5 bar)

Notes

For use with automatic compensating valves rated at 1.5 gal/min (5.7 l/min) or less.

Install this product according to the installation instructions.

Features

- 60-inch hose length.
- Swivel base helps reach target areas.
- For use with a handshower (sold separately).
- KOHLER finishes resist corrosion and tarnishing.

Material

- Durable metal construction.



Codes/Standards











None Applicable

KOHLER® Faucet Lifetime Limited Warranty

See website for detailed warranty information.

Available Color/Finishes

Color tiles intended for reference only.

Color	Code	Description
	CP	Polished Chrome
	SN	Vibrant® Polished Nickel
	AF	Vibrant® French Gold
	PB	Vibrant® Polished Brass
	BGD	Vibrant® Moderne Brushed Gold
	G	Brushed Chrome
	BN	Vibrant® Brushed Nickel
	BV	Vibrant® Brushed Bronze
	2BZ	Oil-Rubbed Bronze
	RGD	Titanium
	TT	Vintage Nickel
	VNT	

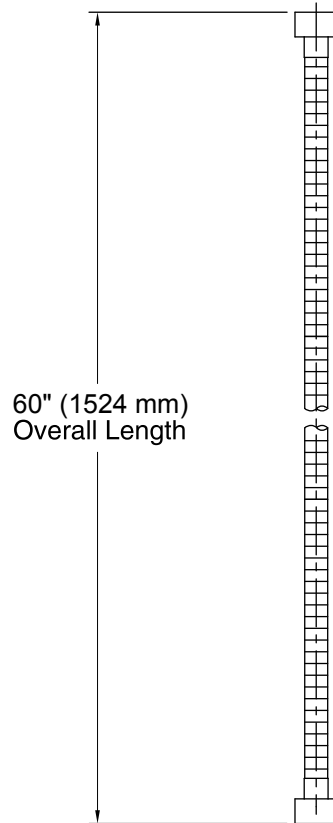

Technical Information

All product dimensions are nominal.

Notes

Install this product according to the installation guide.

Features

- For use with the K-8524 and K-9069 slidebars.
- Coordinates with Stillness and Purist faucets and accessories.
- KOHLER finishes resist corrosion and tarnish.

Material

- Durable metal construction.



Codes/Standards





None Applicable

KOHLER® Faucet Lifetime Limited Warranty

See website for detailed warranty information.

Available Color/Finishes

Color tiles intended for reference only.

Color	Code	Description
	CP	Polished Chrome
	SN	Vibrant® Polished Nickel
	BGD	Vibrant® Moderne Brushed Gold
	BN	Vibrant® Brushed Nickel
	BV	Vibrant® Brushed Bronze
	TT	Vibrant Titanium

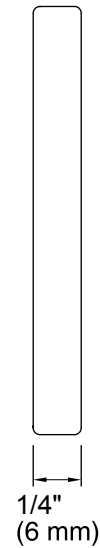
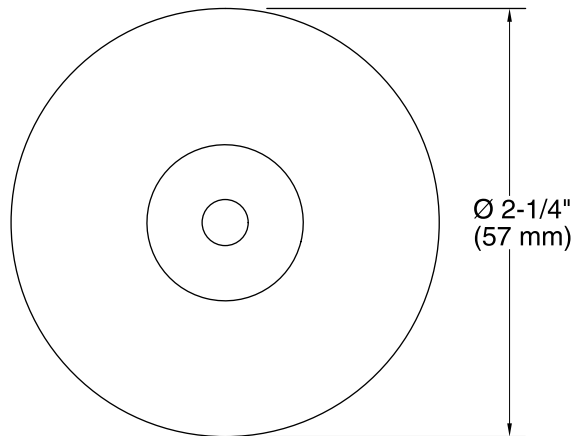

Technical Information

All product dimensions are nominal.

Notes

Install this product according to the installation guide.

Features

- Includes face plate with handle.
- Single handle controls flow to outlets.
- Supplied with ADA compliant metal cross handle.
- When used with K-728 Series MasterShower diverter valves, handle controls flow to two or three outlets individually or any two outlets at a time.
- When used with K-737 Series MasterShower diverter valves, handle controls flow to two or three outlets individually (only one outlet at a time).
- Valve (not supplied) can be configured on site for two or three outlet operation.
- 360 degree handle rotation with three outlet operation.
- 120 degree handle rotation with two outlet operation.
- Complements the Purist® faucet and accessory collections.

Material

- Premium material construction with metal handle ensures reliability and durability.
- KOHLER finishes resist corrosion and tarnishing, exceeding industry durability standards.

Installation

- Trim set requires valve to complete installation.
- Patented K-joint installation technology ensures consistent trim appearance, regardless of variability in valve rough-in.

Required Accessories

K-728-K 3/4" Two- or Three-Way Transfer Valve

or

K-737-K 3/4" Two- or Three-Way Diverter Valve



ADA

Codes/Standards

ASME A112.18.1/CSA B125.1

ADA







ICC/ANSI A117.1

KOHLER® Faucet Lifetime Limited Warranty

See website for detailed warranty information.

Available Color/Finishes

Color tiles intended for reference only.

Color	Code	Description
	CP	Polished Chrome
	SN	Vibrant® Polished Nickel
	BGD	Vibrant® Moderne Brushed Gold
	BN	Vibrant® Brushed Nickel
	BV	Vibrant® Brushed Bronze
	BL	Matte Black

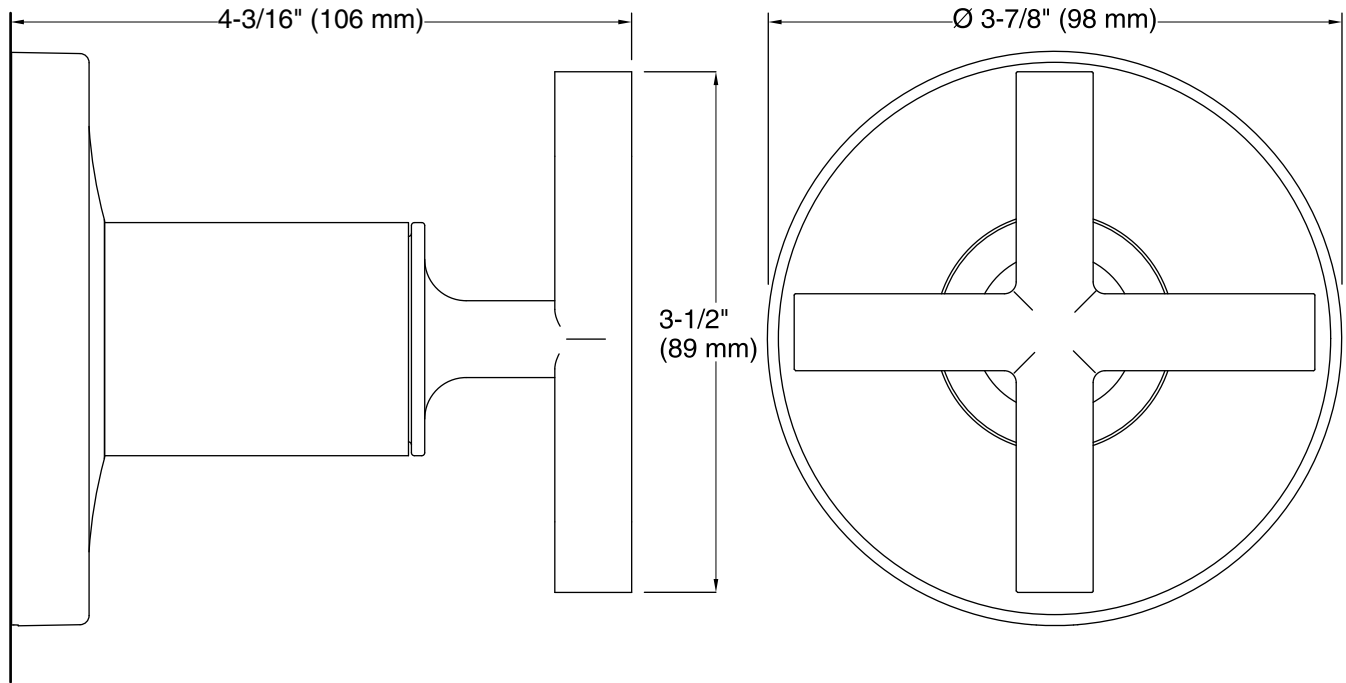

Technical Information

All product dimensions are nominal.

Notes

Install this product according to the installation instructions.

ADA compliant when installed to the specific requirements of these regulations.

Features

- Includes face plate with handle.
- Single handle controls both on/off activation and temperature setting.
- Supplied with ADA compliant metal cross handle.
- Complements the Purist faucet and accessory collections.

Material

- Premium material construction with metal handle ensures reliability and durability.
- KOHLER finishes resist corrosion and tarnishing, exceeding industry durability standards.

Installation

- Trim set requires valve to complete installation.

Required Accessories

K-304/K-P304 Series Rite-Temp® Valves

or

K-8304/K-P8304 Series Rite-Temp® Valve & Cartridge Kits

or

K-8300/K-P8300 Series Rite-Temp® Valve Body Rough-ins

K-8305/K-P8305 Series Rite-Temp® Cartridges

or

K-2971-KS 3/4" Pressure-balancing Valve

Optional Accessories

K-10350 Deep Rough-In Kit For K-8305 Cartridges

K-10351 Test Cap For K-8300 Series Valve Bodies



ADA

Codes/Standards

ASME A112.18.1/CSA B125.1

ADA





ICC/ANSI A117.1

KOHLER® Faucet Lifetime Limited Warranty

See website for detailed warranty information.

Available Color/Finishes

Color tiles intended for reference only.

Color	Code	Description
	CP	Polished Chrome
	SN	Vibrant® Polished Nickel
	BGD	Vibrant® Moderne Brushed Gold
	BN	Vibrant® Brushed Nickel
	BV	Vibrant® Brushed Bronze

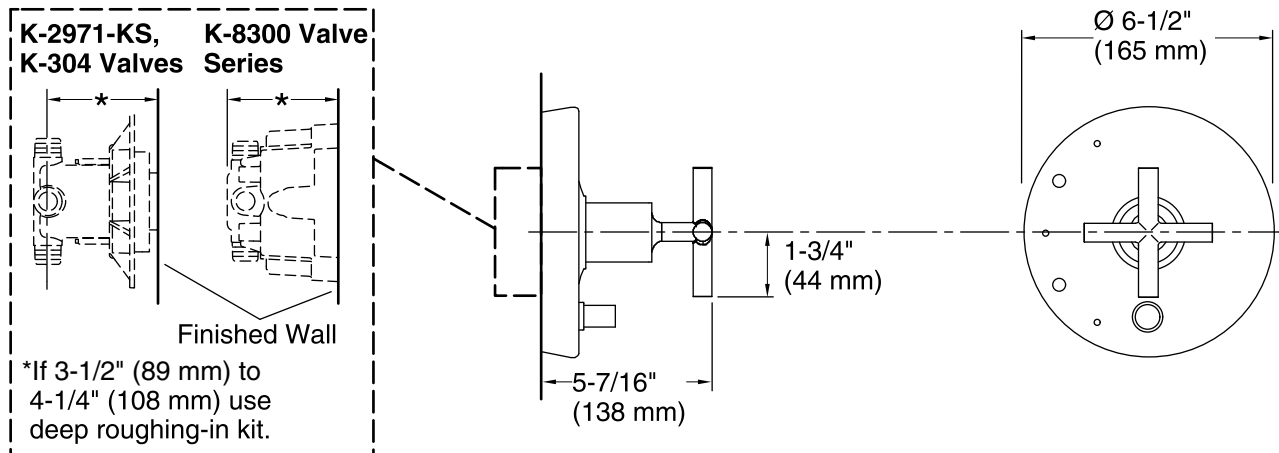

Technical Information

All product dimensions are nominal.

Notes

Install the product according to the installation guide.

NOTICE: Risk of product damage. Long screws for installing trim can damage the K-2971-KS valve. Consult the trim installation guide to verify if the thin wall installation kit (88526) is needed.

ADA compliant when installed to the specific requirements of these regulations.