

### Features

- One-piece toilets integrate the tank and bowl into a seamless, easy to clean design.
- Compact elongated bowl offers added comfort while occupying the same space as a round-front bowl.
- Concealed trapway facilitates easy cleaning and enhances design.
- Comfort Height® feature offers chair-height seating that makes sitting down and standing up easier for most adults.
- 1.28 gallons per flush (gpf).
- 2-1/8-inch glazed trapway.
- Standard left-hand Polished Chrome trip lever included.
- Reveal™ Quiet-Close™ seat with Quick-Release™ functionality allows seat to close quietly and quickly unlatch from the toilet for easy removal and convenient cleaning.
- Supply line not included.

### Technology

- Single-flush gravity uses the force of gravity and a precision-engineered tank, bowl, and trapway to create a strong siphon during flushing.
- AquaPiston canister allows water to flow into the bowl from all sides (360 degrees), increasing the power and effectiveness of the flush.
- Flush valve's 3:2 ratio harnesses the natural force of gravity and optimizes flush performance.
- Durable canister design has 90% less exposed seal material than a 3-inch flapper, for leak-free performance.
- Light-touch canister flush requires a lower actuation force than a flapper.

### Installation

- Standard 12-inch rough-in.

### Water Conservation & Rebates

- WaterSense® toilets meet strict EPA flushing guidelines, including using at least 20 percent less water than 1.6-gallon toilets.
- Eligible for consumer rebates in some municipalities.

### Optional Accessories

K-1954 Touchless Toilet Flush Kit  
 K-4108 Toilet Seat with Cleansing Functionality  
 K-4709 Toilet Seat with Cleansing Functionality  
 K-4737 Toilet Seat with Cleansing Functionality  
 K-7637 Angle Supply with Stop (single)  
 K-9171-L Trip Lever for K-5172



**ADA** **CSA B651** **OBC**

### Codes/Standards









ASME A112.19.2/CSA B45.1  
 DOE - Energy Policy Act 1992  
 EPA WaterSense®  
 California Energy Commission (CEC)  
 ADA  
 ICC/ANSI A117.1  
 CSA B651  
 OBC

### KOHLER® One-Year Limited Warranty

See website for detailed warranty information.

### Available Color/Finishes

*Color tiles intended for reference only.*

Color	Code	Description
	0	White
	96	Biscuit
	47	Almond
	NY	Dune
	95	Ice™ Grey
	G9	Sandbar
	33	Mexican Sand™
	K4	Cashmere

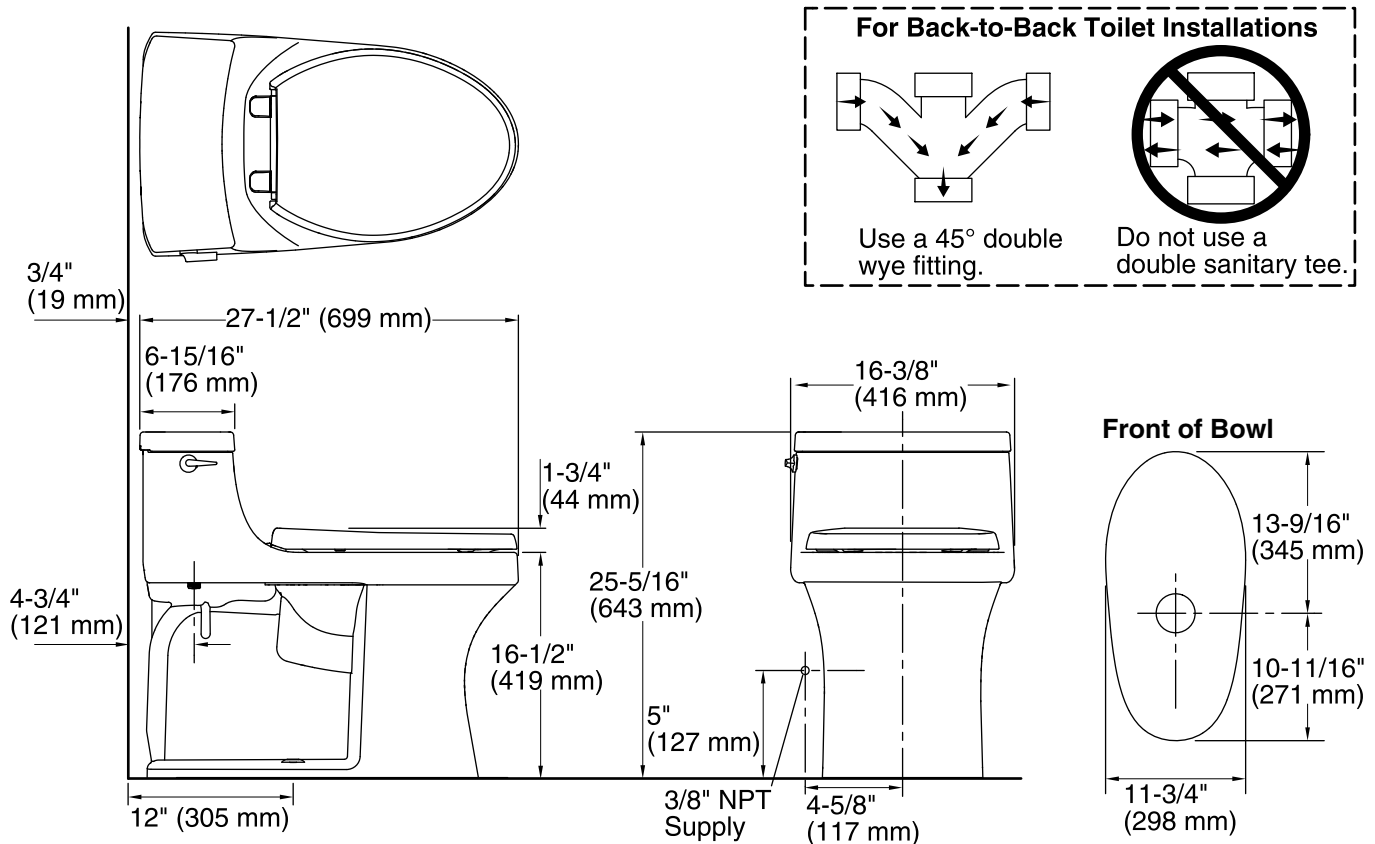

### Technical Information

All product dimensions are nominal.

Toilet type:	One-piece, Floor-mount
Waste Outlet:	Floor
Bowl shape:	Compact Elongated front
Flush type:	Class Five
Seat hinge type:	Quick-Attach®, Quiet-Close™
Trap passageway:	2-1/8" (54 mm)
Water Consumption	
Full:	1.28 gpf (4.8 lpf)
Water surface size:	10-3/4" x 7-1/2" (273 mm x 191 mm)
Rim to water surface:	5-3/8" (137 mm)
Rough-in:	12" (305 mm)
Seat-mounting holes:	5-1/2" (140 mm)

### Notes

Install this product according to the installation instructions.

For back-to-back toilet installations: Use only a 45° double wye fitting.

ADA, OBC, CSA B651 compliant when installed to the specific requirements of these regulations.

Plumbing Codes require elongated toilets and elongated, open-front toilet seats in public bathrooms.

Accessibility standards require controls to be located on the open side of the toilet.