

KOHLER® Faucets Bathroom sink faucet spout with Tube design, 1.2 gpm K-77967

Components®

Features

- 6 5/16" spout reach
- 1.2 gpm (4.5 lpm) maximum flow rate at 60 psi (4.14 bar)
- Laminar flow delivers a graceful stream of water
- Includes metal touch-activated drain with 1-1/4" tailpiece
- Coordinate with your choice of Components bathroom sink faucet handles for a personalized design
- This product can help a building earn Water Efficiency points in LEED® Green Building Rating System

Material

- Premium metal construction for durability and reliability
- KOHLER® finishes resist corrosion and tarnishing

Installation

- Widespread or remote valve

Required Products/Accessories

K-77974-4 Lever bathroom sink faucet handles

or

K-77974-8 Oyl bathroom sink faucet handles

or

K-77974-9 Industrial bathroom sink faucet handles

or

K-77963-8A Rocker bathroom sink faucet handle

Recommended Products/Accessories

K-23726 Drain treatment

K-23723 Faucet cleaner

K-78372 18" Towel Bar

K-78373 24" Towel Bar

K-78375 24" Double Towel Bar

K-78377 Hand Towel Arm

K-78378 Robe Hook

K-78379 Double Towel Arm

K-78382 Pivoting toilet paper holder

K-78383 Vertical toilet paper holder

K-78384 Covered double toilet paper holder



Codes/Standards

ASME A112.18.1/CSA B125.1

NSF/ANSI/CAN 61

NSF/ANSI/CAN 372

All applicable US Federal and State material regulations

DOE - Energy Policy Act 1992

EPA WaterSense®

California Energy Commission (CEC)







IAPMO Certification

KOHLER® Faucet Lifetime Limited Warranty

See website for detailed warranty information.

Available Colors/Finishes

Color tiles intended for reference only.

Color	Code	Description
	CP	Polished Chrome
	BN	Vibrant® Brushed Nickel
	BL	Matte Black
	2MB	Vibrant® Brushed Moderne Brass
	3RS	Vibrant® Ombré Rose Gold/Polished Nickel
	TT	Vibrant Titanium

1-800-4KOHLER (1-800-456-4537)

Kohler Co. reserves the right to make revisions without notice to product specifications.

For the most current Specification Sheet, go to www.kohler.com.USA

1-25-2024 12:01 - US

THE BOLD LOOK
OF **KOHLER**®

KOHLER Faucets Bathroom sink faucet spout with Tube design, 1.2 gpm K-77967

Components®

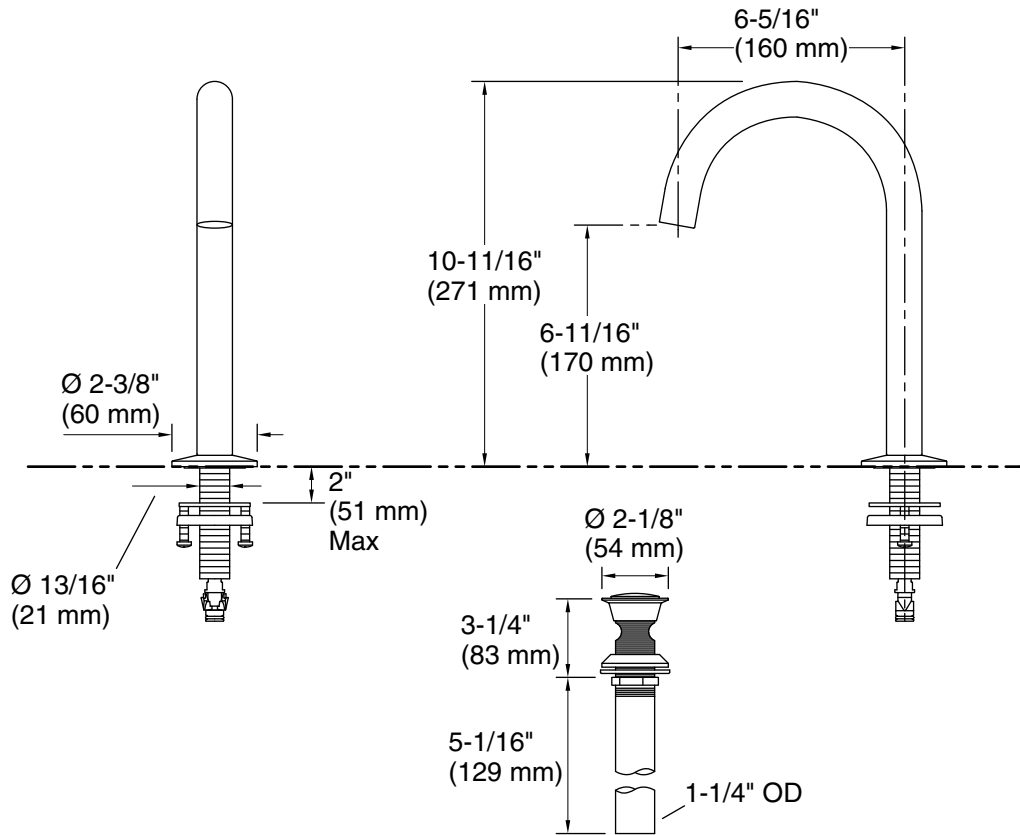

Technical Information

All product dimensions are nominal.

Faucet:

Flow rate: 1.2 gal/min (4.5 l/min)

Pressure: 60 psi (4.1 bar)

Drain included: Yes

Spout:

Spout reach: $6\text{-}5/16"$ (160 mm)

Notes

Install this product according to the installation instructions.