



Features

- Center drain.
- Slotted overflow allows for deep soaking.
- Dual lumbar supports two-person bathing by offering comfort at both ends

Material

- Acrylic

Hydrotherapy

- VibrAcoustic® technology emits sound waves and offers a surround sound experience.
- Six transducers and a control amplifier with 25' (7.6 m) of wiring.
- Fully adjustable volume above and below the water.
- Syncs with devices enabled with BLUETOOTH® wireless technology including smart phones, MP3 players, tablets and laptops located up to 33 feet away.*
- The BLUETOOTH® word mark and logos are registered trademarks owned by Bluetooth SIG, Inc. and any use of such marks by Kohler Co. is under license. Other trademarks and trade names are those of their respective owners.

Installation

- Drop-in

Required Accessories

K-7271 Brass Slotted Overflow Bath Drain

or

K-7272 PVC Slotted Overflow Bath Drain

Recommended Accessories

K-814 Under-mount Installation Kit

Components

Additional included component/s: 25' (7.6 m) cables.



Codes/Standards

CSA B45.5/IAPMO Z124

ASTM E162

ASTM E662

UL 1795

CSA C22.2 No. 218.2

Greenguard UL 2818 - Gold

CARB P2











KOHLER® One-Year Limited Warranty

See website for detailed warranty information.

*The BLUETOOTH® word mark and logos are registered trademarks owned by Bluetooth SIG, Inc. and any use of such marks by Kohler Co. is under license. Other trademarks and trade names are those of their respective owners.

Available Color/Finishes

Color tiles intended for reference only.

Color	Code	Description
	0	White
	96	Biscuit
	47	Almond
	NY	Dune
	95	Ice™ Grey
	G9	Sandbar
	33	Mexican Sand™
	K4	Cashmere
	58	Thunder™ Grey
	7	Black Black™

No change in measurements if connected with drain illustrated. (K-7272)

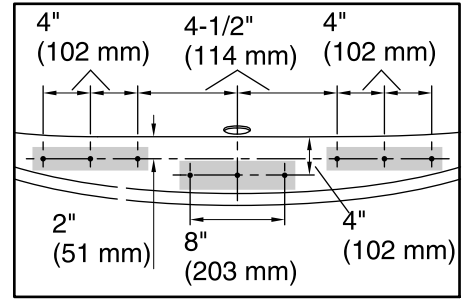
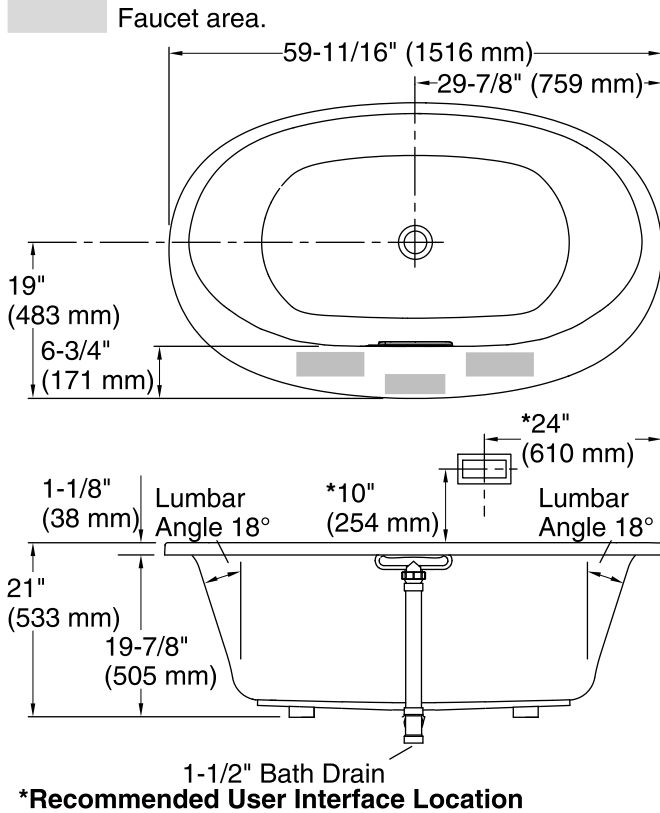

**Faucet Hole Locations
(For KOHLER® Brand Only)**

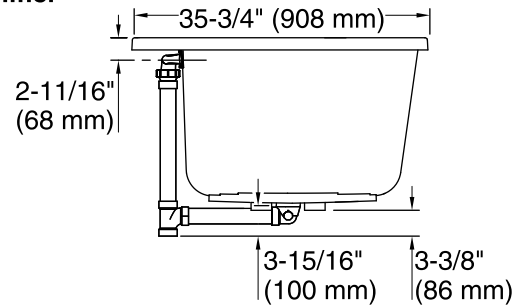
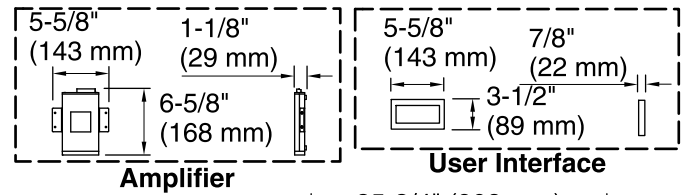

Required Electrical Service

One circuit required, protected with Class A Ground-Fault Circuit-Interrupter (GFCI) or Residual Current Device (RCD).

Amplifier: 120 V, 15 A, 50/60 Hz

Technical Information

All product dimensions are nominal.

Installation:	Drop-in, Under-mount
Drain location:	Center
Basin area, bottom:	43" x 25-5/8" (1093 mm x 651 mm)
Basin area, top:	55-9/16" x 28-3/8" (1411 mm x 720 mm)
Weight:	90 lbs (40.8 kg)
Minimum floor load:	49.2 lbs/ft ² (240.2 kg/m ²)
Water depth:	16-5/16" (415 mm)
Water capacity:	72.017 gal (272.6 L)
Template:	Drop-in, 1268438-7, required, included
Electrical component rating:	Amplifier: 120 V, 1.1 A, 50/60 Hz
Amplifier channels:	2 at 15 W per channel 2 at 30 W per channel

Notes

Measure your actual product for rough-in details.

Install this product according to the installation instructions.

The hot water supply should be 70% of the capacity of the bath or greater. Installations will vary.

Provide one grounded electrical outlet within 24" (610 mm) of each component.

Control amplifier fits 16" (406 mm) center studs.

Provide a separate grounded outlet if connecting to a powered wireless device or adapter.