

### Features

- Vitreous china.
- One-piece.
- Comfort Height® elongated bowl.
- AquaPiston® flushing system.
- Includes left-hand polished chrome trip lever.
- 1.28 gpf (4.8 lpf).
- 2-1/8" (54 mm) fully glazed trapway.
- 12" (305 mm) rough-in.
- Includes Reveal® Quiet-Close™ with Grip-Tight seat.
- Less supply.
- 12-7/8" (327 mm) x 11-1/2" (292 mm).
- 29-5/8" (752 mm) x 19" (483 mm) x 28-5/8" (727 mm).
- Floor mount/Floor outlet.

### Components

Product includes:

K-4008 Toilet Seat

Additional included component/s: Tank Cover, Low Profile Bolt Cap Accessory Pack, Tank Accessory Pack.



ADA

CSA B651

OBC

### Codes/Standards

ASME A112.19.2/CSA B45.1

DOE - Energy Policy Act 1992

EPA WaterSense®

California Energy Commission (CEC)

ADA

ICC/ANSI A117.1











CSA B651

OBC

See website for detailed warranty information.

### Available Color/Finishes

*Color tiles intended for reference only.*

Color	Code	Description
	0	White
	96	Biscuit
	47	Almond
	NY	Dune
	95	Ice™ Grey
	G9	Sandbar
	33	Mexican Sand™
	K4	Cashmere
	58	Thunder™ Grey
	7	Black Black™

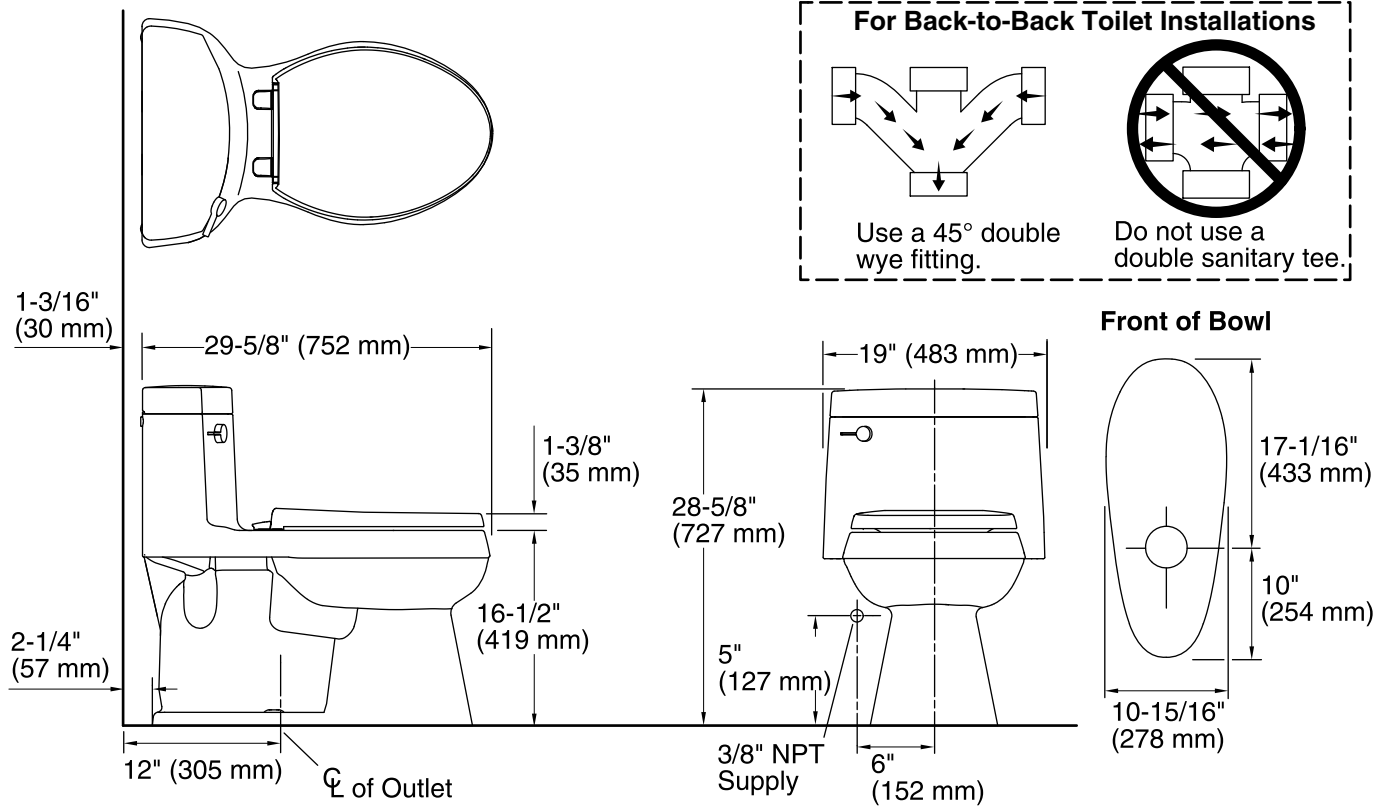

## Technical Information

All product dimensions are nominal.

Toilet type:	One-piece, Floor-mount
Waste Outlet:	Floor
Bowl shape:	Elongated front
Flush type:	AquaPiston
Trap passageway:	2-1/8" (54 mm)
Water Consumption	
Full:	1.28 gpf (4.8 lpf)
Water surface size:	12-1/2" x 10-1/2" (318 mm x 267 mm)
Rim to water surface:	5-1/2" (139 mm)
Rough-in:	12" (305 mm)
Seat-mounting holes:	5-1/2" (140 mm)

## Notes

Install this product according to the installation instructions.

For back-to-back toilet installations: Use only a 45 degree double wye fitting.

ADA, OBC, CSA B651 compliant when installed to the specific requirements of these regulations.

Plumbing Codes require elongated toilets and elongated, open-front toilet seats in public bathrooms.

Accessibility standards require controls to be located on the open side of the toilet.