

Features

- Brass construction

WALL-MOUNT SUPPLY ELBOW K-427

Codes/Standards Applicable

Specified model meets or exceeds the following:

- ASME A112.18.1/CSA B125.1

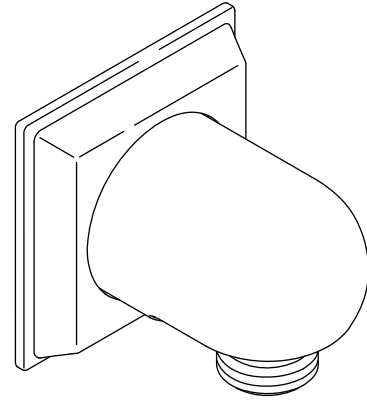

Colors/Finishes

- CP: Polished Chrome
- Other: Refer to Price Book for additional colors/finishes

Specified Model

Model	Description	Colors/Finishes	
K-427	Wall-mount supply elbow	<input type="checkbox"/> CP	<input type="checkbox"/> Other_____

Product Specification:

Supply elbow shall be of brass construction. Product is intended for wall-mount installations. Supply elbow shall be Kohler Model K-427-_____.

Technical Information

Applicable product:	
Wall-mount supply elbow	K-427

Installation Notes

Install this product according to the installation guide.

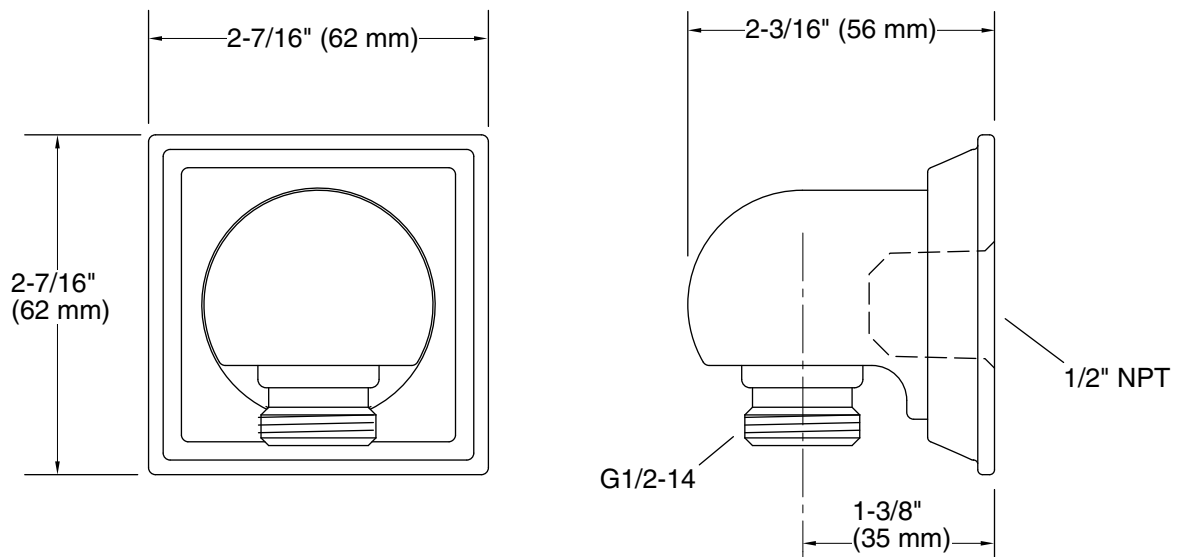

Product Diagram