

### Features

- Patented K-joint installation ensures consistent trim appearance, regardless of variability in valve rough-in
- Wall-mount installation
- Ergonomic lever handle is ADA-compliant
- Trim requires valve to complete

### Required Accessories

K- 728-K Three-Way/Two-Way Transfer Valve



ADA

CSA B651

OBC

### Codes/Standards

ASME A112.18.1/CSA B125.1

ADA

ICC/ANSI A117.1

CSA B651







OBC

### Kohler Faucet Lifetime Limited Warranty

See website for detailed warranty information.

### Available Color/Finishes

*Color tiles intended for reference only.*

| Color  | Code | Description              |
|--|------|--------------------------|
|  | CP   | Polished Chrome          |
|  | SN   | Vibrant® Polished Nickel |
|  | PB   | Vibrant® Polished Brass  |
|  | G    | Brushed Chrome           |
|  | BN   | Vibrant® Brushed Nickel  |
|  | BV   | Vibrant® Brushed Bronze  |
|  | BX   | Vibrant® Brazen Bronze   |

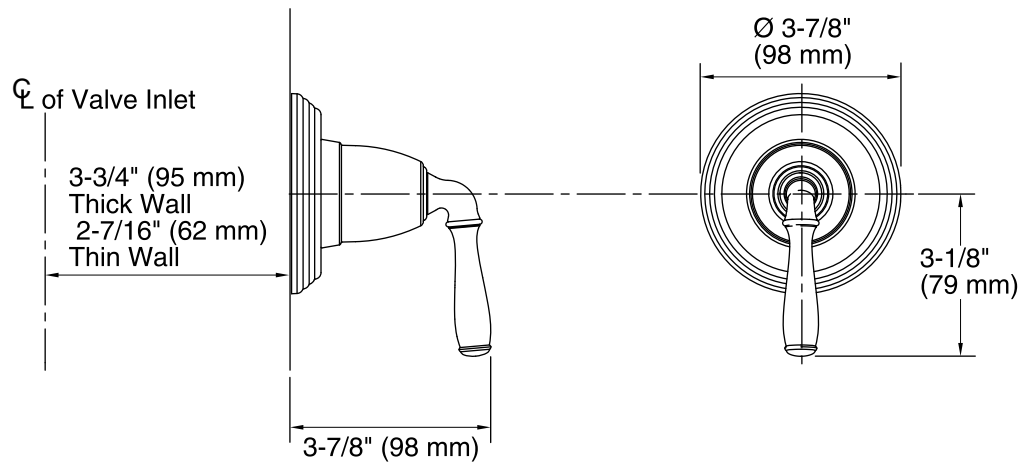

### Technical Information

All product dimensions are nominal.

### Notes

Install this product according to the installation guide.

ADA, OBC, CSA B651 compliant when installed to the specific requirements of these regulations.