

Features

- CleanCoat® technology creates a barrier between the water and glass to help keep your shower door looking new.
- Frameless, 5/16" (8 mm) thick Crystal Clear tempered glass door.
- No top header eliminates clearance issues.
- Frameless design emphasizes glass and creates a sleek, minimalist look.
- Self-closing mechanism offers superior performance and security against water leakage.

Material

- Anodized aluminum hardware prevents rusting or corrosion.

Installation

- Out-of-plumb adjustability allows for simpler installation.

Components

Additional included component/s: Hardware Kit.



Codes/Standards

ASTM C1036
ASTM C1048
ANSI Z97.1 (Tempered Glass)
CPSC 16CFR 1201

KOHLER® One-Year Limited Warranty

See website for detailed warranty information.

Available Color/Finishes

Color tiles intended for reference only.

Color	Code	Description
-------	------	-------------



SHP	Bright Polished Silver
-----	------------------------

ABZ	Anodized Dark Bronze
-----	----------------------



BNK	Anodized Brushed Nickel
-----	-------------------------

Available Glass Options

Code	Description
------	-------------

	Crystal Clear
--	---------------

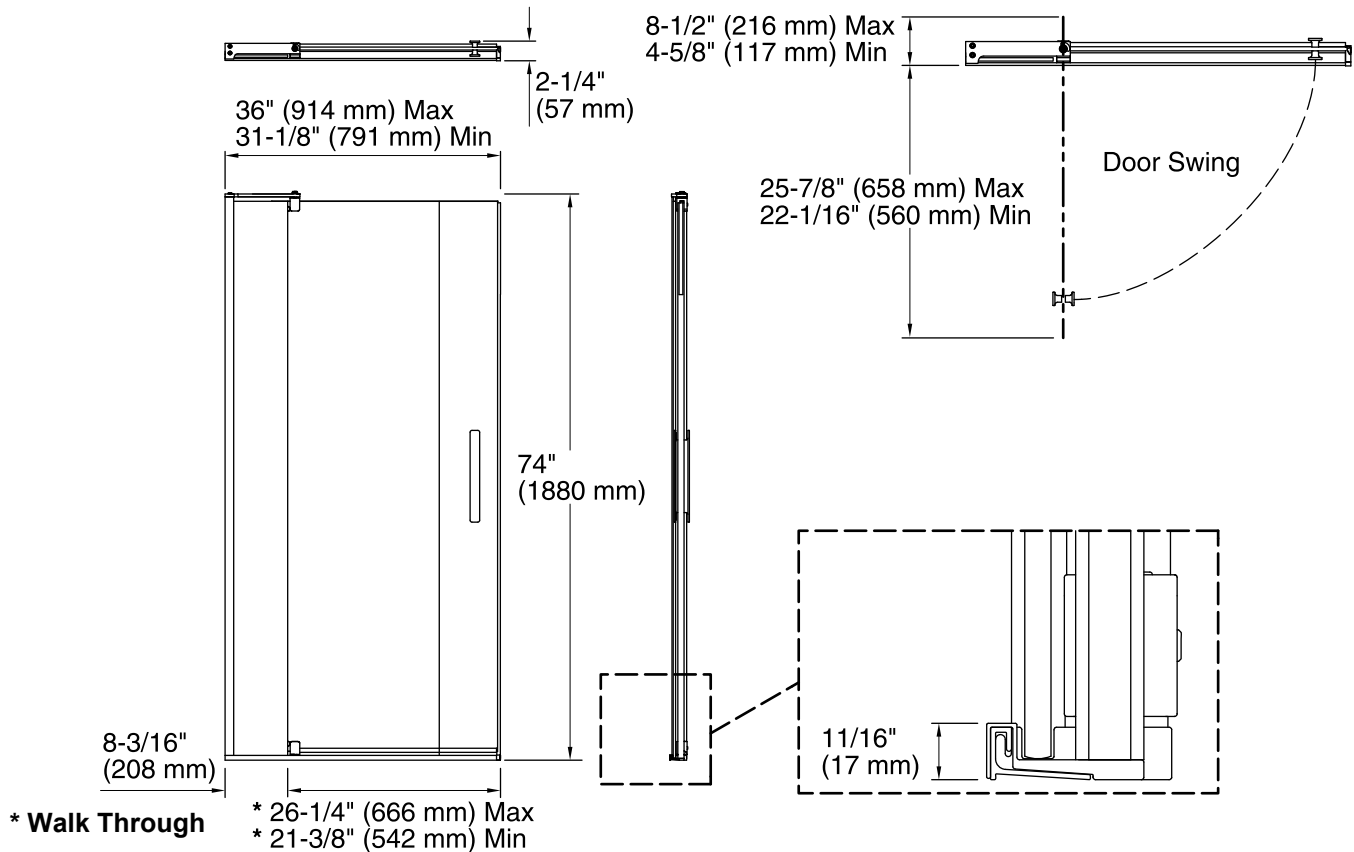

Technical Information

All product dimensions are nominal.

Installation type: For shower base installation

Opening style: Pivot

Opening Width - Min: 31-1/8" (791 mm)

Opening Width - Max: 36" (914 mm)

Walk-through - Min: 21-3/8" (542 mm)

Walk-through - Max: 26-1/4" (666 mm)

Glass thickness: 5/16" (8 mm)

Glass coating: CleanCoat®

Notes

Install this product according to the installation guide.

Strike jamb is made of clear plastic and may not cover existing shower door holes.

NOTICE: The vertical opening should be a minimum of 78" (2032 mm) to allow clearance for installation.