

### Features

- Vitreous china.
- Vanity-top.
- Rectangular basin.
- With overflow.
- Single faucet hole.
- Coordinates with other products in the Tresham collection.
- Also installs to 24" (610 mm) x 18" (457 mm) vanities.
- 25-7/16" (646 mm) x 19-1/16" (484 mm) x 7-7/8" (200 mm)

### Recommended Accessories

K-8998 P-Trap



### Codes/Standards











ASME A112.19.2/CSA B45.1

### KOHLER® One-Year Limited Warranty

See website for detailed warranty information.

### Available Color/Finishes

*Color tiles intended for reference only.*

Color	Code	Description
	0	White
	96	Biscuit
	47	Almond
	NY	Dune
	95	Ice™ Grey
	G9	Sandbar
	33	Mexican Sand™
	K4	Cashmere
	58	Thunder™ Grey
	7	Black Black™

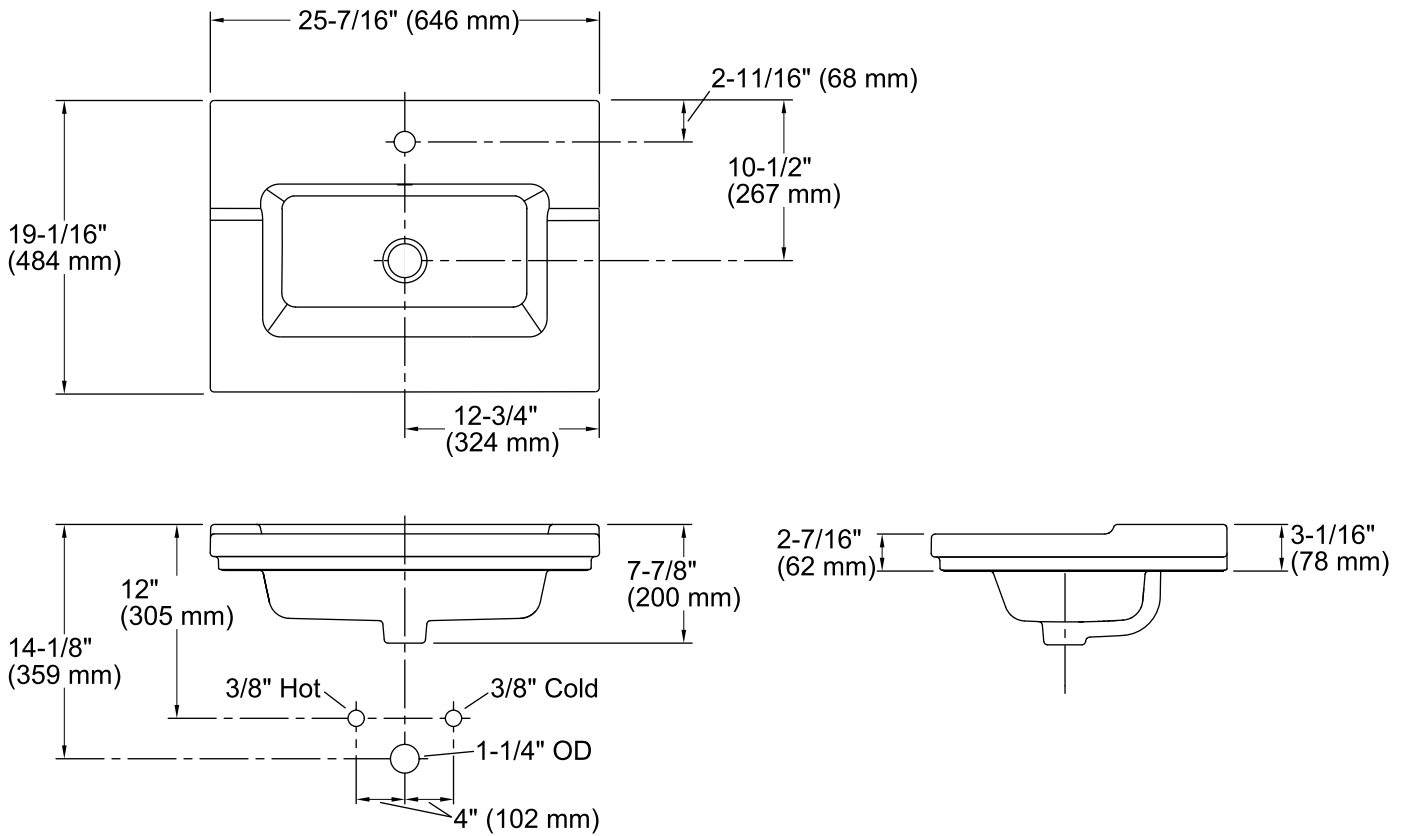

## Technical Information

All product dimensions are nominal.

Bowl configuration:	Single
Installation:	Vanity top
Bowl area (Only)	Length: 19-1/16" (484 mm) Width: 10-1/2" (267 mm) Water depth: 5-1/4" (133 mm)
Number of deck holes:	1
Faucet hole(s):	1-3/8" (35 mm)
Drain hole:	1-3/4" (44 mm)
Template:	Top-mount, 1162722-7, required, included

## Notes

Install this product according to the installation guide.

**NOTICE:** Countertop manufacturer or cutter must use the cut-out template provided with the product, or a current one provided by Kohler (call 1-800-4KOHLER). Kohler is not responsible for cutout errors when incorrect cut-out template is used.

When installing a pop-up drain to this bathroom sink, it may be necessary to bend the drain linkage to allow proper reach to the faucet lift rod.

**NOTE:** This bathroom sink is also designed for installation to the K-2604 vanity or with any other 24" (610 mm) x 18" (457 mm) vanity.