



Features

- Single-speed whirlpool offers performance and value, with 8 fully adjustable jets.
- Hydromassage flow and direction can be controlled at each jet.
- Built-in heater.
- Comfort Depth® design offers a convenient 19-inch step-over height while retaining the same depth as a standard 21-inch bath.
- Molded lumbar support offers extra comfort while bathing.
- Slotted overflow allows for deep soaking.
- Textured bottom surface
- Reversible drain.
- Coordinates with other products in the Archer collection.

Material

- Acrylic

Hydrotherapy

- Whirlpool

Installation

- Drop-in

Additional Hydrotherapy Options

- Soaking Bath - K-1948-0
- Soaking Bath + Bask heated surface - K-1948-W1
- BubbleMassage air bath - K-1949-G
- BubbleMassage air bath + Bask heated surface - K-1949-GW
- VibrAcoustic - K-1949-VB
- VibrAcoustic + Bask heated surface - K-1949-VBW
- Whirlpool - K-1949-0
- Whirlpool + heater - K-1949-H
- Whirlpool + Bask heated surface - K-1949-W1
- Whirlpool + BubbleMassage air bath - K-1949-XHG

Required Accessories

K-7271 Brass Slotted Overflow Bath Drain

or

K-7272 PVC Slotted Overflow Bath Drain

Recommended Accessories

K-24916 Wireless Music Kit



ADA

Codes/Standards

ASME A112.19.7/CSA B45.10

CSA B45.5/IAPMO Z124

UL 1795

CSA C22.2 No. 218.2

Greenguard UL 2818 - Gold

ADA

ICC/ANSI A117.1

KOHLER® Plastic Baths and Receptors Lifetime Limited Warranty







KOHLER® Hydrotherapy Components Five-Year Limited Warranty

See website for detailed warranty information.

Available Color/Finishes

Color tiles intended for reference only.

Color Code Description

	0	White
	96	Biscuit
	47	Almond
	NY	Dune
	95	Ice™ Grey
	G9	Sandbar

No change in measurements if connected with drain illustrated. (K-7272)

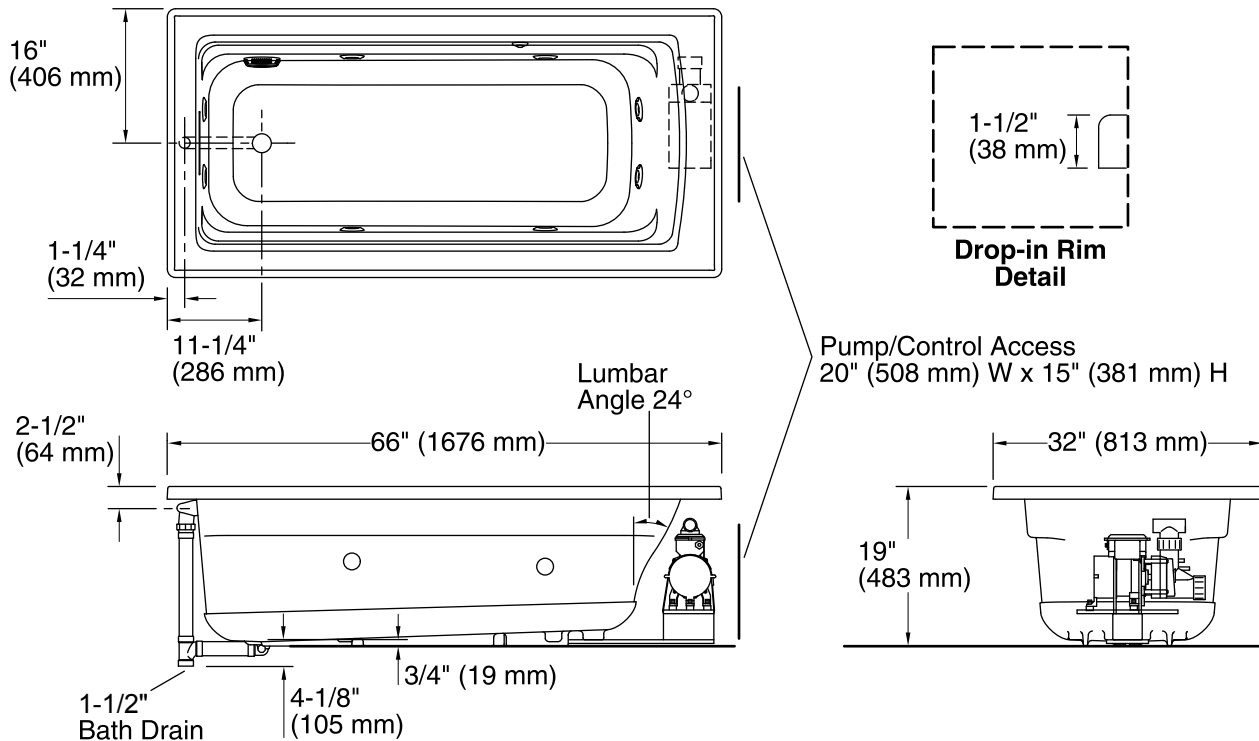

Required Electrical Service

Two dedicated circuits required, protected with Class A Ground-Fault Circuit-Interrupter (GFCI) or Residual Current Device (RCD).

Pump: 120 V, 15 A, 60 Hz
Heater: 120 V, 15 A, 60 Hz

Technical Information

All product dimensions are nominal.

Installation: Drop-in
Drain location: Reversible
Basin area, bottom: 50-3/8" x 19-5/8" (1280 mm x 498 mm)
Basin area, top: 57-5/16" x 24-1/16" (1456 mm x 611 mm)
Weight: 106 lbs (48.1 kg)
Minimum floor load: 47 lbs/ft² (229.5 kg/m²)
Water depth: 15-5/16" (389 mm)
Water capacity: 33 gal (124.9 L)
Cutout: Drop-in, 64-1/2" x 30-1/2" (1638 mm x 775 mm) with (mm) radius corners
Electrical component rating: Pump: 120 V, 7.0 A, 60 Hz
Heater: 120 V, 12.5 A, 60 Hz, 1500 W
Minimum flat for door: 2-3/16" (55 mm)

Notes

Measure your actual product for rough-in details. Install this product according to the installation instructions.

The hot water supply should be 70% of the capacity of the bath or greater. Installations will vary.

This product is designed for drop-in installation only. It is not suited for use in a three-wall alcove with an overhead shower.

ADA compliant when installed to the specific requirements of these regulations.