

MODEL: 93541ORB
PACKING DIAGRAM

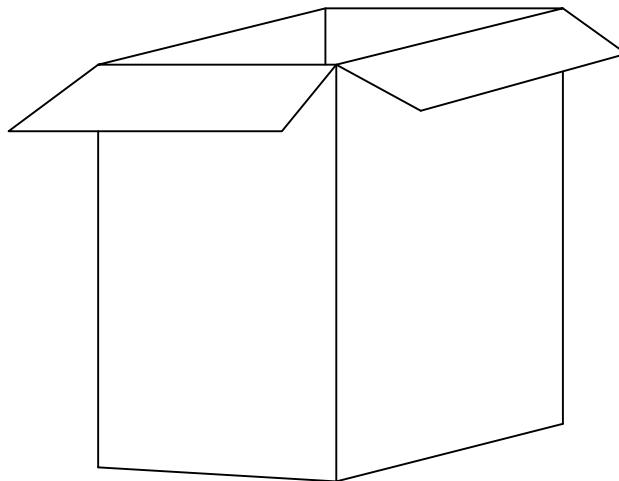

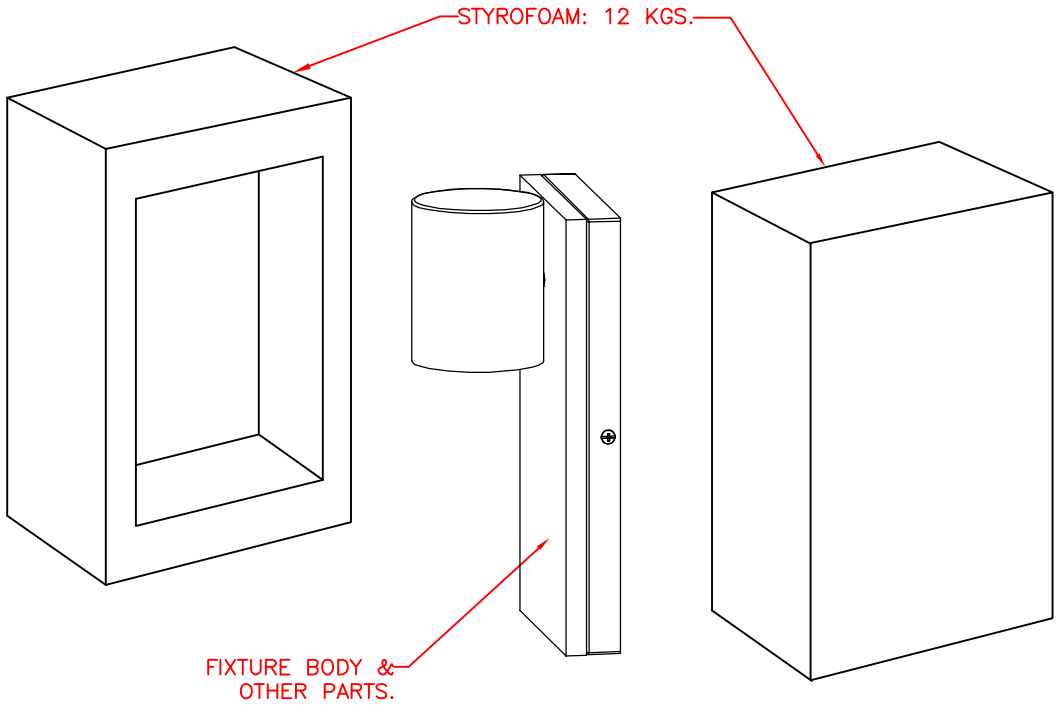
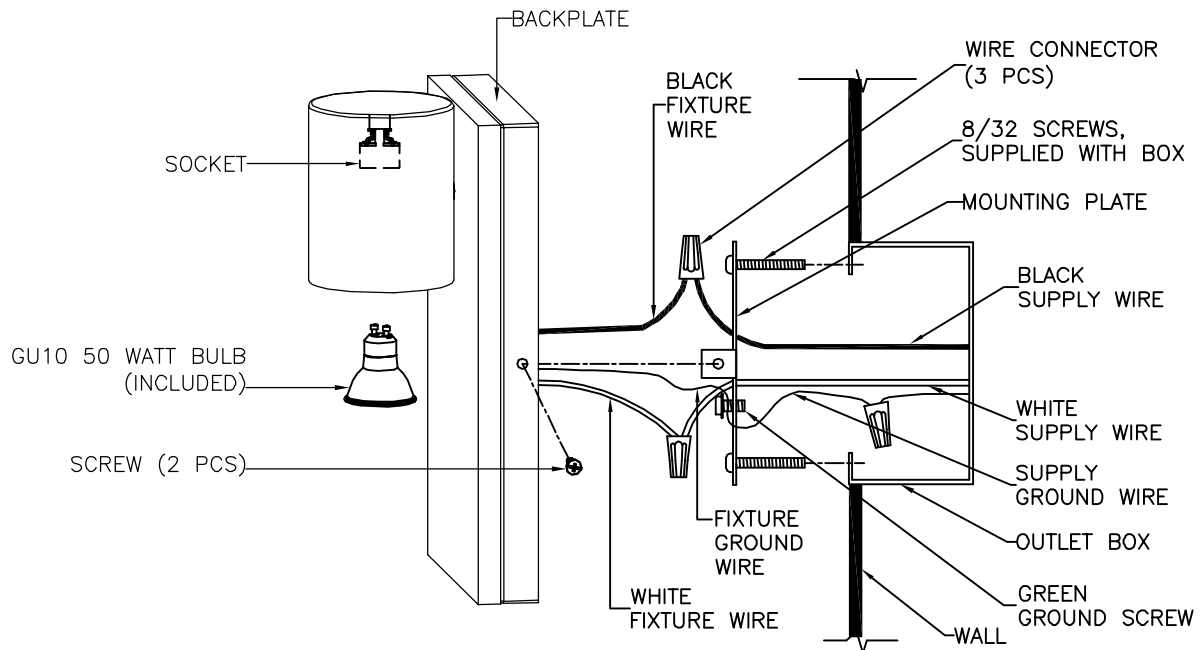

INSTALLATION INSTRUCTIONS

READ AND SAVE THESE INSTRUCTIONS

CAUTION: TO AVOID POSSIBLE ELECTRIC SHOCK, MAKE SURE THE ELECTRICITY IS SHUT OFF AT THE MAIN PANEL. IF YOU ARE REPLACING AN EXISTING FIXTURE, FIRST TURN THE FIXTURE OFF. NEXT, TURN THE WALL SWITCH OFF. FINALLY, GO TO THE MAIN FUSE OR BREAKER BOX IN YOUR HOME. TURN THE FUSE OR BREAKER TO THE OFF POSITION. SOME TYPES OF FUSES MUST BE UNSCREWED TO SHUT OFF THE POWER.

* ALL WIRING MUST BE DONE IN ACCORDANCE WITH NATIONAL AND LOCAL ELECTRIC CODES.

** IF YOU DO NOT HAVE ELECTRICAL WIRING EXPERIENCE, HAVE YOUR FIXTURE INSTALLED BY A QUALIFIED LICENSED ELECTRICIAN.

*** THIS FIXTURE IS TO BE MOUNTED TO A UL LISTED OUTLET BOX CAPABLE OF SUPPORTING THE WEIGHT OF THIS FIXTURE. THE OUTLET BOX MUST BE DIRECTLY SUPPORTED BY THE BUILDING STRUCTURE.

TOOLS: YOU WILL NEED THE FOLLOWING TOOLS OR EQUIPMENT: SCREWDRIVER, PLIERS, ADJUSTABLE WRENCH.

UNPACK THE FIXTURE

YOU SHOULD HAVE RECEIVED THE BULB AND FIXTURE BODY IN THE PACKAGE, TO PROTECT THE FINISH, PLACE THE FIXTURE BODY ON A SOFT SURFACE.

HARDWARE PACK: (2) 8/32 x 1-1/4" SCREWS AND (3) WIRE CONNECTORS.

INSTALL THE FIXTURE

1. REMOVE THE MOUNTING PLATE FROM BACK OF THE BACKPLATE BY UNSCREWING (2) SCREWS.
2. ATTACH THE MOUNTING PLATE TO OUTLET BOX USING TWO SCREWS PROVIDED WITH THE OUTLET BOX, MAKE SURE ONE OF THE BRACKET OF THE MOUNTING PALTE FACING RIGHT. (NOTE: IF THE SCREWS WITH THE OUTLET BOX ARE TOO SHORT, USE THE (2) 8-32 x 1-1/4" SCREWS PROVIDED IN THE MOUNTING HARDWARE PACKAGE).
3. CONNECT THE WHITE OR RIBBED FIXTURE WIRE TO THE WHITE SUPPLY WIRE IN THE OUTLET BOX USING THE TWIST-ON WIRE CONNECTOR PROVIDED. CONNECT THE BLACK OR SMOOTH FIXTURE WIRE TO THE BLACK SUPPLY WIRE IN THE SAME MANNER. INSTALL THE FIXTURE GROUND WIRE UNDER THE GREEN GROUND SCREW ON THE MOUNTING PLATE THEN CONNECT THE FIXTURE GROUND WIRE TO THE SUPPLY GROUND WIRE IN THE OUTLET BOX USING THE TWIST-ON WIRE CONNECTOR PROVIDED.
4. RAISE THE FIXTURE BODY TO THE WALL AND CAREFULLY TUCK THE WIRES INSIDE THE OUTLET BOX. SPREAD THE ELECTRICAL SPLICES SO THAT THE BLACK WIRES ARE ON ONE SIDE OF THE OUTLET BOX AND THE WHITE WIRES ARE ON THE OTHER SIDE. LINE UP SCREWS WITH HOLES IN BACKPLATE AND SECURE WITH (2) SCREWS REMOVED ABOVE.
5. INSTALL A 50 WATT MAXIMUM TYPE "GU10" BULB (INCLUDED) INTO THE SOCKET.
6. RESTORE POWER, YOUR NEW FIXTURE IS NOW READY FOR USE.

