

PEDESTAL SINK

1. Locate the pedestal sink in the most suitable location.

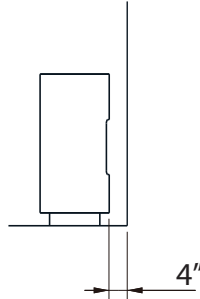

2. Mark the screw holes on the floor.

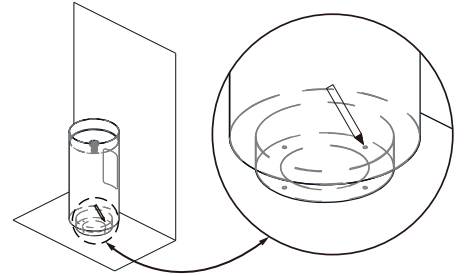

3. Drill starter holes for the screws. Install the waste and attach plumbing to sink prior to the next step.

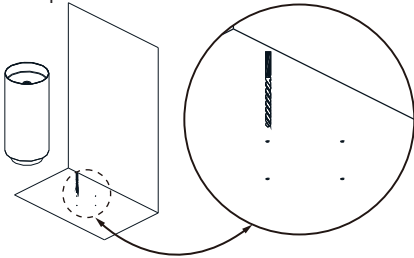

4. Apply a clear silicone to base of sink. Place in correct position and fasten screws.

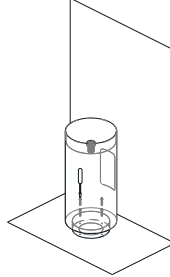

5. Connect the plumbing to the wall connection.

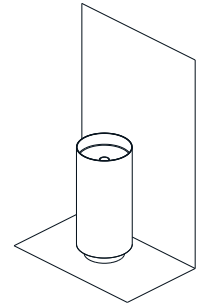

VESSEL SINK

1. Place the vessel sink on the countertop and mark the position of the waste.

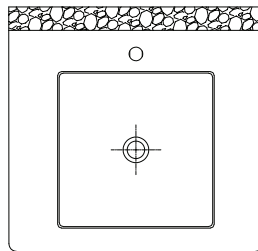

2. Drill the waste hole with suitable tools according to the countertop material.

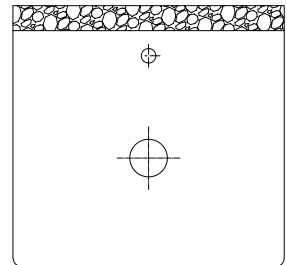

3. Apply clear silicone around the bottom of the sink.

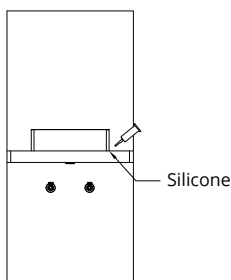

4. Install the waste to the sink.

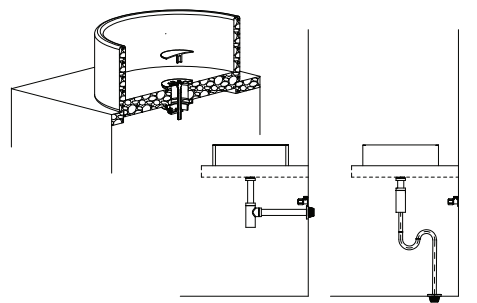

INSTALLATION MANUAL

UNDERMOUNT SINK

1. Use the template provided or the DXF file to create the cutout in the countertop. It is recommended to have a 1/8" to 1/4" overhang.

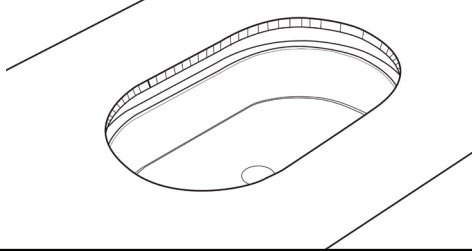

2. Apply clear silicone to the rim of the undermount sink.

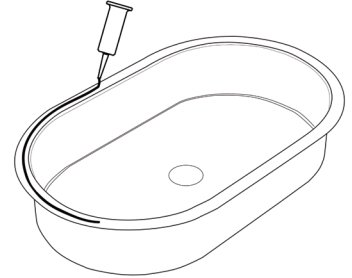

3. Use supplied clips or your own preferred clamping system to secure the sink to the underside of the countertop opening. Make sure it is accurately aligned to the cutout opening.

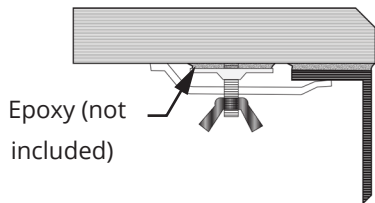

4. Wipe up excess silicone.

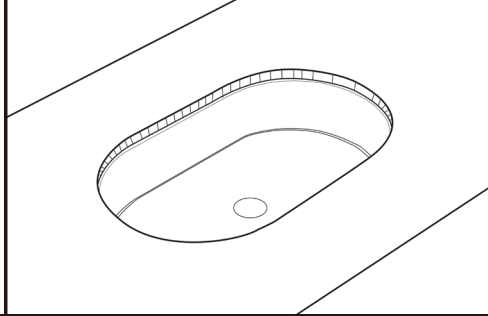

TOP MOUNT SINK

1. Locate the sink upside down in the most suitable position on the countertop. Trace around the perimeter of the sink with pencil.

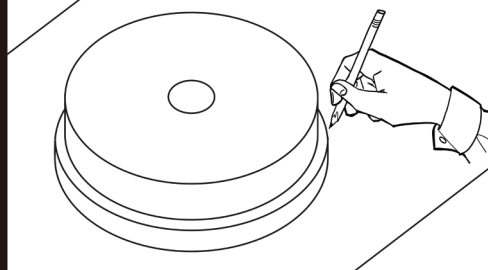

2. Draw a line 1/4" inside of the outline of the sink.

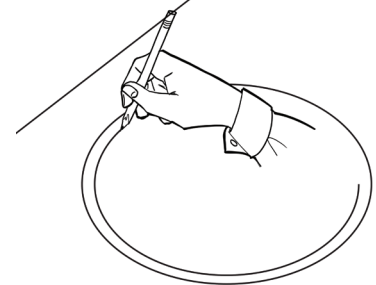

3. Use the appropriate saw to cut on the inside line.

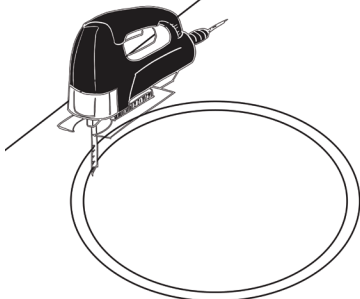

4. Apply silicone around cutout in the countertop surface. Lower sink into position. Place weight in sink for 24 hours while silicone cures.

