

---

## INSTALLATION INSTRUCTIONS



**P70300**

## INSTALLATION INSTRUCTIONS

### THANK YOU FOR CHOOSING KALLISTA

We appreciate your commitment to KALLISTA quality products. Please take a moment to review this manual before you install your KALLISTA product. If you encounter any installation or performance problems, please do not hesitate to contact us at the phone number listed at the bottom of the page.

### IMPORTANT INFORMATION

**⚠ CAUTION: Risk of personal injury.** If the new toilet is not installed immediately, temporarily place a rag in the closet flange. Hazardous gases may leak from the flange opening if it is not blocked.

**⚠ CAUTION: Risk of product damage.** Do not use cement or plaster to seal the foot of the bowl to the floor, as this can damage the product and void the warranty. If sealing the foot of the bowl, use only silicone or latex based adhesives.

**IMPORTANT!** Do not lift or rock the bowl after placement. If you break the watertight seal, you must install a new wax seal.

**NOTE:** The toilet pictured in the installation steps may differ from the model being installed.

- Observe all local plumbing and building codes.
- KALLISTA reserves the right to make revisions in the design of products without notice, as specified in the Price Book.

### TOOLS AND MATERIALS

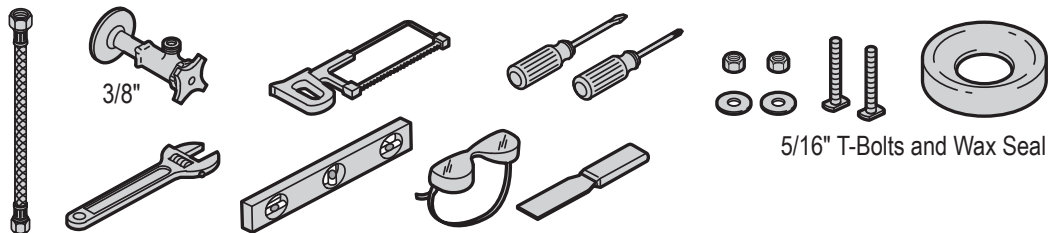

## INSTALLATION INSTRUCTIONS

### INSTALLATION

- 1.** If replacing a toilet, remove the old wax.

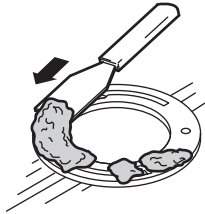

- 2.**

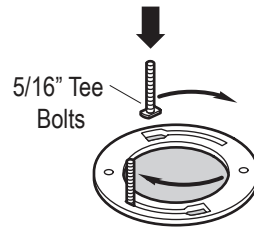

- 3.**

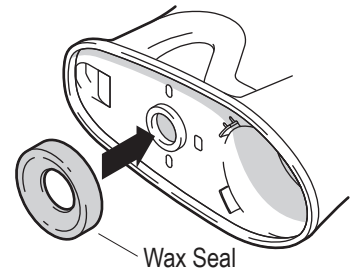

- 4.**

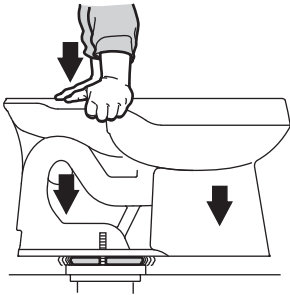

Apply weight evenly.  
Do not move after placement!  
Watertight seal may be broken!

- 5.** Do not overtighten!

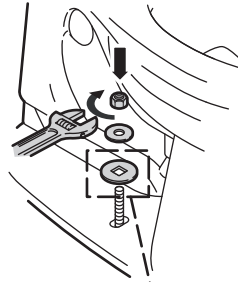

This side up.



- 6.**

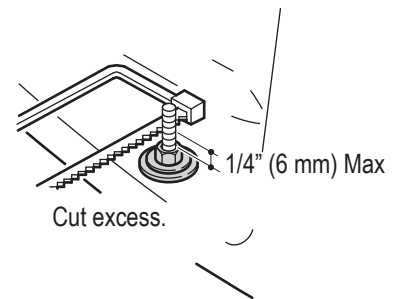

- 7.**

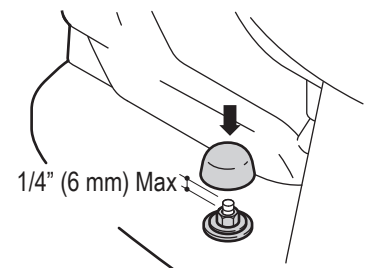

## INSTALLATION INSTRUCTIONS

### INSTALLATION

8.

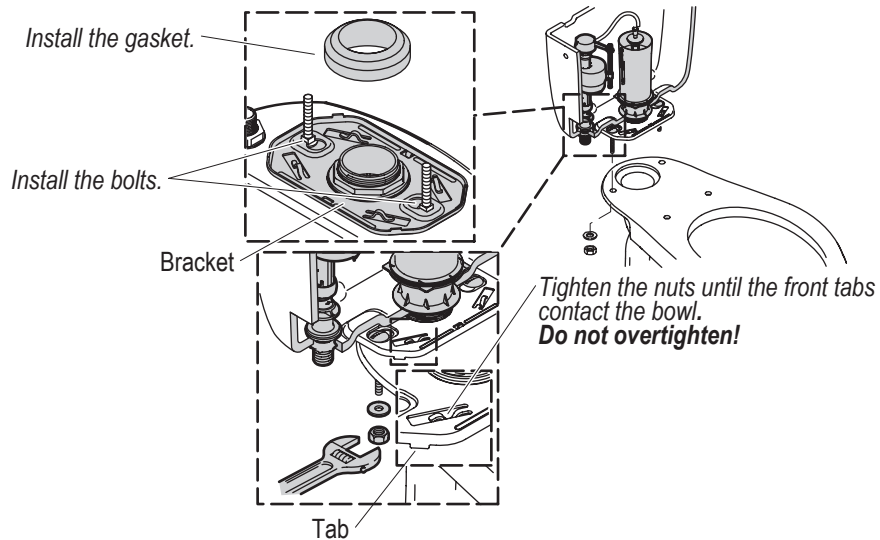

9.

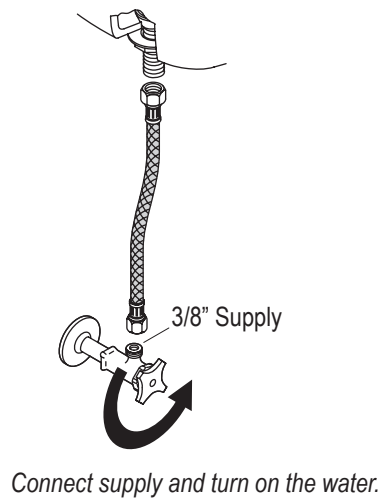

10. Flush several times and check for leaks.  
**Do not overtighten!**

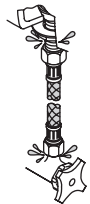

11. Turn here to adjust the water level.

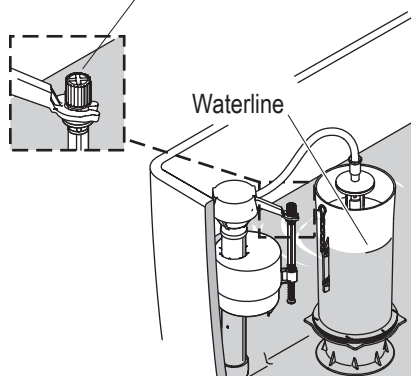

12. Install the tank lid and the seat.

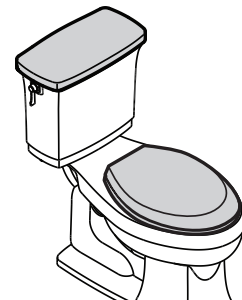

## INSTALLATION INSTRUCTIONS

TROUBLESHOOTING GUIDE	
SYMPTOMS	Recommended Action
1. Poor flush.	<ul style="list-style-type: none"> <li>A. Adjust the tank water level to match the waterline.</li> <li>B. Fully open the water supply shut-off valve.</li> <li>C. Clear obstructions from the trapway, jet, or bowl rim holes.</li> <li>D. Clear obstructions from the waste line.</li> </ul>
2. No flush.	<ul style="list-style-type: none"> <li>A. Reconnect the chain to the trip lever or flush valve.</li> <li>B. Adjust the chain assembly to remove excessive slack.</li> </ul>
3. The fill valve turns on/off by itself without the toilet being flushed, or it runs allowing water to enter the tank.	<ul style="list-style-type: none"> <li>A. Adjust the chain for proper slack so the seal is not held off the flush valve seat.</li> <li>B. Clean or replace the seal if it is worn, dirty, or misaligned with the flush valve seat, or if the flush valve seat is damaged. Replace the flush valve seal or flush valve.</li> <li>C. Clean the fill valve seat/seat washer of debris, or replace the piston/seat washer assembly.</li> <li>D. Remove the tank and tighten the flush valve nut if flush valve gasket is leaking. Do not overtighten. If leakage continues, replace the gasket.</li> <li>E. Replace the fill valve if the valve float sinks.</li> <li>F. Adjust the tank water level if it is too high.</li> </ul>
4. Tank takes excessive time to fill.	<ul style="list-style-type: none"> <li>A. Fully open the water supply shut-off valve.</li> <li>B. Clean the valve inlet, valve head, or supply line. Flush the lines.</li> </ul>
5. There is excessive noise when the tank is filling.	<ul style="list-style-type: none"> <li>A. Partially close the water supply shut-off valve if the water pressure to the toilet is too high. Check the toilet performance following any such adjustment</li> <li>B. Remove dirt or obstructions from the valve head. Flush the lines.</li> </ul>

## INSTALLATION INSTRUCTIONS

### SERVICE PARTS

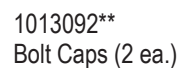
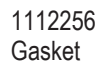
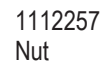
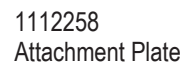
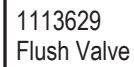
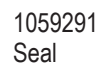
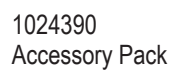
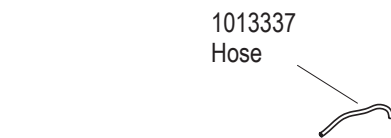
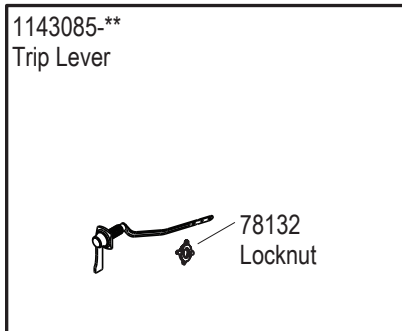

\*\*Finish/color code must be specified when ordering.