

Features

- A selection of products within this collection is in stock and ready to ship. Please visit kallista.com/resources/#ReadyToShip for the complete list of Ready-to-Ship products and finishes
- High-quality solid-brass construction for durability and reliability
- Spout reach is 5-15/16" (151 mm)
- 1.8 gpm (6.8 lpm) maximum flow rate
- Two-hole installation
- Joystick handle
- 4" (102 mm) minimum, 8" (203 mm) maximum distance between spout and handle
- Sink strainer with tailpiece sold separately

Recommended Products/Accessories

- L20513-00 24" Apron-front Butler Sink
- P25215-00 Soap/Lotion Dispenser
- P34000-00 Sink strainer
- P25200-00 Pull-Down Kitchen Faucet



ADA

Codes/Standards









ASME A112.18.1/CSA B125.1
DOE - Energy Policy Act 1992
California Energy Commission (CEC)
ADA
ICC/ANSI A117.1

KALLISTA® Five-Year Limited Warranty

See website for detailed warranty information.

Available Colors/Finishes

Color tiles intended for reference only.

Color	Code	Description
	AD	Nickel Silver
	CP	Polished Chrome
	AG	Brushed Nickel
	GN	Gunmetal
	BL	Matte Black
	ULB	Unlacquered Brass
	BGP	Brushed Graphite
	PGP	Polished Graphite
	2MB	Brushed Moderne Brass

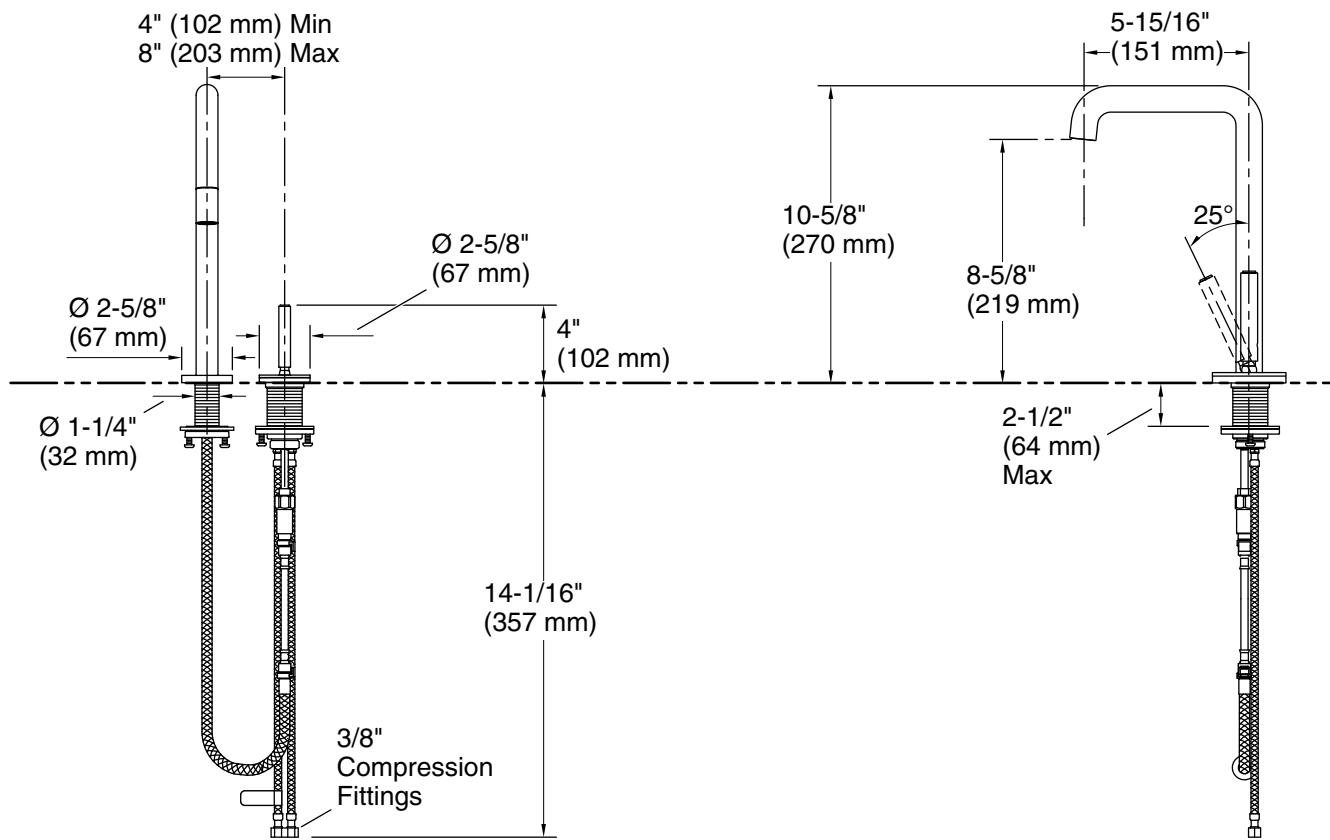

Technical Information

All product dimensions are nominal.

Faucet flow rate: 1.75 gal/min (6.6 l/min)

Spout:

Spout reach: 5-15/16" (151 mm)

Notes

ADA compliant when installed to the specific requirements of these regulations.