

# KALLISTA®

Per Se® by KALLISTA  
Single-control sink faucet  
P26625-00

## Features

- High-quality solid-brass construction for durability and reliability
- Spout reach is 4-7/8" (124 mm)
- Spout height is 6-1/2" (165 mm)
- Includes metal pop-up drain with 1-1/4" metal tailpiece
- Single-hole installation
- 1.2 gpm (4.5 lpm) maximum flow rate
- A selection of products within this collection is in stock and ready to ship. Please visit [kallista.com/resources/#ReadyToShip](http://kallista.com/resources/#ReadyToShip) for the complete list of Ready-to-Ship products and finishes



## Recommended Products/Accessories

- P34706-00 Hook
- P24669-00 Towel ring
- P34700-00 Towel Bar, 24"
- P34702-00 Towel Bar, 12"
- P34701-00 Towel Bar, 18"
- P34708-00 Toilet Paper Holder



**ADA** **CSA B651** **OBC**

## Codes/Standards







ASME A112.18.1/CSA B125.1  
NSF/ANSI/CAN 61  
NSF/ANSI/CAN 372  
DOE - Energy Policy Act 1992  
EPA WaterSense®  
California Energy Commission (CEC)  
ADA  
ICC/ANSI A117.1  
CSA B651  
OBC

## KALLISTA® Five-Year Limited Warranty

See website for detailed warranty information.

## Available Colors/Finishes

*Color tiles intended for reference only.*

Color	Code	Description
	CP	Polished Chrome
	AF	French Gold
	BAF	Brushed French Gold
	BN	Brushed Nickel
	SN	Polished Nickel
	BV	Brushed Bronze

1-888-4-KALLISTA (1-888-452-5547)

Kallista reserves the right to make revisions without notice to product specifications.

For the most current Specification Sheet, go to [www.kallista.com](http://www.kallista.com).

5-29-2026 22:59 - US

# KALLISTA

Per Se<sup>®</sup> by KALLISTA  
Single-control sink faucet  
P26625-00

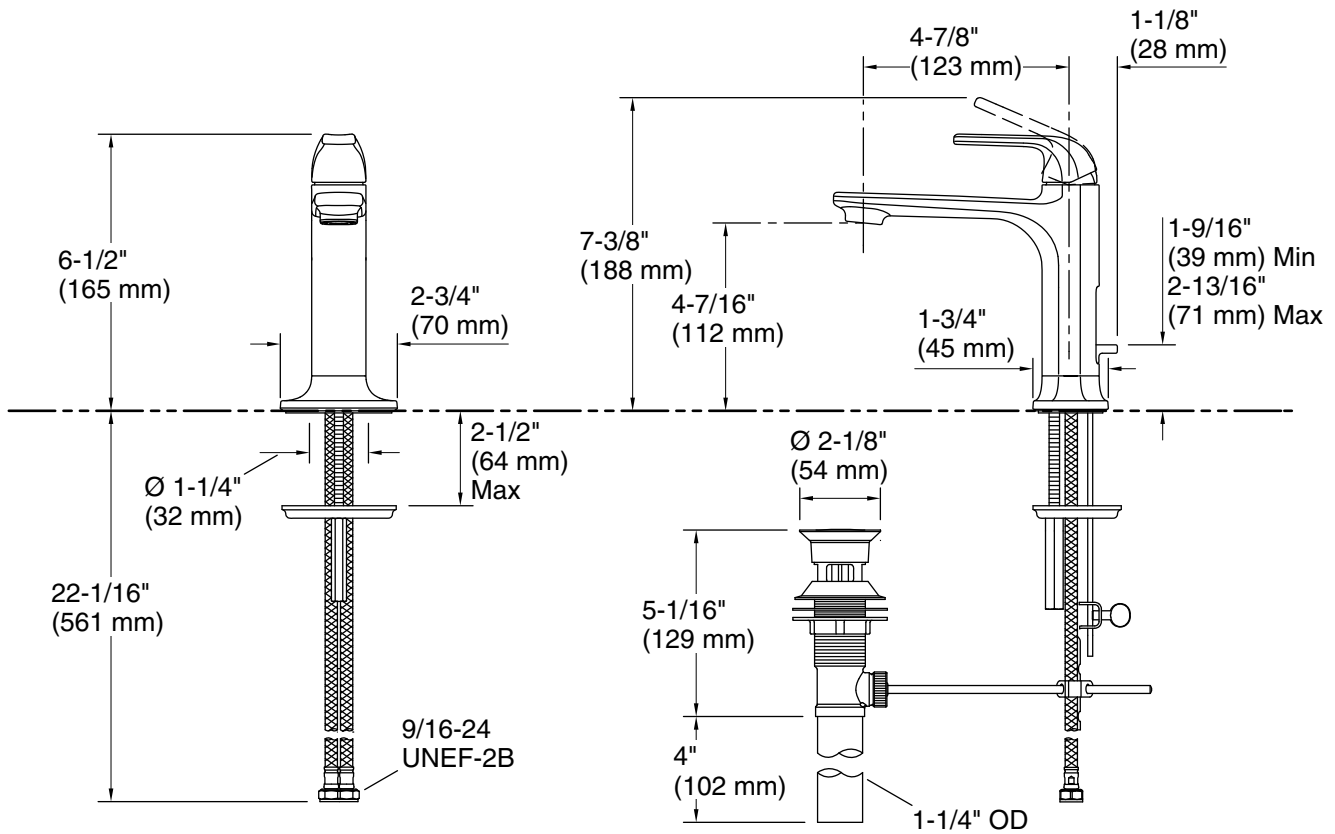

## Technical Information

All product dimensions are nominal.

Faucet flow rate: 1.2 gal/min (4.5 l/min)

Drain included: Yes

Drain with overflow: Yes

Spout:

Spout reach: 4-7/8" (123 mm)

## Notes

ADA, OBC, CSA B651 compliant when installed to the specific requirements of these regulations.