

Features

- A selection of products within this collection is in stock and ready to ship. Please visit kallista.com/resources/#ReadyToShip for the complete list of Ready-to-Ship products and finishes
- High-quality solid metal construction for durability and reliability
- Required rough-in sold separately
- Precise temperature setting capability
- Patented K-joint installation ensures consistent trim appearance



Required Products/Accessories

- P29511-WS 1/2" Thermostatic Mixing Valve
- or
- P29512-WS 3/4" Thermostatic Mixing Valve
- or
- P25023-LV Script Volume Control Trim, Lever Handle

Recommended Products/Accessories

- P25018-LV Script Pressure Balance Trim, Lever Handle
- P25024-LV Transfer Trim, Lever Handle
- P25040-00 Showerhead with Arm
- P25043-00 Towel Bar, 18"

ADA **CSA B651** **OBC**

Codes/Standards







ASME A112.18.1/CSA B125.1
ADA
ICC/ANSI A117.1
CSA B651
OBC

KALLISTA® Five-Year Limited Warranty

See website for detailed warranty information.

Available Colors/Finishes

Color tiles intended for reference only.

Color	Code	Description
	CP	Polished Chrome
	BAF	Brushed French Gold
	BN	Brushed Nickel
	BV	Brushed Bronze
	SN	Polished Nickel
	2MB	Brushed Moderne Brass

KALLISTA®

Script® by KALLISTA
Script Thermostatic Trim, Lever Handle
P25022-LV

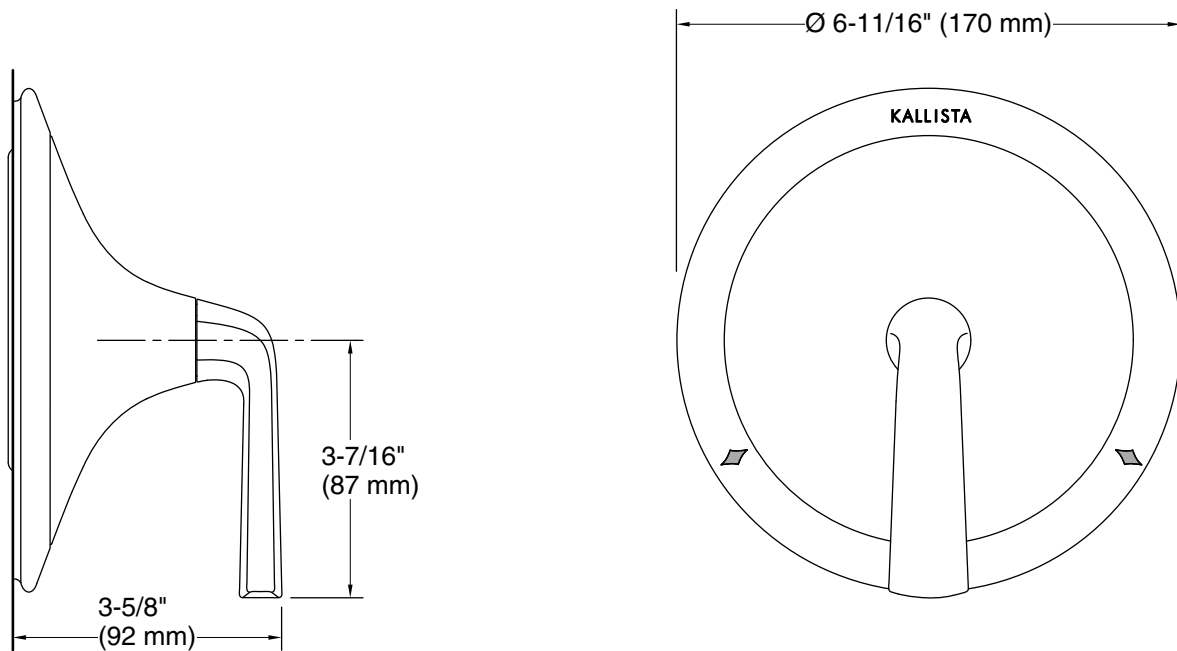

Technical Information

All product dimensions are nominal.

Notes

ADA, OBC, CSA B651 compliant when installed to the specific requirements of these regulations.