



**Juno SlimBasics™ JSBT Tapered Switchable White LED Surface Mount Disk Light**

4" and 6" Round Disk Lights for JBox Installation

Project:
Fixture Type:
Location:
Contact/Phone:

**JSBT 4IN/6IN Series**



**JSBT 4IN**



**JSBT 6IN**



**Dimensions**



**JSBT 4IN**

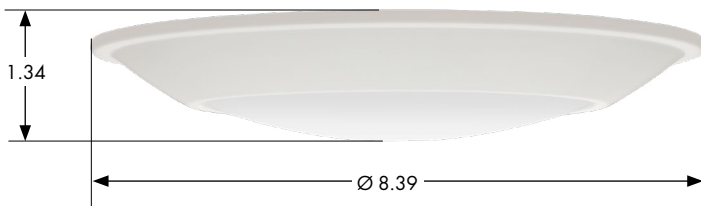

**JSBT 6IN**

**Product Features**

The SlimBasics JSBT Switchable White Tapered LED Disk Lights are designed to be paired with an inexpensive recessed junction box providing an economical alternative to recessed downlighting. Additionally, the JSBT offers the ultimate in flexibility for both new construction and renovations. An integrated 3CCT switch (3000/4000/5000K) allows the end user to fine-tune the feel of their space, while the two available sizes (4" and 6") insure you will have the right amount of light.

**Applications**

- Designed to be used across an entire space where traditional downlights have been used in the past
- Ideal for residential single and multi-family, as well as light commercial and hospitality spaces
- The wet location rating makes them perfect for use in bathrooms, soffits, and outdoor covered ceiling areas.
- Installs directly into industry standard junction boxes
- Suitable for use in closets, compliant when installed to NFPA® 70 NEC® Section 410.16 (A)(1) and (C)(1)

**Performance**

Delivered Lumens	JSBT 4IN = Up to 830L JSBT 6IN = Up to 1090L
LED Color Temperature	3000K/4000K/5000K
CRI	90+
Voltage	Dedicated 120V
Dimming	Phase Dimming down to 10%

**Specifications**

	Width	Depth	Lens Opening
JSBT 4IN	7.09	1.29	4.13
JSBT 6IN	8.39	1.34	5.62

All dimensions are in Inches



# Juno SlimBasics JSBT Tapered Switchable White LED Surface Mount Disk Light

4" and 6" Round Disk Lights for JBox Installation



JSBT 4IN

JSBT 6IN

## ORDERING INFORMATION

### Tapered LED Disk Light

Example: JSBT 4IN SWW2 90CRI WL MW M6

Series	Color Temperature	CRI	Wet Location	Color Finish
JSBT 4IN 4" Juno Tapered Disk Light	SWW2 3000K/4000K/5000K	90CRI 90CRI	WL Wet Location	MW Matte White
JSBT 6IN 6" Juno Tapered Disk Light				

ACCESSORIES	
JSBTRIM 4IN BL M6 <sup>1</sup>	Black 4" Trim
JSBTRIM 6IN BL M6 <sup>1</sup>	Black 6" Trim
JSBTRIM 4IN BZ M6 <sup>1</sup>	Bronze 4"
JSBTRIM 6IN BZ M6 <sup>1</sup>	Bronze 6"
JSBTADPTR 4IN CNDA M50	Canadian 4" JBOX Adapter

**Notes:**

<sup>1</sup> JSBTRIM only compatible with SWW2 non-PIR fixtures.

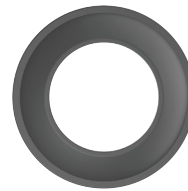

Black

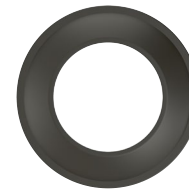

Bronze

## JBOX Compatibility

	3-1/2" Octagon Box Steel	4" Drawn Octagon 1-1/2" Deep Steel	3-1/2" Drawn Round Ceiling Pan Steel / Old Work	4" Round Plastic / New York	4" Drawn Round Ceiling Pan Steel	4" Round Plastic / New Work	4" Dia. Ceiling Box With Bar Plastic / New York
Exterior LXWXH	3.2" x 3.2" x 1.55"	3.54" x 3.54" x 1.55"	3.38" Rd. x 0.5" Dep.	4" Dia. x 2.3"	4" Dia. x 0.5" Dep.	4" Dia. x 2.375"	14.5" x 4.5" x 4"
Mounting Dimension	2.75"	3.5"	2.75"	2.75" / 3.5"	3.5"	2.75" / 3.5"	2.75" / 3.5"
Fixture	JSBT 4IN / JSBT 6IN	JSBT 6IN	JSBT 4IN / JSBT 6IN	JSBT 4IN / JSBT 6IN	JSBT 6IN	JSBT 4IN / JSBT 6IN	JSBT 4IN / JSBT 6IN

	4" Square Box	WiringPro 4" Square Box	Iberville 4" Octagonal Box
Exterior LXWXH	4" x 4" x 1.5"	4" x 4" x 1.5"	4" x 4" x 1.5"
Mounting Dimension	4"	4"	4"
Fixture	JSBT 4IN	JSBT 4IN	JSBT 4IN

### Canadian 4IN J-Box Bracket

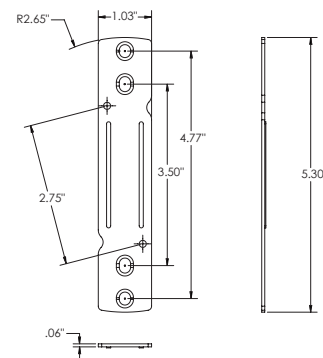



# Juno SlimBasics JSBT Tapered Switchable White LED Surface Mount Disk Light

4" and 6" Round Disk Lights for JBox Installation



JSBT 4IN

JSBT 6IN

## Install In 3 Simple Steps



## Dimmer Compatibility

Forward Phase Dimmers	Reverse Phase Dimmers	Acuity Brands Dimmers
Lutron Maestro® STCL-153		Acuity SensorSwitch® Forward phase paddle dimmer/WPD WH
Lutron RadioRa® RRD-10ND	Lutron Maestro ELV® MAELV-600	
Lutron Diva® DVCL-153P		
Lutron Vive® MRF2S-6ND		
Lutron Caseta® PD-6WCL		
Leviton SureSlide® IPMO6-1LZ		
Leviton Illumatech® IPLO6-1OZ		



## Juno SlimBasics JSBT Tapered Switchable White LED Surface Mount Disk Light

4" and 6" Round Disk Lights for JBox Installation



JSBT 4IN

JSBT 6IN

### Specifications

#### Construction

Low profile tapered aluminum trim frame with matte finish • Molded polycarbonate, UV stabilized diffuser dome lens conceals the LEDs from direct view and provides uniform lens luminance.

#### LED Light Engine

LED board mounted directly to aluminum housing designed to provide superior thermal management and ensure long life • Switchable white LED color temperature technology offers 3000K, 4000K, 5000K all in one disk light • 90 CRI minimum • Accommodates 120 volts AC at 60Hz • Dimmable with most standard magnetic low voltage and electronic low voltage dimmers.

#### Electrical Connections

Fixture provided with leads for direct wire connection in JBox.

#### Installation

##### Junction Box Mounting

The driverless JSBT installs directly into industry standard junction boxes that requires no separate mounting bracket for installation • Compatible boxes include 3-1/2" and 4" octagon junction boxes (1-1/2" minimum depth), round mud rings with 2-3/4" mounting centers, and 3" & 4" diameter non-metallic boxes • Provides fast installation of fully assembled fixture to JBox • Suitable for ceiling mount • Suitable for use in closets, compliant when installed to NFPA® 70 NEC® Section 410.16 (A)(1) and (C)(1).

#### Life

High performance, long functional life of 50,000 hrs (L70).

#### Labels

ETL listed for US and Canada • ENERGY STAR® Certified • Suitable for indoor wet locations • Certified to the high efficacy requirements of California T24 JA8-2019.

#### Testing

All reports are based on published industry procedures; field performance may differ from laboratory performance.

**Warranty** 5-year limited warranty. This is the only warranty provided and no other statements in this specification sheet create any warranty of any kind. All other express and implied warranties are disclaimed. Complete warranty terms located at: [www.acuitybrands.com/support/warranty/terms-and-conditions](http://www.acuitybrands.com/support/warranty/terms-and-conditions)

**Note:** Actual performance may differ as a result of end-user environment and application.

All values are design or typical values, measured under laboratory conditions at 25 °C.

Specifications subject to change without notice.



# Juno SlimBasics JSBT Tapered Switchable White LED Surface Mount Disk Light

4" and 6" Round Disk Lights for JBox Installation



JSBT 4IN

JSBT 6IN

## PHOTOMETRICS

Distribution Curve

Distribution Data

Output Data

Coefficient of Utilization

Illuminance Data at 30" Above Floor for a Single Luminaire

**JSBT 4IN SWW2 90CRI WL MW M6 - 3000K** Input Watts: 10.5, Delivered Lumens: 757, LPW: 72.1, S/MH: 1.18, Test No: 220100620SHA-001

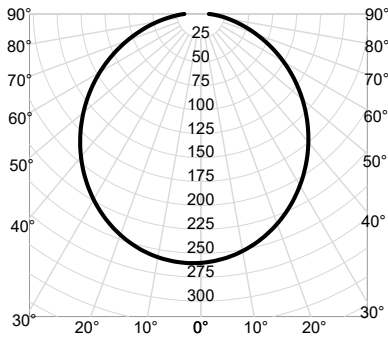

CP Summary	Zonal Lumen Summary				Coefficients of Utilization										Cone of Light			Luminance (cd/sq.m)
	0°	Zone	Lumens	% Fixture	pw	80%		20%		50%		Mounting Height	Initial FC Center Beam	Beam Diameter	Average Luminance			
						50%	30%	10%	50%	30%	10%					50%	30%	10%
0°	260	0° - 30°	200	26%	0	119	119	119	116	116	110	110	110	6.0	7.2	17.3	0° 29,096	
5°	257	0° - 40°	325	43%	1	103	98	94	100	96	92	95	92	8.0	4.1	23.0	45° 24,847	
15°	244	0° - 60°	570	75%	2	89	82	76	87	81	75	83	78	10.0	2.6	28.8	55° 23,282	
25°	221	0° - 90°	743	98%	3	78	70	63	76	69	62	73	66	12.0	1.8	34.5	65° 21,299	
35°	192	90° - 180°	14	2%	4	69	60	53	68	59	53	65	58	14.0	1.3	40.3	75° 19,106	
45°	157	0° - 180°	757	100%	5	62	53	46	61	52	46	58	51				85° 22,210	
55°	119				6	56	47	40	55	46	40	53	45					
65°	80				7	50	42	35	50	41	35	48	40					
75°	44				8	46	37	32	45	37	31	44	36					
85°	17				9	42	34	28	42	34	28	40	33					
90°	8				10	39	31	26	38	31	26	37	30					

Beam Angle: 110.0°  
Field Angle: 172.6°

**JSBT 4IN SWW2 90CRI WL MW M6 - 4000K** Input Watts: 10.5, Delivered Lumens: 804, LPW: 76.6, S/MH: 1.26, Test No: 220100620SHA-001

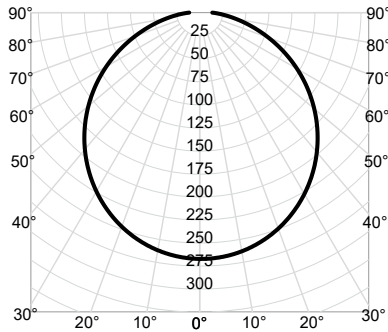

CP Summary	Zonal Lumen Summary				Coefficients of Utilization										Cone of Light			Luminance (cd/sq.m)
	0°	Zone	Lumens	% Fixture	pw	80%		20%		50%		Mounting Height	Initial FC Center Beam	Beam Diameter	Average Luminance			
						50%	30%	10%	50%	30%	10%					50%	30%	10%
0°	267	0° - 30°	207	26%	0	119	119	119	116	116	110	110	110	6.0	7.4	18.2	0° 29,908	
5°	266	0° - 40°	340	42%	1	102	98	94	100	96	92	95	92	8.0	4.2	24.3	45° 28,581	
15°	257	0° - 60°	603	75%	2	89	82	76	87	80	75	83	77	10.0	2.7	30.3	55° 27,820	
25°	239	0° - 90°	787	98%	3	78	70	63	76	68	62	73	66	12.0	1.9	36.4	65° 26,698	
35°	213	90° - 180°	17	2%	4	69	60	53	67	59	53	65	57	14.0	1.4	42.5	75° 25,488	
45°	181	0° - 180°	804	100%	5	62	52	46	60	52	45	58	50				85° 32,467	
55°	143				6	55	46	40	54	46	39	52	45					
65°	101				7	50	41	35	49	41	35	47	40					
75°	59				8	46	37	31	45	37	31	43	36					
85°	25				9	42	34	28	41	33	28	40	33					
90°	14				10	39	31	25	38	30	25	37	30					

Beam Angle: 113.2°  
Field Angle: 168.5°

**JSBT 4IN SWW2 90CRI WL MW M6 - 5000K** Input Watts: 10.6, Delivered Lumens: 789, LPW: 74.4, S/MH: 1.25, Test No: 220100620SHA-001

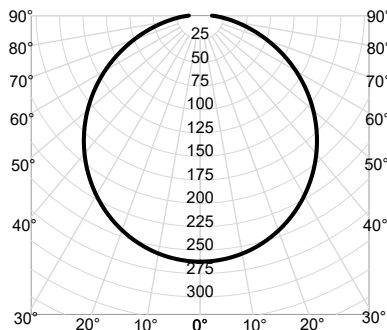

CP Summary	Zonal Lumen Summary				Coefficients of Utilization										Cone of Light			Luminance (cd/sq.m)
	0°	Zone	Lumens	% Fixture	pw	80%		20%		50%		Mounting Height	Initial FC Center Beam	Beam Diameter	Average Luminance			
						50%	30%	10%	50%	30%	10%					50%	30%	10%
0°	262	0° - 30°	204	26%	0	119	119	119	116	116	110	110	110	6.0	7.3	18.2	0° 29,355	
5°	261	0° - 40°	334	42%	1	102	98	94	100	96	92	95	92	8.0	4.1	24.3	45° 27,777	
15°	252	0° - 60°	592	75%	2	89	82	76	87	80	75	83	77	10.0	2.6	30.3	55° 26,929	
25°	234	0° - 90°	772	98%	3	78	70	63	76	68	62	73	66	12.0	1.8	36.4	65° 25,644	
35°	208	90° - 180°	17	2%	4	69	60	53	67	59	53	65	57	14.0	1.3	42.5	75° 24,188	
45°	176	0° - 180°	789	100%	5	61	52	46	60	52	45	58	50				85° 30,161	
55°	138				6	55	46	40	54	46	39	52	45					
65°	97				7	50	41	35	49	41	35	47	40					
75°	56				8	46	37	31	45	37	31	43	36					
85°	23				9	42	34	28	41	33	28	40	33					
90°	12				10	39	31	25	38	30	25	37	30					

Beam Angle: 113.2°  
Field Angle: 168.5°



# Juno SlimBasics JSBT Tapered Switchable White LED Surface Mount Disk Light

4" and 6" Round Disk Lights for JBox Installation



JSBT 4IN

JSBT 6IN

## PHOTOMETRICS

Distribution Curve

Distribution Data

Output Data

Coefficient of Utilization

Illuminance Data at 30" Above Floor for a Single Luminaire

**JSBT 6IN SWW2 90CRI WL MW M6 - 3000K** Input Watts: 14.5, Delivered Lumens: 1009, LPW: 69.6, S/MH: 1.25, Test No: 220100620SHA-002

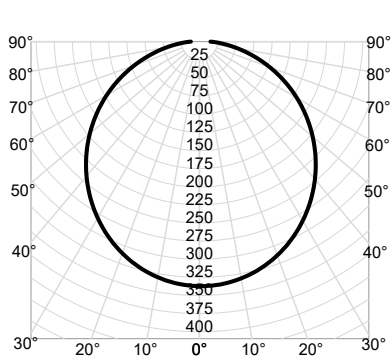

CP Zonal Lumen Summary				Coefficients of Utilization									Cone of Light			Luminance (cd/sq.m)		
0°	Zone	Lumens	% Fixture	pf	pc	80%			20%			Mounting Height	Initial FC Center Beam	Beam Diameter	Average Luminance			
						50%	30%	10%	50%	30%	10%					50%	30%	10%
0°	0° - 30°	261	26%	0	119	119	119	116	116	116	110	110	110	6.0	9.4	18.2	0°	22,817
5°	0° - 40°	426	42%	1	103	98	94	100	96	92	95	92	89	8.0	5.3	24.2	45°	21,680
15°	0° - 60°	756	75%	2	89	82	76	87	80	75	83	78	73	10.0	3.4	30.3	55°	21,237
25°	0° - 90°	992	98%	3	78	69	63	76	68	62	73	66	61	12.0	2.3	36.4	65°	20,726
35°	90° - 180°	17	2%	4	69	60	53	67	59	52	65	57	52	14.0	1.7	42.4	75°	20,263
45°	0° - 180°	1,009	100%	5	61	52	45	60	52	45	58	50	44				85°	24,764
55°	227			6	55	46	40	54	46	39	52	45	39					
65°	129			7	50	41	35	49	41	35	47	40	34					
75°	77			8	46	37	31	45	37	31	43	36	31					
85°	32			9	42	34	28	41	33	28	40	33	28					
90°	15			10	39	31	25	38	30	25	37	30	25					

Beam Angle: 113.1°  
Field Angle: 170.8°

**JSBT 6IN SWW2 90CRI WL - M6 4000K** Input Watts: 14.1, Delivered Lumens: 1078, LPW: 76.5, S/MH: 1.25, Test No: 220100620SHA-002

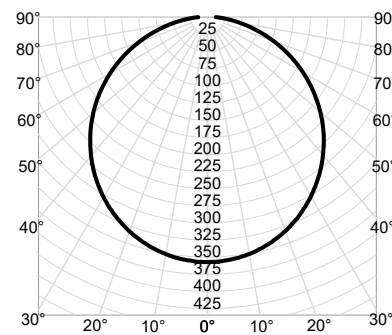

CP Zonal Lumen Summary				Coefficients of Utilization									Cone of Light			Luminance (cd/sq.m)		
0°	Zone	Lumens	% Fixture	pf	pc	80%			20%			Mounting Height	Initial FC Center Beam	Beam Diameter	Average Luminance			
						50%	30%	10%	50%	30%	10%					50%	30%	10%
0°	0° - 30°	277	26%	0	119	119	119	116	116	116	110	110	110	6.0	9.9	18.5	0°	24,172
5°	0° - 40°	455	42%	1	103	98	94	100	96	92	95	92	89	8.0	5.6	24.6	45°	22,920
15°	0° - 60°	810	75%	2	89	82	76	87	81	75	83	78	73	10.0	3.6	30.8	55°	22,215
25°	0° - 90°	1,055	98%	3	78	70	63	76	68	62	73	66	61	12.0	2.5	36.9	65°	21,148
35°	90° - 180°	23	2%	4	69	60	53	67	59	53	65	57	52	14.0	1.8	43.1	75°	19,423
45°	0° - 180°	1,078	100%	5	62	52	46	60	52	45	58	50	45				85°	20,698
55°	188			6	55	46	40	54	46	39	52	45	39					
65°	132			7	50	41	35	49	41	35	47	40	34					
75°	74			8	46	37	31	45	37	31	43	36	31					
85°	27			9	42	34	28	41	33	28	40	33	28					
90°	12			10	39	31	25	38	30	25	37	30	25					

Beam Angle: 114.0°  
Field Angle: 166.9°

**JSBT 6IN SWW2 90CRI WL MW M6 5000K** Input Watts: 14.3, Delivered Lumens: 1041, LPW: 72.8, S/MH: 1.25, Test No: 220100620SHA-002

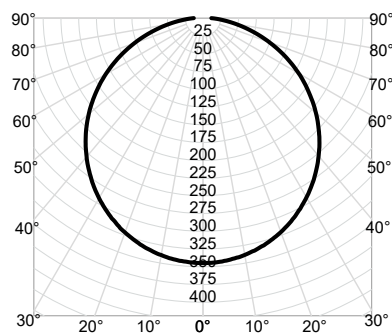

CP Zonal Lumen Summary				Coefficients of Utilization									Cone of Light			Luminance (cd/sq.m)		
0°	Zone	Lumens	% Fixture	pf	pc	80%			20%			Mounting Height	Initial FC Center Beam	Beam Diameter	Average Luminance			
						50%	30%	10%	50%	30%	10%					50%	30%	10%
0°	0° - 30°	268	26%	0	119	119	119	116	116	116	110	110	110	6.0	9.6	18.5	0°	23,334
5°	0° - 40°	439	42%	1	103	98	94	100	96	92	95	92	89	8.0	5.4	24.7	45°	22,127
15°	0° - 60°	782	75%	2	89	82	76	87	81	75	83	78	73	10.0	3.4	30.9	55°	21,452
25°	0° - 90°	1,018	98%	3	78	70	63	76	68	62	73	66	61	12.0	2.4	37.1	65°	20,487
35°	90° - 180°	22	2%	4	69	60	53	67	59	53	65	57	52	14.0	1.8	43.2	75°	18,778
45°	0° - 180°	1,041	100%	5	62	52	46	60	52	45	58	50	45				85°	20,018
55°	182			6	55	46	40	54	46	39	52	45	39					
65°	128			7	50	41	35	49	41	35	47	40	34					
75°	72			8	46	37	31	45	37	31	43	36	31					
85°	26			9	42	34	28	41	33	28	40	33	28					
90°	12			10	39	31	25	38	30	25	37	30	25					

Beam Angle: 114.1°  
Field Angle: 166.5°