

PART NO. A97014

5/8" M X F COMPRESSION TEE AA WATER HAMMER ARRESTER, LEAD FREE

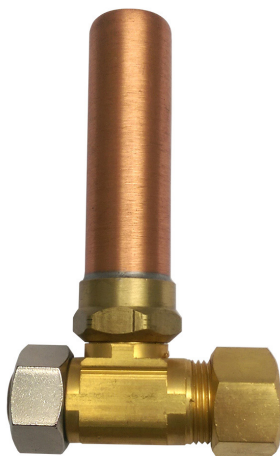

- Maximum working temp: 250°F
- Maximum working pressure: 300psi
- Poly Bagged
- UPC Listed
- Lead Free



FIXTURE	TYPE OF SUPPLY CONTROL	PUBLIC			PRIVATE		
		TOTAL	C.W.	H.W.	TOTAL	C.W.	H.W.
Water Closet	Flush Valve	10	10	--	6	6	--
Water Closet	Flush Tank	5	5	--	3	3	--
Pedestal Urinal	Flush Valve	10	10	--	--	--	--
Stall or Wall Unit	Flush Valve	5	5	--	--	--	--
Stall or Wall Unit	Flush Tank	3	3	--	--	--	1
Lavatory	Faucet	2	1-1/2	1-1/2	1	1	1-1/2
Bathtub	Faucet	4	2	3	2	1-1/2	1-1/2
Shower Head	Mixing Valve	4	2	3	2	1	2
Bathroom Group	Flush Valve Closet	--	--	--	8	8	3
Bathroom Group	Flush Tank Closet	--	--	--	6	6	3
Separate Shower	Mixing Valve	--	--	--	2	1	2
Service Sink	Faucet	3	3	3	--	--	--
Laundry Tubs (3)	Faucet	--	--	--	3	3	3
Combination Fixture	Faucet	--	--	--	3	3	3

Now apply the total fixture units to Table B to obtain your PDI size value.

PDI SIZE ARRESTER:	AA	A	B	C	D	E	F
FIXTURE UNITS:	1-5	1-11	12-32	33-60	61-113	114-154	155-330
THREAD SIZE:	1/2	1/2	3/4	3/4	1	1	1
CATALOG NUMBER:	ALL A97 SERIES						

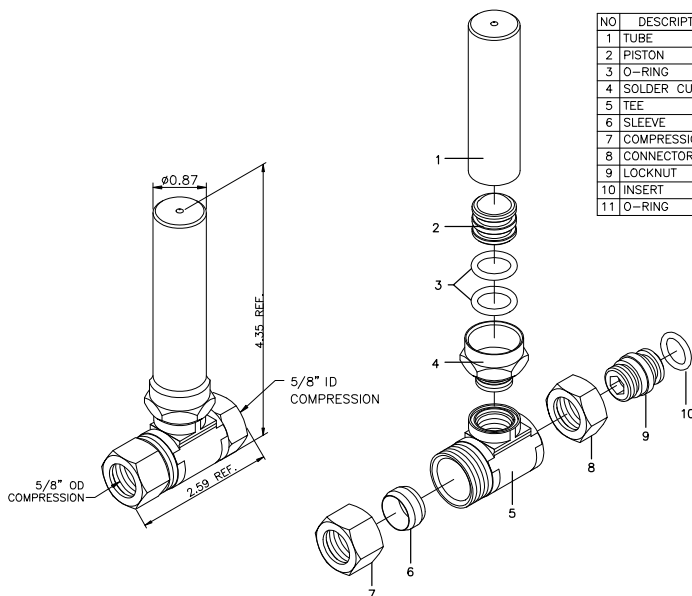

NO	DESCRIPTION	MATERIAL	FINISH	Q.TY
1	TUBE	COPPER	PLAIN	1
2	PISTON	PP+FIBER 30%	WHITE	1
3	O-RING	RUBBER (NBR)	BLACK	2
4	SOLDER CUP	BRASS C46400	PLAIN	1
5	TEE	BRASS C46400	PLAIN	1
6	SLEEVE	BRASS JIS C3604	PLAIN	1
7	COMPRESSION NUT	BRASS JIS C3604	PLAIN	1
8	CONNECTOR	BRASS C46400	NICKLE PLATED	1
9	LOCKNUT	BRASS JIS C3604	NICKLE PLATED	1
10	INSERT	BRASS C46400	PLAIN	1
11	O-RING	RUBBER (NBR)	BLACK	1