

SQUARE HEAD PLUG - YELLOW BRASS PIPE FITTING

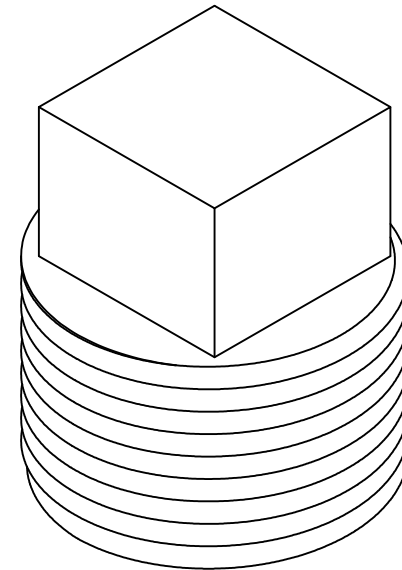
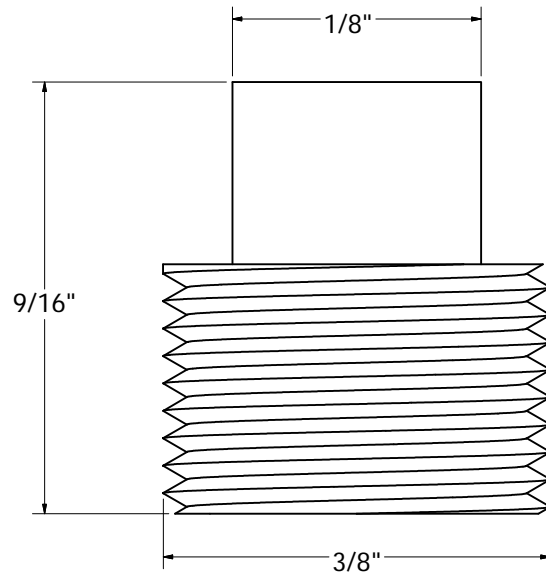
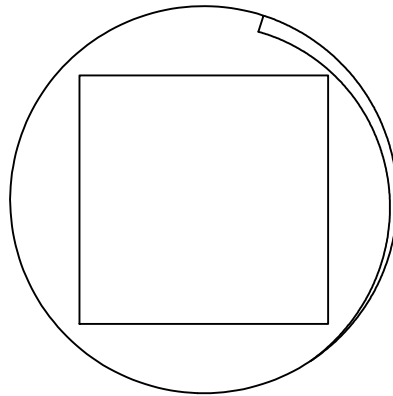

PHONE NUMBER
1-800-355-6637
FAX NUMBER
1-800-462-6991
SCALE DATE
1/20/15
SHEET
1 OF 1
DRAWN BY
ASHLEY KRALOVEC

PART NO.

P10092

IPT

1/8"

CTN/MSTR

1