

## USE AND CARE GUIDE

19.5-INCH PAPER ROPE CEILING FAN

# JY

JONATHAN Y

ITEM#: JYL9730

SIZE: 19.5"D x 7.5"H

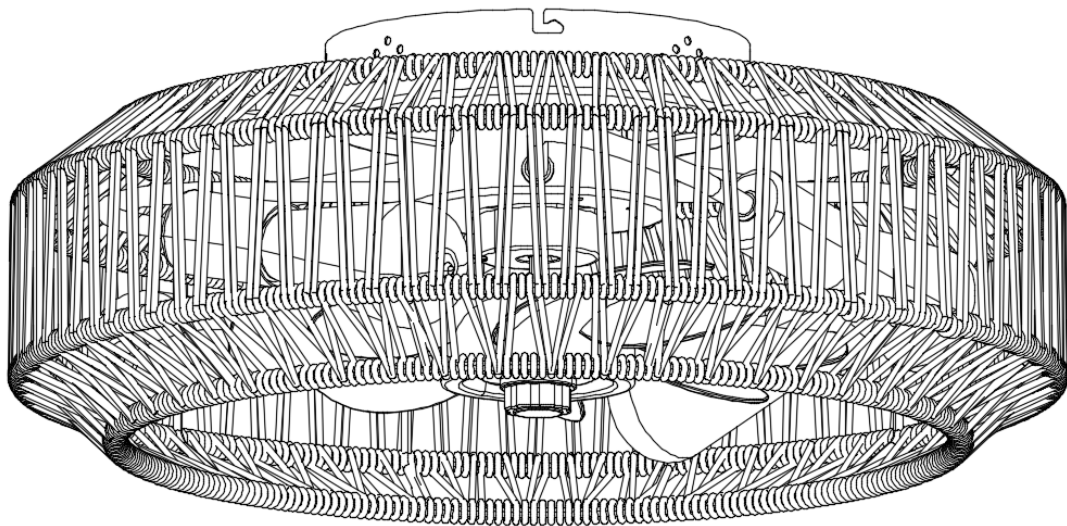

# Table of Contents

Table of Contents - - - - -	2	Assembly- - - - -	5
Safety Information - - - - -	2	Assembly - Standard CeilingMount ( continued )	6
Warranty - - - - -	3	Installation Instructions - - - - -	7-8
Pre-Installation - - - - -	3	Function instruction of emitter - - - - -	9
Pre-Installation(continued) - - - - -	4	Download APP - - - - -	10
Fan Parts Included - - - - -	5		

## Safety Information

### READ AND SAVE THESE INSTRUCTIONS

1. To reduce the risk of electric shock, ensure the electricity has been turned off at the circuit breaker or fuse box before you begin.
2. All wiring must be in accordance with the National Electrical Code ANSI/NFPA 70-1999 and local electrical codes. Electrical installation should be performed by a qualified licensed electrician.
3. The outlet box and support structure must be securely mounted and capable of reliably supporting 35 lbs (15.9 kg). Use only UL Listed outlet boxes marked "Acceptable for Fan Support of 35 lbs (15.9 kg) or less."
4. CAUTION: The fan must be mounted with a minimum of 7 ft. (2.1 m) clearance from the trailing edge of the blades to the floor.
5. Do not operate the reversing switch while the fan blades are in motion. You must turn the fan off and stop the blades before you reverse the blade direction.
6. Do not place objects in the path of the blades.
7. To avoid personal injury or damage to the fan and other items, use caution when working around or cleaning the fan.
8. Electrical diagrams are for reference only. Light kits that are not packed with the fan must be UL-listed and marked suitable for use with the model fan you are installing. Switches must be UL General Use Switches. Refer to the instructions packaged with the light kits and switches for proper assembly.
9. After making electrical connections, spliced conductors should be turned upward and pushed carefully up into the outlet box. The wires should be spread apart with the grounded conductor and the equipment-grounding conductor on one side of the outlet box.
10. All setscrews must be checked and retightened where necessary before installation.



**WARNING:** To reduce the risk of personal injury, do not bend the blade brackets (also referred to as flanges) during assembly or after installation. Do not insert objects in the path of the blades.



**WARNING:** To reduce the risk of fire or electric shock, this fan must be installed with an isolating wall switch.



**WARNING:** To avoid possible electrical shock, turn the electricity off at the main fuse box before wiring. If you feel you do not have enough electrical wiring knowledge or experience, contact a licensed electrician.



**WARNING:** Electrical diagrams are for reference only. Optional use of any light kit shall be UL-listed and marked suitable for use with this fan.



**WARNING:** To reduce the risk of fire, electric shock, or personal injury, mount to outlet box marked "Acceptable for fan support of 35 lbs. (15.9 kg) or less," and use the screws provided with the outlet box.



**WARNING:** To reduce the risk of electrical shock or fire, do not use this fan with any solid-state fan speed control device. It will permanently damage the electronic circuitry.



**CAUTION:** To reduce the risk of personal injury, use only the screws provided with the outlet box.

# Warranty

The supplier warrants the fan motor to be free from defects in workmanship and material present at time of shipment from the factory for a lifetime after the date of purchase by the original purchaser. The supplier also warrants that all other fan parts, excluding any glass or acrylic blades, to be free from defects in workmanship and material at the time of shipment from the factory for a period of one year after the date of purchase by the original purchaser. We agree to correct such defects without charge or at our option replace with a comparable or superior model if the product is returned. To obtain warranty service, you must present a copy of the receipt as proof of purchase. All costs of removing and reinstalling the product are your responsibility. Damage to any part such as by accident or misuse or improper installation or by affixing any accessories, is not covered by this warranty. Because of varying climatic conditions this warranty does not cover any changes in brass finish, including rusting, pitting, corroding, tarnishing, or peeling. Brass finishes of this type give their longest useful life when protected from varying weather conditions. A certain amount of "wobble" is normal and should not be considered a defect. Servicing performed by unauthorized persons shall render the warranty invalid. There is no other express warranty. JONATHAN Y hereby disclaims any and all warranties, including but not limited to those of merchantability and fitness for a particular purpose to the extent permitted by law. The duration of any implied warranty which cannot be disclaimed is limited to the time period as specified in the express warranty. Some states do not allow a limitation on how long an implied warranty lasts, so the above limitation may not apply to you. The retailer shall not be liable for incidental, consequential, or special damages arising out of or in connection with product use or performance except as may otherwise be accorded by law. Some states do not allow the exclusion of incidental or consequential damages, so the above exclusion or imitation may not apply to you, This warranty gives specific legal rights, and you may also have other rights which vary from state to state. This warranty supersedes all prior warranties. Shipping costs for any return of product as part of a claim on the warranty must be paid by the customer.

## PREPARATION

Before beginning assembly of product, make sure all parts are present. Compare parts with package contents list and hardware contents list. If any part is missing or damaged, do not attempt to assemble the product. If there are any questions relating to defects, missing parts, assembly issues, replacements, or device connectivity issues, please send a detailed email to [cs@jonathany.com](mailto:cs@jonathany.com)

## Pre-Installation

### SPECIFICATION

Size	Speed	Volts	Amps	Watts	RPM	CFM	Net Weight	Gross Weight	Cube Feet
19.5in	1	120	0.05	3.0	550	275	5.94lb 2.7kg	9.9lb 4.5kg	2.5cu.ft
	2		0.08	5.2	648	282			
	3		0.09	6.4	749	294			
	4		0.13	8.5	843	331			
	5		0.17	11.2	941	352			
	6		0.2	16.0	1035	373			

The above data are for reference only, Actually the motor speed of each ceiling fan is a little different. Any products, Subject to actual products as standard.



**NOTE:** These are approximate measures. They do not include the amps and wattage used by the light kit.

Specifications & measurements shown are subject to + 5% variations.

# Pre-Installation(continued)

## TOOLS REQUIRED

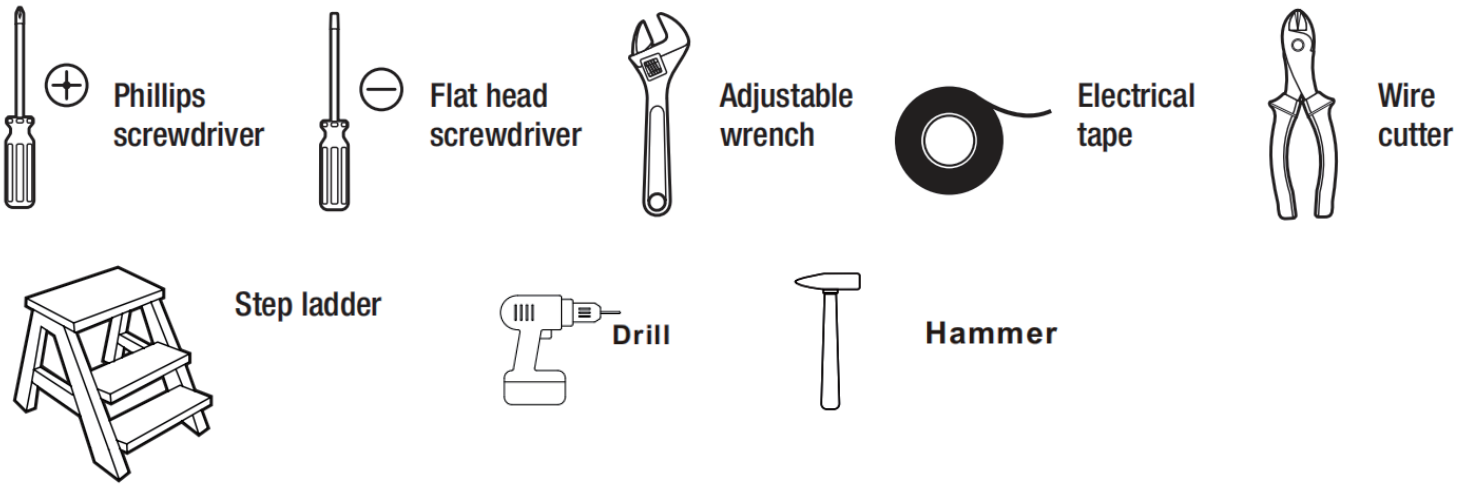

## HARDWARE INCLUDED

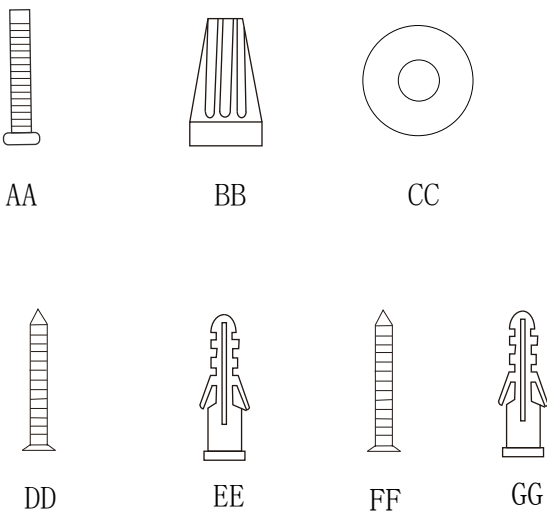

 **NOTE:Hardware not shown to actual size.**

AA	Mounting screw	2
BB	Wire nuts	3
CC	Washer	2
DD	Tapping screws	4
EE	Plastic anchor(Big)	4
FF	Remote control holder screw	2
GG	Plastic anchor(Small)	2

# Fan Parts Included

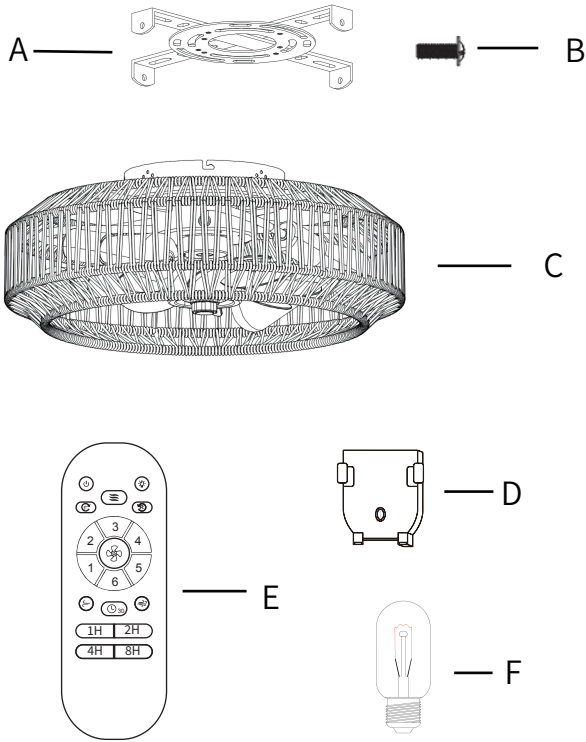

 NOTE: Hardware not shown to actual size.

A	Hanging Board	1
B	Hanging Board Screw (preassembled)	4
C	Fixture body	1
D	Remote control holder	1
E	Transmitter	1
F	lamp bulb	4

## Assembly

### MOUNTING OPTIONS



**WARNING:** To reduce the risk of fire, electric shock, or personal injury, mount to outlet box marked “acceptable for fan support of 15.9 kg (35 lbs) or less” using the screws provided with the outlet box. An outlet box commonly used for the support of lighting fixtures may not be acceptable for fan support and may need to be replaced. If in doubt, consult a qualified electrician.

If your ceiling fan does not have an existing UL-listed mounting box, then install one using the following instructions:

- Disconnect the power by removing the fuses or turning off the circuit breakers.
- Secure the outlet box directly to the building structure. Use the appropriate fasteners and materials. The outlet box and its bracing must be able to fully support the weight of the moving fan (at least 15.9 kg). Do not use a plastic outlet box.

The illustrations on the right show two different ways to mount the outlet box.

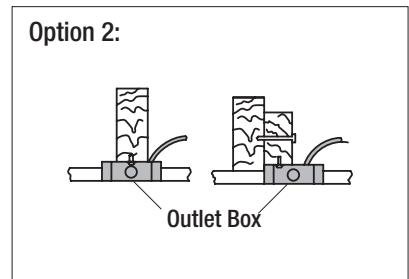
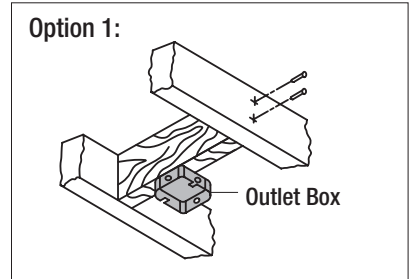

To hang your fan where there is an existing fixture but no ceiling joist, you may need an installation hanger bar as shown above

## Assembly - Standard Ceiling Mount (continued)

### 1. Take out the hanging board

Remove the two hanging board screws(B) from the circular hole of the canopy, and keep them.

Remove the hanging board(A) from the fixture body(C).

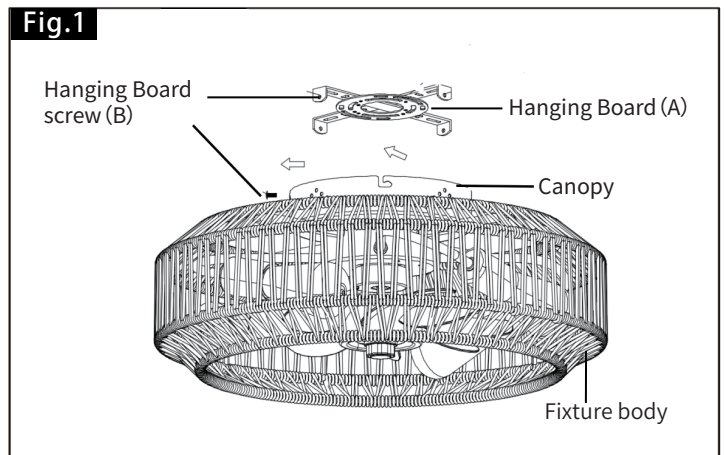

### 2. Installing the hanging board

Attach the hanging board (A) to the outlet box(not included) with the two mounting screws (AA) and washer(CC).

Secure the hanging board (A) to the ceilings with the tapping screws (DD).

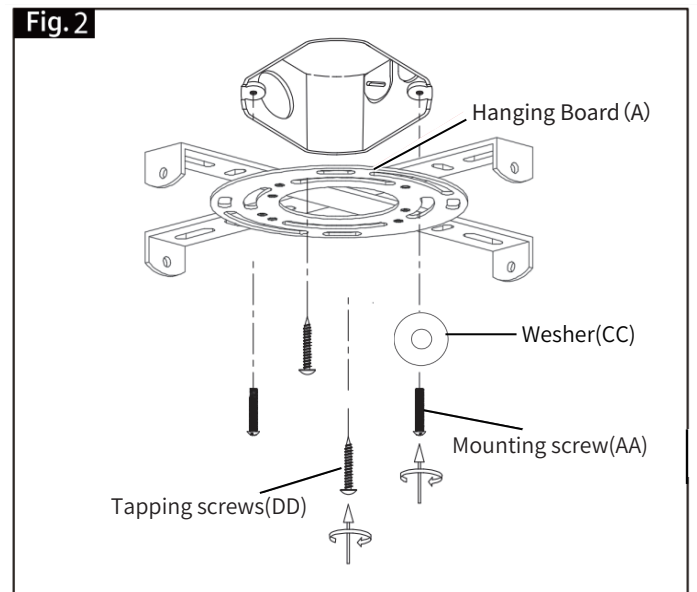

# Installation Instructions

## 3. Making the electrical connections



**WARNING :** Make sure power is off before attempting installation.



**NOTE:** Always use wire nuts (BB) to connect wires and push all excess wires and connections back into the outlet box.

### • Wiring

TIPS: To facilitate wiring, please use a safety rope to hang the ceiling fan. Connect the "Neutral wire" (white wire) from the ceiling to the white wire of ceiling fan.

Connect the "Live wire" (black wire) from the ceiling to the black wire of ceiling fan.

Connect the "Ground wire" (green or yellow/green or bare) from the ceiling to the green wires from the hanging board and ceiling fan.

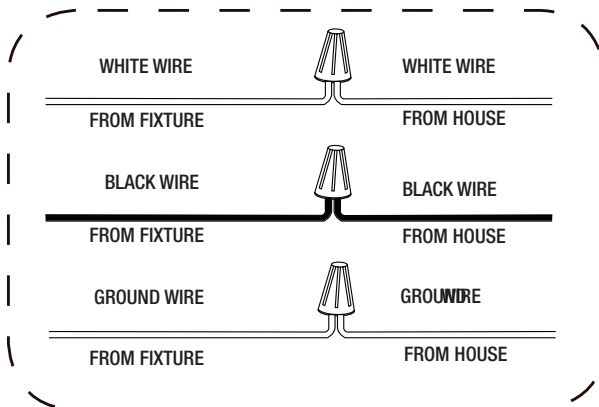

## 4. installing the ceiling fan assembly

Rotary the canopy to make sure four canopy holes align to the four holes on the Hanging Board(A). Use four Hanging Board screw(B) to secure the canopy onto the Hang Board.

**Fig. 3**

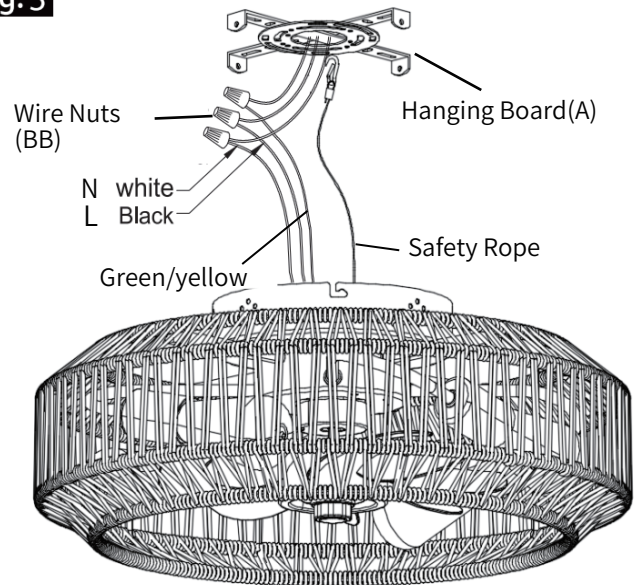

**Fig. 4**

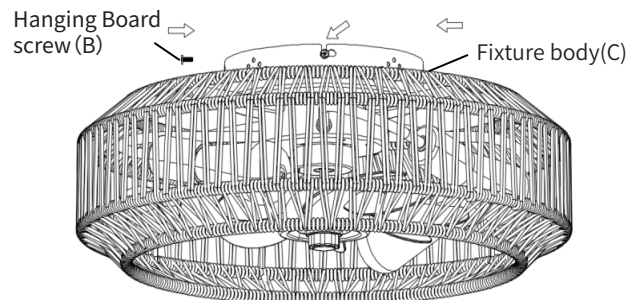

## 5.Attaching the lamp bulbs



**CAUTION:** Do not over tighten the hex nut, overtightening the hex nut may cause the shatter resistant bowl to break.

- ① Take out four lamp bulbs(F) from the packaging box and install them on the lamp lamp holders and tighten the lamp bulbs.
- ② Please use type "A" bulb MAX 40-watt or led bulb MAX 9-watt, there is led 4-watt bulb in the box.

Fig.5

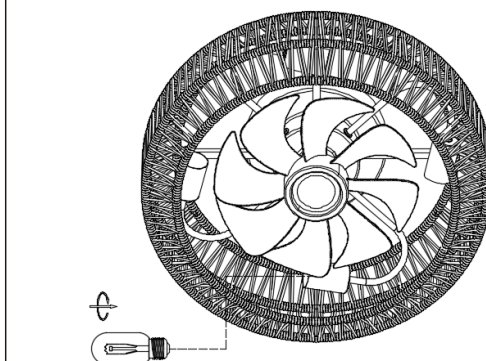

### ● Installing Wall Plate

Attach wall plate using the two screws and two plastic anchors provided in remote control accessory pack.

Fig.6

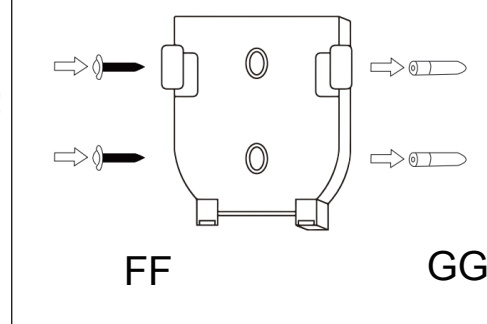





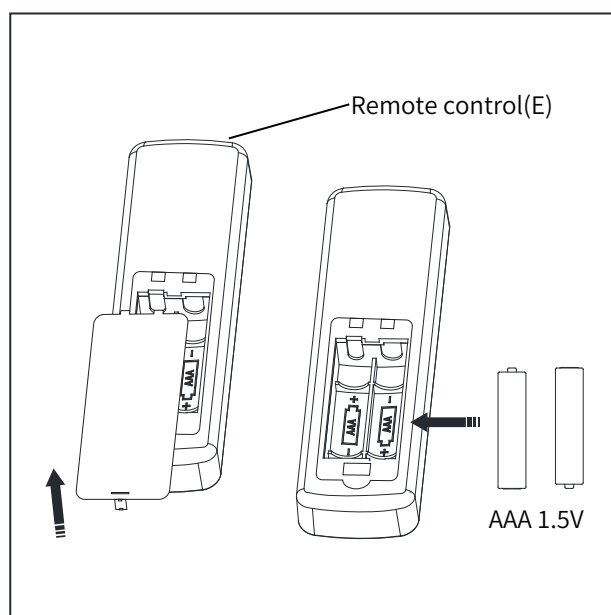



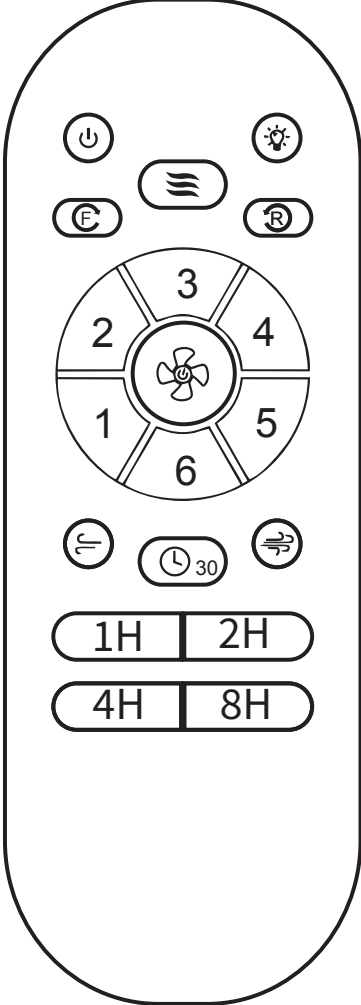

## Preparing the remote contro

- ① Remove the remote control(E) battery cover by pressing firmly on the arrow and sliding the cover off.
- ② Install two 1.5V AAA batteries(do not included).
- ③ Replace the battery cover on the remote control(E).





# FUNCTION INSTRUCTION OF EMITTER

		Light&Fanall OFF
	1-6	Fan Speed
		light ON/OFF
		Fan Off
		Forward
		Reverse
		Natural Wind
		Fan speed reduced
		Fan speed increase
		Timed 30 minutes off
	1H	Fan stop & light off after 1 hour.
	2H	Fan stop & light off after 2 hours.
	4H	Fan stop & light off after 4 hours.
	8H	Fan stop & light off after 8 hours.

To operate the fan , please install 2 AAA batteries ( do not included ) in the handheld remote transmitter . If not used for extended periods of time , remove the batteries to prevent damage to the transmitter. Store the remote away from excessive temperatures and humidity.

Pairing method : ( single / multiple fans )

Turn on the power while holding down the "1H + 4H" button , 3-5 seconds , release the "1H + 4H" button . Press any button , the fan can work normally , the code is completed. If not , please turn off the power once a minute in a repeat operation . Clear Code : power-on Long Press "Fan off " 8 seconds , the controller has a prompt sound.

Tips: The remote control has completed the learning pairing procedure before leaving the factory . After installation , it can be used directly . If you want to add or replace a new remote control , you need to pair it again.

## Download APP

- 1.Download and install the "JONATHAN Y" Mobile app.
  - 2.Open applications and accept privacy policies.
  - 3.Create a new account.
  - 4.Select the "+" button in the upper right corner of the screen.
  - 5.Select add device and activate your location.
  - 6.Open Bluetooth add device to discover device connection addition.
  - 7.Alternatively , under " Manually add " , select "Home appliances" and choose " Fan ( Wi-fi)".
  - 8.Connect to the 2.4 ghz Wi-Fi network, and then continue to select "Next".
  - 9.Continue with the steps indicated by the application.
  - 10.After registering, the device will return to the home page where you can find the connected fan.
- #WiFi reset operation:power-on, long press "Light" button ,hear buzzer sound 3, reset successfully.

## SPECIFICATIONS

Applications	Light/Fan
Operating Voltage	110V/120V Depending on model
Max load Power	<300W Ceiling Fan / <200W LED Light
Standby Power Consumption	<0.5 W
Working Temperature	-20°C~80°C
Control Method	Remote control & Mobile App Control
Wiring Method	Live Wire & Neutral Wire

# Intelligent function

In addition to the included control , you can operate your fan with the JONATHAN Y app.

## Upgradeable with Smart Features

Scan the code to the right with your phone to find out how you can enable smart features through the JONATHAN Y app and integrate with your smart home ecosystem.

1. To use the JONATHAN Y app , download it from the App Store or Google Play.
2. Open the app to create your account . You can also log in using your Facebook or Google account.
- 3.To set up a Wi-Fi connection you will need the SSID and Wi-Fi password for the network you wish to connect to.
4. You will receive a prompt to name your fan device and upload an optional picture of it if you choose.



# Care and Cleaning



**WARNING:** Make sure the power is off before cleaning your fan.

- Because of the fan's natural movement, some connections may become loose. Check the support connections, brackets, and blade attachments twice a year. Make sure they are secure. It is not necessary to remove the fan from the ceiling.
- Clean your fan periodically to help maintain its new appearance over the years. Do not use water when cleaning, as this could damage the motor or the wood, or possibly cause an electrical shock. Use only a soft brush or lint-free cloth to avoid scratching the finish. The plating is sealed with a lacquer to minimize discoloration or tarnishing.
- You can apply a light coat of furniture polish to the wood for additional protection and enhanced beauty. Cover small scratches with a light application of shoe polish.
- You do not need to oil your fan. The motor has permanently-lubricated sealed ball bearings.

# Troubleshooting

Problem	Solution
The fan will not start.	<ul style="list-style-type: none"> <li><input type="checkbox"/> Check the main and branch circuit fuses or breakers.</li> <li><input type="checkbox"/> Check the line wire connections to the fan and switch wire connections in the switch housing.</li> </ul>
The fan will not start.	<ul style="list-style-type: none"> <li><input type="checkbox"/> Ensure all motor housing screws are snug.</li> <li><input type="checkbox"/> Ensure the screws that attach the fan blade bracket to the motor hub are tight.</li> <li><input type="checkbox"/> Ensure the wire nut connections are not rattling against each other or the interior wall of the switch housing.</li> <li><input type="checkbox"/> Allow a 24-hour "breaking in" period. Most noises associated with a new fan disappear during this time.</li> <li><input type="checkbox"/> If you are using the Ceiling Fan light kit, ensure the screws securing the glassware are tight. Check that the light bulbs are also secure.</li> <li><input type="checkbox"/> Ensure the canopy is a short distance from the ceiling. It should not touch the ceiling.</li> <li><input type="checkbox"/> Ensure your outlet box is secure and rubber isolator pads were used between the mounting plate and outlet box.</li> </ul>
The fan wobbles.	<ul style="list-style-type: none"> <li><input type="checkbox"/> Check that all blade and blade arm screws are secure.</li> <li><input type="checkbox"/> Most fan wobble problems are caused when blade levels are unequal. Check this level by selecting a point on the ceiling above the tip of one of the blades. Measure from a point on the center of each blade to the point on the ceiling. Measure this distance. Rotate the fan until the next blade is positioned for measurement. Repeat for each blade. Any measurement deviation should be within 1/8 in. Run the fan for ten minutes. If the fan continues to wobble please refer the page 10</li> </ul>

Remote control fan

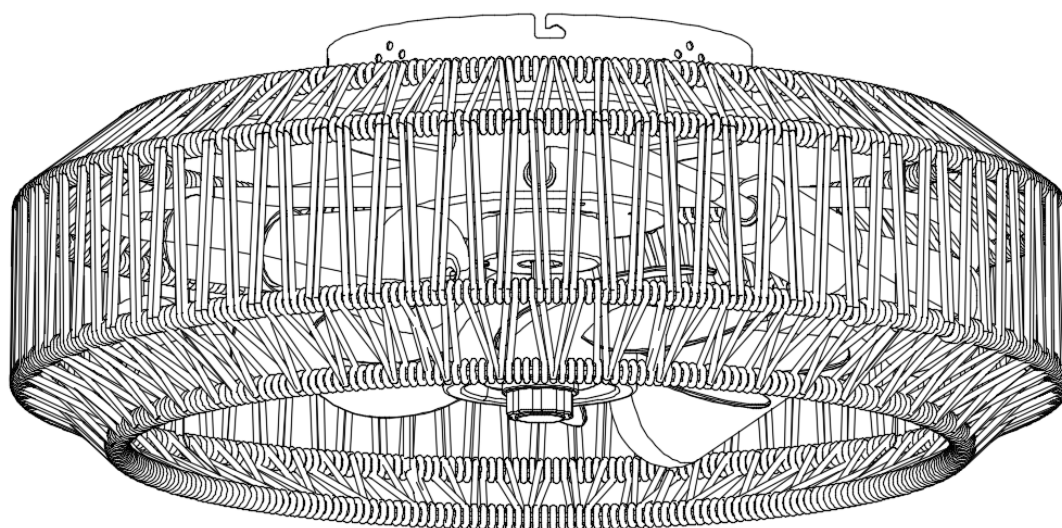

## USE AND CARE GUIDE

19.5-INCH PAPER ROPE CEILING FAN