

WARNING

WE RECOMMEND INSTALLATION OF THIS LIGHTING FIXTURE BE DONE BY A LICENSED ELECTRICIAN.
WARNING *** SWITCH OFF THE MAIN ELECTRICAL SUPPLY FROM THE MAIN FUSE BOX/CIRCUIT BREAKER BEFORE INSTALLATION.
INSPECT ITEM CAREFULLY BEFORE ATTEMPTING TO INSTALL. IF THERE IS ANY DAMAGE OR OBVIOUS DEFECT, DO NOT INSTALL. ITEM MAY NOT BE RETURNED ONCE IT HAS BEEN INSTALLED.















CARE AND MAINTENANCE

To clean the outside of the fixture, use a dry or slightly dampened clean cloth (use clean water, never a solvent) to wipe the surface of the fixture.
To clean the inside of the fixture, first disconnect power to the fixture by turning off the circuit breaker or by removing the fuse at the fuse box. Next, use a dry or slightly dampened clean cloth (use clean water, never a solvent) to wipe the interior surface of the fixture.
Do not use any cleaners with chemical, solvents or harsh abrasives. Use only a dry soft cloth to dust or wipe carefully.

NOTICE & IMPORTANT SAFETY INSTRUCTIONS

- * Please make sure that you have all parts indicated before you begin assembly of this item
- * This item should be assembled on a soft surface to prevent scratching the finish during assembly
- * To reduce the risk of fire, electrical shock or injury to persons or property, please follow the guideline below for safe use and installation
- *The external flexible cable or cord of this lamp cannot be replaced
- *If the cord is damaged, the lamp shall be destroyed

Part List and Hardware List

PIECE	DESCRIPTION	PICTURE	QUANTITY	PIECE	DESCRIPTION	PICTURE	QUANTITY
A	wire connector		3X	H	mounting screw		2X
B	Wall plug		2X	I	lamp body		1X
C	mounting bracket		1X	J	Wire locking device		1X
D	ground screw		1X	K	M3 hex screw		2X
E	tapping screw		2X	L	M3 allen wrench		1X
F	metal plate		2X	M	M4 allen wrench		1X
G	machine screw		2X	N	M4 hex screw		4X

JY

JONATHAN Y

Model#: JYL7140

Product Dimensions: 25"Lx25"WX13-72"H

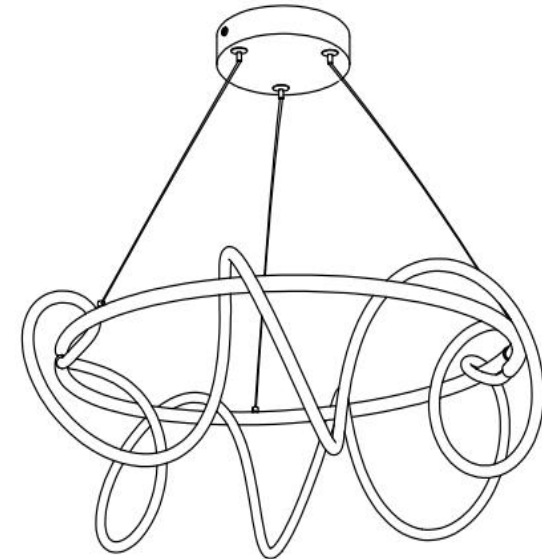

PREPARATION

Before beginning assembly of product, make sure all parts are present. Compare parts with package contents list and hardware contents list. If any part is missing or damaged, do not attempt to assemble the product.

Estimated Assembly Time: 10 minutes.

If there are any questions relating to defects, missing parts, assembly issues, replacements, or device connectivity issues, please send a detailed email to cs@jonathany.com

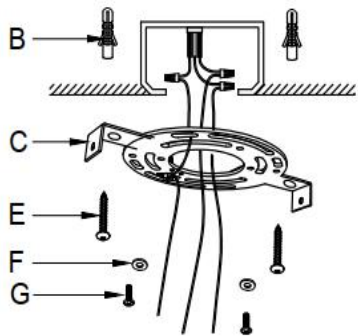

Step 1: Punch the hole and install the Wall plug (B) to the ceiling. Fix the mounting bracket (C) to the outlet box with tapping screw (E) and mounting screw (G).

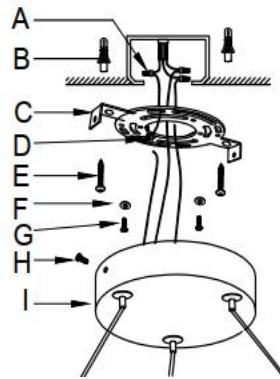

Step 3: Carefully remove packaging from fixture, adjust wire length to desired mounting height, fix the lamp body (I) to mounting bracket (C) using machine screw (H).

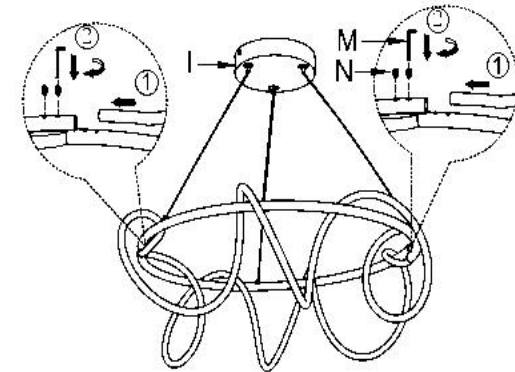

Step 5: Hose wrap around the lamp body (I) and secure it with allen wrench (M) and hex screw (N).
Step 6: . Adjust hose wrap to make it beautiful.

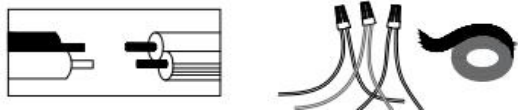

Step 2: Wire connection (A) Connect fixture neutral wire (ribbed) to the outlet box neutral wire (usually white) using a wire nut. Connect fixture hot wire (smooth with markings) to the outlet box hot wire (usually black) using a wire nut. CAUTION: Do not reverse the hot and neutral connections.

Grounding Instructions:

Wrap ground wire from outlet box around green ground screw (D) on mounting bracket, no less than 2" from wire end. Tighten ground screw. If fixture is supplied with a ground wire, connect to outlet ground wire with a wire connector.

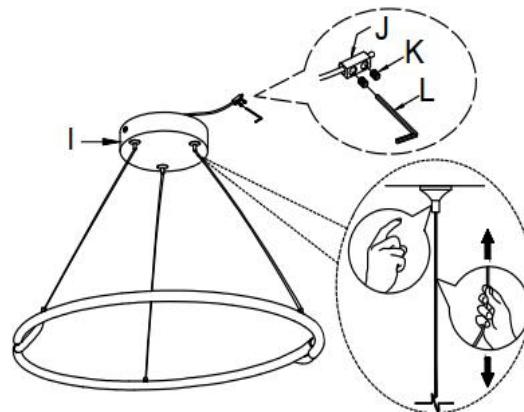

Step 4: Press the expansion piece and adjust the height of the lamp body (I). If the expansion piece fails, Move wire locking device (J) to the desired position and lock it with hex screw (K) and allen wrench (L).

ENJOY YOUR LAMP

Compatible Dimmer Model:

Brand	Model No.
TP-LINK	HS220
LUTRON	MACL-153M
LUTRON	DVCL-153P
LUTRON	PD-6WCL
LUTRON	P-PKG1W-WH-R
LEVITON	R11-DSL06-1TW
LEVITON	R00-RNL06-0TW
LEVITON	R68-06674-POT
LEVITON	R02-DW6HD-2RW