

JONATHAN Y

USER GUIDE - LED LIGHTED MIRROR



IF IN DOUBT ABOUT FITTING THIS PRODUCT, PLEASE CONSULT A QUALIFIED ELECTRICIAN

IMPORTANT

PLEASE READ THE INSTRUCTIONS BEFORE SET UP AND INSTALLATION

COMPONENT PARTS AND FITTINGS

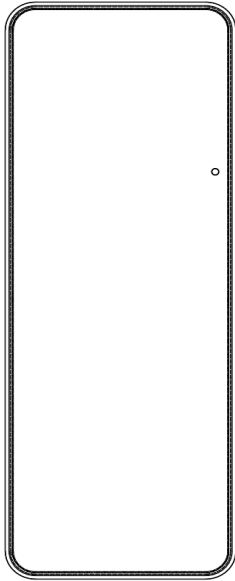

Mirror

Suggested Tools:



Screw & Wall plug x 4
(Included in pack)



Screw driver

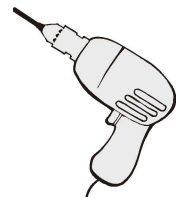

Drill

Safety Warning

Safety:

- We suggest you spend a short time reading the instruction leaflet
- Carefully check that you have all the parts before beginning assembly.
- Keep small parts and fittings out of children's reach and keep children well away from construction area, as the unassembled product contains small parts, which could present a choking hazard.
- We suggest you retain these instructions for future reference.
- This appliance can be used by adults ONLY.
- If the supply cord is damaged, it must be replaced by the manufacturer, its service agent or similarly qualified persons in order to avoid a hazard.

Caution:

- In order to avoid overheating, do not cover the mirror.
- Switch off the mains supply and remove the appropriate fuse or switch off the appropriate circuit breaker before commencing installation
- Make sure that there is no danger that the cord or extension cord is inadvertently pulled or cause anyone to trip when in use.

Assembly/User Instruction

Please read all instructions carefully. Before you proceed to install, make sure that the power supply is turned off and remains off until installation is complete. Please note that each part has been assigned a number and proceed in a numerical order.

If there are any questions relating to defects, missing parts, assembly issues, replacements, or device connectivity issues, please send a detailed email to cs@jonathany.com

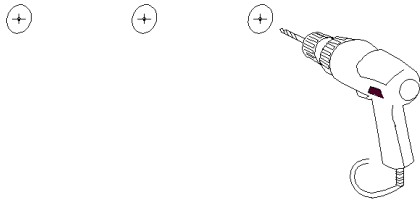

STEP1. Mark the position of the hanging screw.

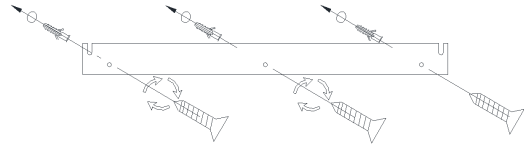

STEP2. Fix the screw.

STEP3. Connect to the main supply

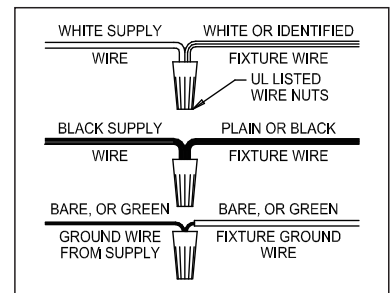
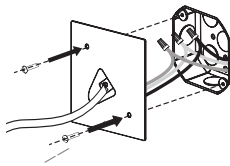
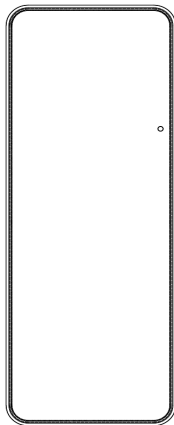

STEP4. Hang up the Mirror on the wall

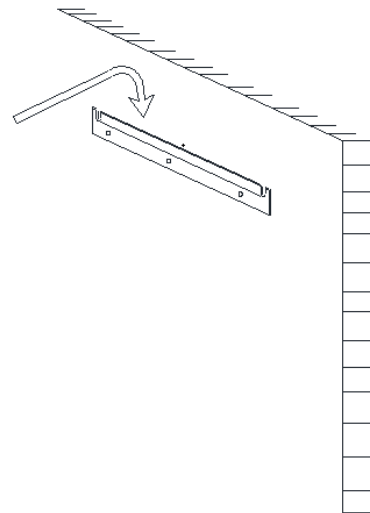
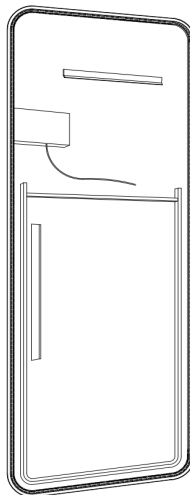
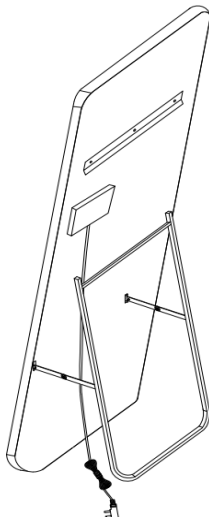

Installation Dimensions:

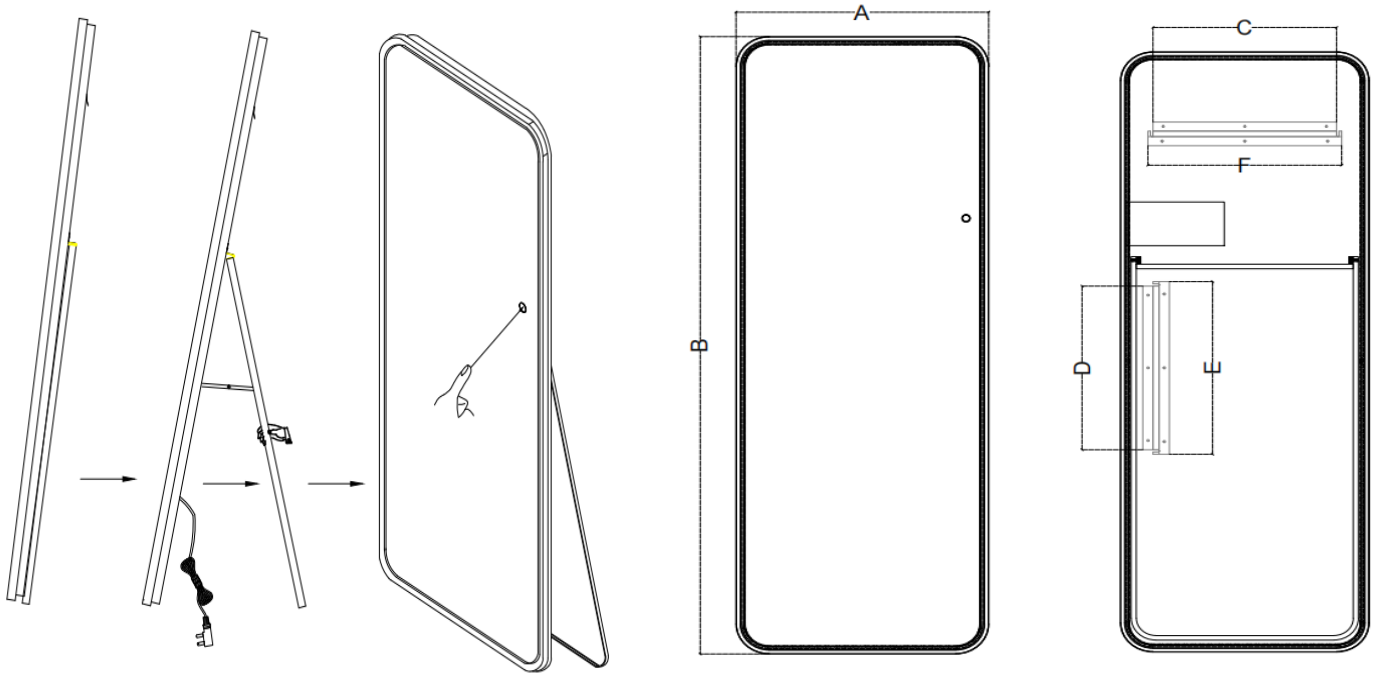

Can adjust three kinds of color temperature.
Press once to change color temp. and on-off. Press
and hold switch for dimming the lumens.

After turning on the light mirror, the anti-fog and
LED lights will automatically
power off after an hour.

MODEL	A (inch)	B (inch)	C (inch)	D (inch)	E (inch)	F (inch)	Color Temperature	LED Length (inch)	Drive Wattage
MIR105A-2465	24	65	17.7	17.7	18.7	18.7	4200K/6400K/3000K	173.2	72W
MIR105B-2465	24	65	17.7	17.7	18.7	18.7	4200K/6400K/3000K	173.2	72W