

WARNING

INSPECT ITEM CAREFULLY BEFORE ATTEMPTING TO INSTALL. IF THERE IS ANY DAMAGE OR OBVIOUS DEFECT, DO NOT INSTALL. ITEM MAY NOT BE RETURNED ONCE IT HAS BEEN INSTALLED.

CARE AND MAINTENANCE









Unplug lamps before using any cleaning solutions. Dust shades with a feather duster or with an appropriate vacuum-brush attachment. Wipe with a soft, dry cloth and clean lamp bases with the methods appropriate to the material. Avoid the use of chemicals and household cleaners as they may damage the finish.

NOTICE & IMPORTANT SAFETY INSTRUCTIONS

- * Please make sure that you have all parts indicated before you begin assembly of this item
 - * This item should be assembled on a soft surface to prevent scratching the finish during assembly
 - * To reduce the risk of fire, electrical shock or injury to persons or property, please follow the guideline below for safe use and installation
 - * The external flexible cable or cord of this lamp cannot be replaced
- If the cord is damaged, the lamp shall be destroyed

**This portable lamp has two polarized plug (one blade is wider than the other) as a safety feature to reduce the risk of electric shock. this plug will fit in a polarized outlet only one way. if the plug does not fit fully in the outlet, reverse the plug, if it still does not fit, contact a qualified electrician. Never use with an extension cord unless the plug can be fully inserted. do not attempt to disregard this safety feature.

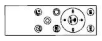
Part List and Hardware List

PIECE	DESCRIPTION	PICTURE	QUANTITY	PIECE	DESCRIPTION	PICTURE	QUANTITY
A	mounting bracket		1X	F	screw		4X
B	tapping screw		4X	G	allen wrench		1X
C	Wall plug		4X	H	transformer		1X
D	Iron tube		2X	I	the remote control		1X
E	main body stents						1X

JONATHAN Y

Model#: JYL9552A

Product Dimensions: 18.25"L x 18.25"W x 44"H

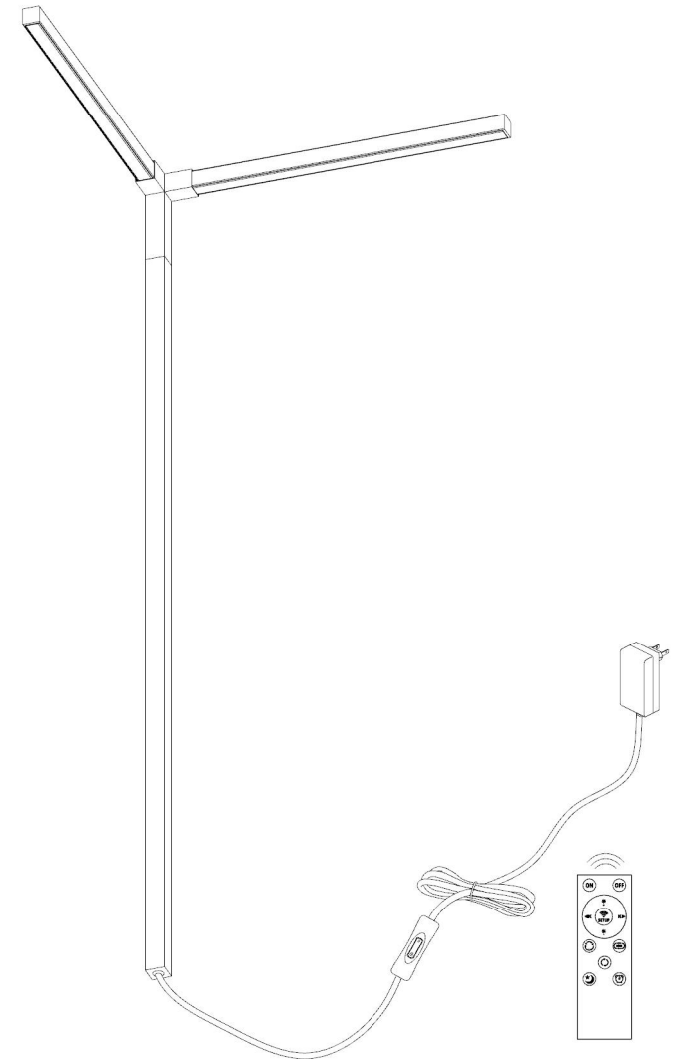

PREPARATION

Before beginning assembly of product, make sure all parts are present. Compare parts with package contents list and hardware contents list. If any part is missing or damaged, do not attempt to assemble the product.

Estimated Assembly Time: 20 minutes.

If there are any questions relating to defects, missing parts, assembly issues, replacements, or device connectivity issues, please send a detailed email to cs@jonathany.com

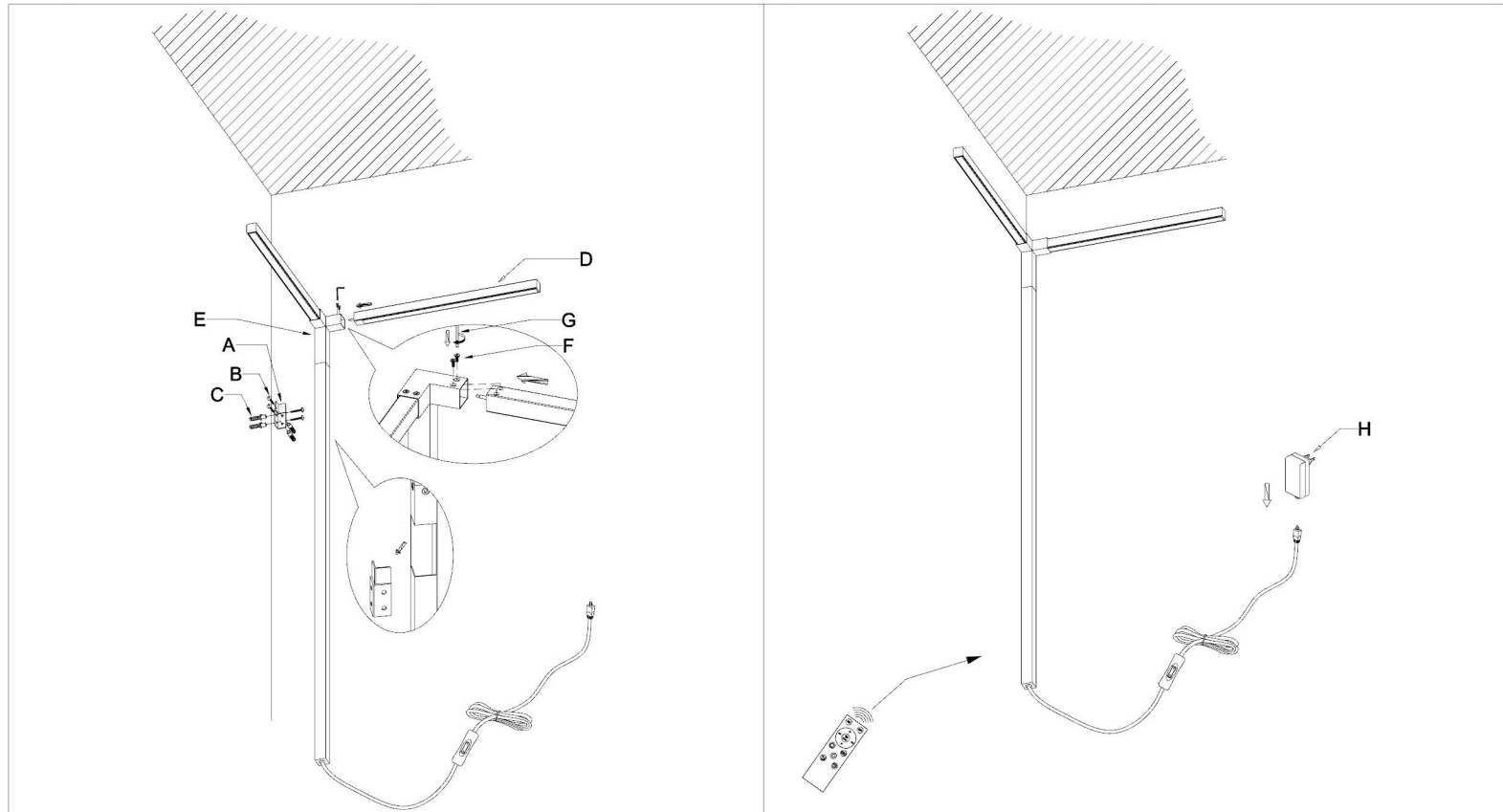

1. Fix tapping screw(B) and Wall plug(C) to fix mounting bracket(A) on the corner.
(Check whether the plug is damaged before installation. If so, do not install it)
2. Fix Iron tube(D) and main body stents(E) with screw(F) and allen wrench(G).
3. Insert transformer(H) correctly.
4. Adjust the lights with the remote control.

Use of remote control

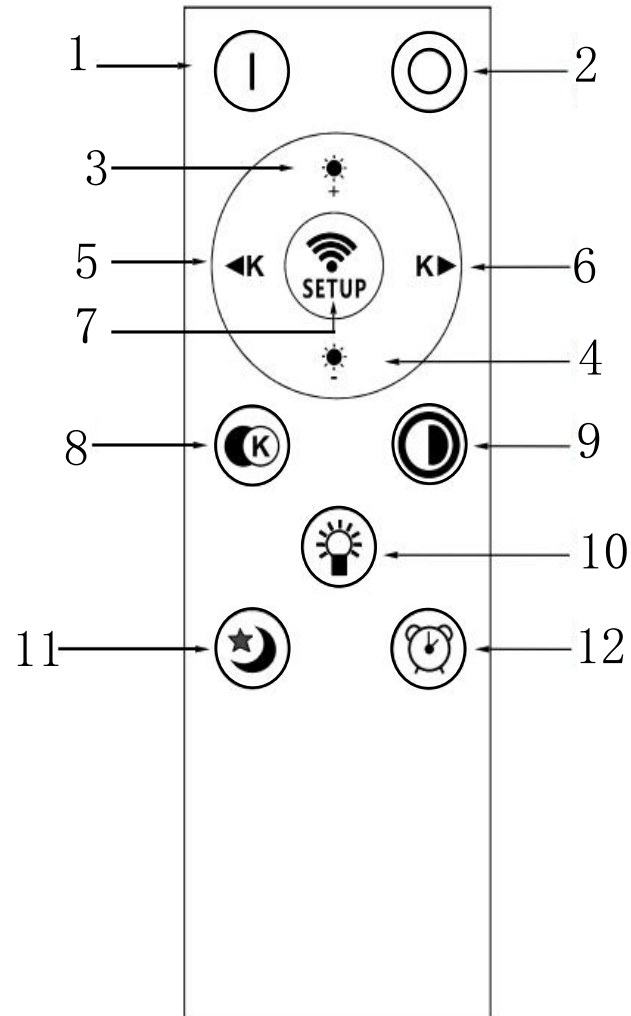

Use of intelligent remote control

No.	Key	Use of Remote Control	Guide of Remote Control
1		LIGHT ON	Short press for turning on Long press within 10S after device connect to the power till the light is off and on again for matching code.
2		LIGHT OFF	Short press for turning off Long press within 10S after device connect to the power till the light is off and on again for canceling code.
3		Brightness Increase	Short press for brightness increase Long press: The brightness of the main light source continues to increase slowly
4		Brightness Decrease	Short press for brightness decrease Long press: The brightness of the main light source continues to slowly decrease
5		Color Temperature Decrease	Short press for color temperature decrease Long press: The color temperature of the main light source continues to slowly decrease
6		Color Temperature Increase	Short press for color temperature increase Long press: The color temperature of the main light source continues to slowly increase
7		Network Matching	Long press "SETUP" 5S till the device match network.
8		Color Temperature Switching	Short press :the main light source cold light / mixed light / warm light switching
9		Brightness Switching	Short press for 50% & 100% brightness switching
10		Secondary Light Source	Short press for secondary light source On / Off .
11		Night Light	Short press for Night light Mode
12		LIGHT OFF Delay	Short press for turning off the device with 60s delay

Pairing JONATHAN Y Mobile

Intelligent Function

In addition to the included control , you can operate your device with the JONATHAN Y app.

Upgradeable with Smart Features

Scan the code below with your phone to find out how you can enable smart features through the JONATHAN Y app and integrate with your smart home ecosystem.

Downloading JONATHAN Y Mobile APP

1. To use the JONATHAN Y app , download it from the App Store or Google Play.
2. Open the app to create your account.
3. To set up a Wi-Fi connection you will need the SSID and Wi-Fi password for the network you wish to connect to.
4. You can name your device if you choose.



Pairing JONATHAN Y Mobile APP

Scan the QR code to download the "JONATHAN Y " APP

- a. Download and Open "JONATHAN Y" Mobile App.
- b. Press the + button in the top right corner of the mobile App.
- c. Under "Add Manually" select "Smart bulb".
- d. Type in your Wi-Fi name & password then proceed to click "Next".
- e. Press "SETUP" on the remote control for 5S. The device blinks once before blinking rapidly.
- f. Click "Confirm indicator rapidly blink"
- g. After the loading screen go back to homepage and you should be able to find your device there.

Withdrawing JONATHAN Y Mobile APP

Press "SETUP" on the remote control for 5S till device blinks once before blinking rapidly to cancel network, if you prefer not using the app or broadcasting Wi-Fi.

Q&A

Q : If you cannot pair the JONATHAN Y APP

A : 1 . Please check whether the WI-FI network is 2.4g.

2. Turn off the power and turn on the power again. Long press "SETUP" on the remote control for 5S till device blinks once before blinking rapidly.

3. Pairing JONATHAN Y Mobile APP again.

Q : If your remote cannot control the receiver.

A : 1. Please turn off the power.

2. Turn on the power again.

3. Long press "ON" on the remote control within 10S till the light is off and on again.

ENJOY YOUR LAMP