

WARNING

WE RECOMMEND INSTALLATION OF THIS LIGHTING FIXTURE BE DONE BY A LICENSED ELECTRICIAN.

WARNING *** SWITCH OFF THE MAIN ELECTRICAL SUPPLY FROM THE MAIN FUSE BOX/CIRCUIT BREAKER BEFORE INSTALLATION.

INSPECT ITEM CAREFULLY BEFORE ATTEMPTING TO INSTALL. IF THERE IS ANY DAMAGE OR

CARE AND MAINTENANCE

To clean the outside of the fixture, use a dry or slightly dampened clean cloth (use clean water, never a solvent) to wipe the surface of the fixture.

To clean the inside of the fixture, first disconnect power to the fixture by turning off the circuit breaker or by removing the fuse at the fuse box. Next, use a dry or slightly dampened clean cloth (use clean water, never a solvent) to wipe the interior surface of the fixture.

Do not use any cleaners with chemical, solvents or harsh abrasives. Use only a dry soft cloth to dust or wipe carefully.

NOTICE& IMPORTANT SAFETY INSTRUCTIONS

* Please make sure that you have all parts indicated before you begin assembly of this item







* This item should be assembled on a soft surface to prevent scratching the finish during assembly

* To reduce the risk of fire, electrical shock or injury to persons or property, please follow the guideline below for safe use and installation

*The external flexible cable or cord of this luminaire cannot be replaced

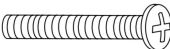
If the cord is damaged, the luminaire shall be destroyed

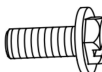
Part List and Hardware List

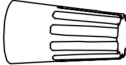
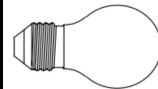
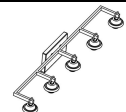
PIECE	DESCRIPTION	PICTURE	QUANTITY	PIECE	DESCRIPTION	PICTURE	QUANTITY
A	Mounting Bracket		1X	F	Glass Shade		5X
B	Mounting Screw		2X	G	Socket Nut		5X
C	Ground Screw		1X	H	Canopy Nut		2X
D	Wire Nut		3X	I	Bulb		5X
E	Fixture Body		1X				

JONATHAN Y

Model#: JYL7901

Product Dimensions: 36.5"W X 7.5"E X 8.5"H

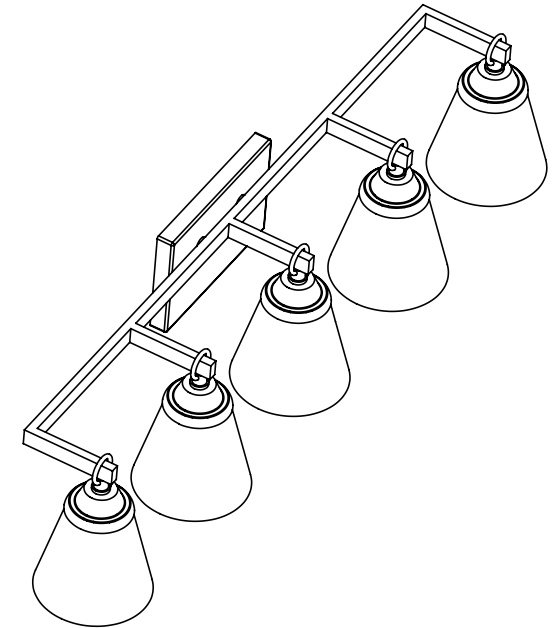

PREPARATION

Before beginning assembly of product, make sure all parts are present. Compare parts with package contents list and hardware contents list. If any part is missing or damaged, do not attempt to assemble the product.

Estimated Assembly Time: 20 minutes.

If there are any questions relating to defects, missing parts, assembly issues, replacements, or device connectivity issues, please send a detailed email to cs@jonathany.com

1. Unscrew the two canopy nuts (H) from the mounting bracket (A).
2. Fasten the mounting bracket (A) onto the outlet box using two outlet box screws (B).

Connect, Hot, Black or Red outlet Supply Wire to:	Connect, Neutral, White Outlet Supply Wire to:
Black	White
*Parallel Cord (round & smooth)	* Parallel Cord (square & ridged)
Clear, Brown, Gold or Black without Tracer (colored stripes)	Clear, Brown, Gold or Black with Tracer (colored stripes)
Insulated Wire (not green) with copper metal conductor	Insulated Wire (not green) with Silver metal conductor.

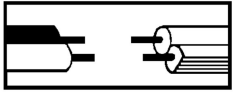

*Note: When parallel wire (SPT I & SPT II) is used. The neutral wire is square shaped and ridged and the hot wire will be round in shape and smooth. (See Illustration on left.)

Grounding Instructions:

- a) For installation in the United States: Wrap ground wire from outlet box around green ground screw on mounting bracket, no less than 2" from wire end. Tighten ground screw. If fixture is supplied with a ground wire, connect to outlet ground wire with a wire connector.
 - b) For installation in Canada: If fixture is supplied with ground wire, wrap ground wire around green grounding screw on mounting bracket. Tighten ground screw.
3. Attach the fixture body (E) to the mounting bracket (A) and fix it by turning the Canopy Nut (H) clockwise.
 4. Loosen the socket nuts (G) from the sockets of the fixture body (E), please the glass shades (F) over the sockets and secure with the socket nut (G).
 5. Insert the bulbs (I) into the socket until secure.

DO NOT EXCEED THE SPECIFIED WATTAGE.

PLEASE USE TYPE "A" BULB MAX 40-WATT OR LED MAX 9-WATT, THERE ARE LED 4-WATT BULB IN THE BOX.

ENJOY YOUR LAMP

