

WARNING

WE RECOMMEND INSTALLATION OF THIS LIGHTING FIXTURE BE DONE BY A LICENSED ELECTRICIAN.
WARNING *** SWITCH OFF THE MAIN ELECTRICAL SUPPLY FROM THE MAIN FUSE BOX/CIRCUIT BREAKER BEFORE INSTALLATION.
INSPECT ITEM CAREFULLY BEFORE ATTEMPTING TO INSTALL. IF THERE IS ANY DAMAGE OR OBVIOUS DEFECT, DO NOT INSTALL. ITEM MAY NOT BE RETURNED ONCE IT HAS BEEN INSTALLED.

CARE AND MAINTENANCE

To clean the outside of the fixture, use a dry or slightly dampened clean cloth (use clean water, never a solvent) to wipe the surface of the fixture.



















To clean the inside of the fixture, first disconnect power to the fixture by turning off the circuit breaker or by removing the fuse at the fuse box. Next, use a dry or slightly dampened clean cloth (use clean water, never a solvent) to wipe the interior surface of the fixture.

Do not use any cleaners with chemical, solvents or harsh abrasives. Use only a dry soft cloth to dust or wipe carefully.

NOTICE& IMPORTANT SAFETY INSTRUCTIONS

- * Please make sure that you have all parts indicated before you begin assembly of this item
- * This item should be assembled on a soft surface to prevent scratching the finish during assembly
- * To reduce the risk of fire, electrical shock or injury to persons or property, please follow the guideline below for safe use and installation
- *The external flexible cable or cord of this luminaire cannot be replaced
If the cord is damaged, the luminaire shall be destroyed

Part List and Hardware List

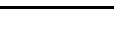
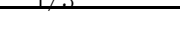
PIECE	DESCRIPTION	PICTURE	QUANTITY	PIECE	DESCRIPTION	PICTURE	QUANTITY
A	wire connector		3X	K	short mounting bracket		2X
B	mounting plate		1X	L	long mounting bracket		3X
C	ground screw		1X	M	wood screw		10X
D	machine screw		2X	N	screw		5X
E	screwed ball		2X	O	hex kry		1X
F	lamp body		1X	P	towel ring		1X
G	ball screw		9X	Q	robe hook		1X
H	bulb		3X	R	toilet paper holder		1X
I	shade		3X	S	body of towel bar		2X
J	wall anchors		10X	T	towel bar		1X



Model#: JYL1506

Product Dimensions: 24"W X7.5"E X11"H

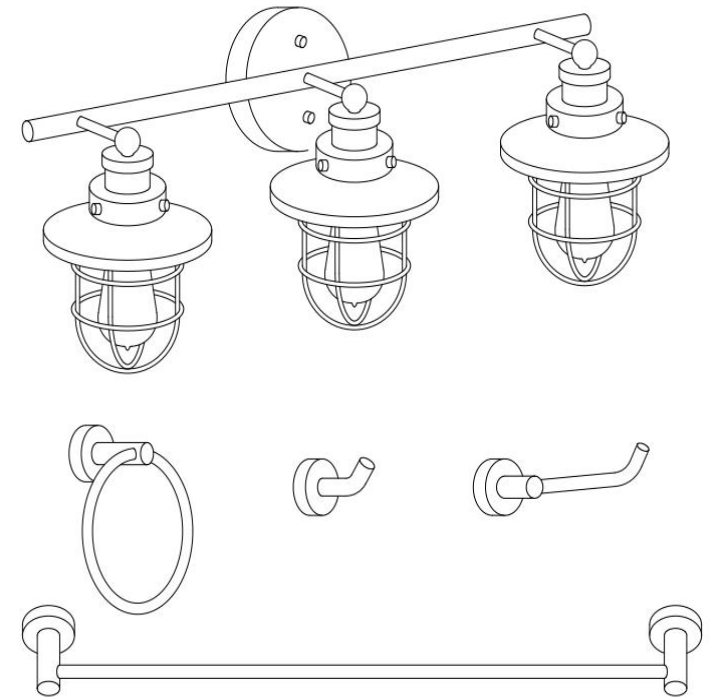

PREPARATION

Before beginning assembly of product, make sure all parts are present. Compare parts with package contents list and hardware contents list. If any part is missing or damaged, do not attempt to assemble the product.

Estimated Assembly Time: 20 minutes.

If there are any questions relating to defects, missing parts, assembly issues, replacements, or device connectivity issues, please send a detailed email to cs@jonathany.com

1. Separate the mounting plate (B) from the lamp body (F) by removing the screwed ball (E) anti-clockwise. then fix the mounting plate (B) to the outlet box with machine screw (D).

2. Make wire connections, with wire connectors(A), following the reference chart listed below.

Connect, Hot, Black or Red Outlet Supply Wire to:	Connect, Neutral, White Outlet Supply Wire to:
Black	White
* Parallel Cord (round & smooth)	* Parallel Cord (square & ridged)
Clear, Brown, Gold or Black without Tracer (colored stripes)	Clear, Brown, Gold or Black with Tracer (colored stripes)
Insulated Wire (not green) with copper metal conductor	Insulated Wire (not green) with Silver metal conductor.

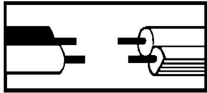

*Note: When parallel wire (SPT I & SPT II) is used. The neutral wire is square shaped and ridged and the hot wire will be round in shape and smooth. (See Illustration on left.)

Grounding Instructions:

- For installation in the United States: Wrap ground wire from outlet box around green ground screw (C) on mounting plate, no less than 2" from wire end. Tighten ground screw. If fixture is supplied with a ground wire, connect to outlet ground wire with a wire connector.
- For installation in Canada: If fixture is supplied with ground wire, wrap ground wire around green grounding screw on mounting plate. Tighten ground screw.

- Orient the ceiling canopy of the lamp body (F) so that the mounting screws protruding from the mounting plate (B) go into the holes in the canopy of the lamp body (F), then secure it with the provided screwed balls (E).
- Install bulb (H). Be sure to use light bulb(s) with wattage no greater than specified on this fixture. Always make sure that electrical current is turned off before changing bulbs.
- Attach the shade (I) to the socket cap and then fixed using the ball screw (G).

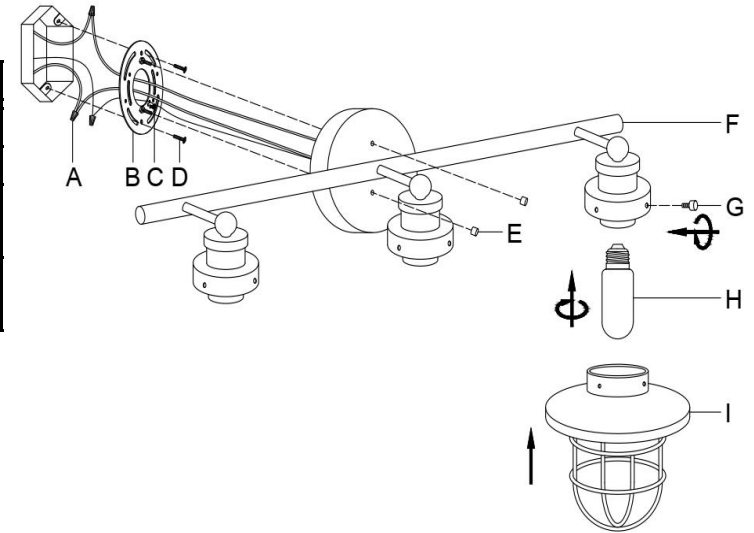

**PLEASE USE ON/OFF TYPE "A" BULB MAX 40-WATT OR LED BULB MAX 9 -WATT
THERE ARE 3PCS 4WATT LED BULB IN THE BOX**

ENJOY YOUR LAMP

Installing the towel ring

1. Determine the location for the towel ring (P). Using the short mounting bracket (K) as a template, mark the location of the holes for the wall anchors (J). Drill the appropriate size holes for the wall anchors (J). (the holes should be slightly smaller than the size of the wall anchors (J).). The wall anchors (J) are then punched into the drilled holes, And allowing for the wood screws (M) to protrude through the hole on short mounting bracket (K), then screw the wood screw (M) to the wall anchors (J).

2. Place the towel ring (P) over the short mounting bracket (K) and use the hex key (O) to secure it in place by using screw (N).

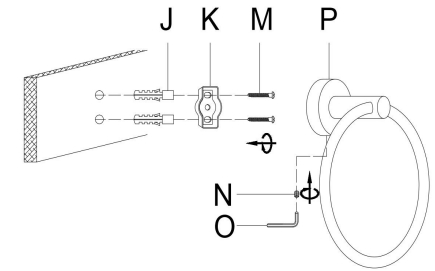

Installing the robe hook

1. Determine the location for the robe hook (Q). Using the short mounting bracket (K) as a template, mark the location of the holes for the wall anchors (J). Drill the appropriate size holes for the wall anchors (J). (the holes should be slightly smaller than the size of the wall anchors (J).). The wall anchors (J) are then punched into the drilled holes, And allowing for the wood screws (M) to protrude through the hole on short mounting bracket (K), then screw the wood screw (M) to the wall anchors (J).

2. Place the robe hook (Q) over the short mounting bracket (K) and use the hex key (O) to secure it in place by using screw (N).

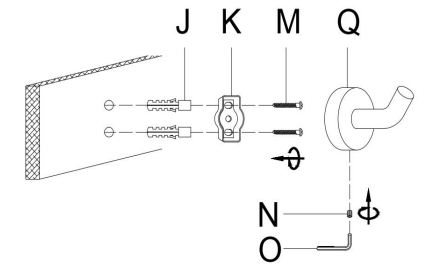

Installing the toilet paper holder

1. Determine the location for the toilet paper holder (R). Using the long mounting bracket (L) as a template, mark the location of the holes for the wall anchors (J). Drill the appropriate size holes for the wall anchors (J). (the holes should be slightly smaller than the size of the wall anchors (J).). The wall anchors (J) are then punched into the drilled holes, And allowing for the wood screws (M) to protrude through the hole on long mounting bracket (L), then screw the wood screw (M) to the wall anchors (J).

2. Place the toilet paper holder (R) over the long mounting bracket (L) and use the hex key (O) to secure it in place by using screw (N).

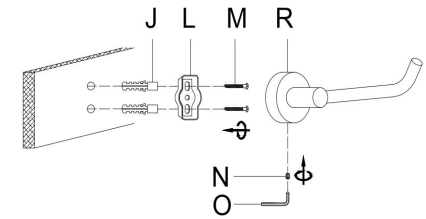

Installing the towel bar

1. Place the towel bar (T) to the body of towel bar (S).

2. Determine the location for the body of towel bar (S). Using the long mounting bracket (L) as a template, mark the location of the holes for the wall anchors (J). Drill the appropriate size holes for the wall anchors (J). (the holes should be slightly smaller than the size of the wall anchors (J).). The wall anchors (J) are then punched into the drilled holes, And allowing for the wood screws (M) to protrude through the hole on long mounting bracket (L), then screw the wood screw (M) to the wall anchors (J).

3. Place the body of towel bar (S) over the long mounting bracket (L) and use the hex key (O) to secure it in place by using screw (N).

