

CARE AND MAINTENANCE

















Unplug lamps before using any cleaning solutions. Dust shades with a feather duster or with an appropriate vacuum-brush attachment. Wipe with a soft, dry cloth and clean lamp bases with the methods appropriate to the material. Avoid the use of chemicals and household cleaners as they may damage the finish.

NOTICE & IMPORTANT SAFETY INSTRUCTIONS

- * Please make sure that you have all parts indicated before you begin assembly of this item
- * This item should be assembled on a soft surface to prevent scratching the finish during assembly
- * To reduce the risk of fire, electrical shock or injury to persons or property, please follow the guideline below for safe use and installation
- *The external flexible cable or cord of this luminaire cannot be replaced;
If the cord is damaged, the luminaire shall be destroyed

**This portable lamp has a polarized plug (one blade is wider than the other) as a safety feature to reduce the risk of electric shock. this plug will fit in a polarized outlet only one way. if the plug does not fit fully in the outlet, reverse the plug, if it still does not fit, contact a qualified electrician. never use with an extension cord unless the plug can be fully inserted. do not attempt to defeat this safety feature.

Part List and Hardware List

PIECE	DESCRIPTION	PICTURE	QUANTITY	PIECE	DESCRIPTION	PICTURE	QUANTITY
A	Lamp base		1X	J	Big spanner		1X
B	Sheet iron		1X	K	Socket		1X
C	Lamp body		3X	L	Shade		1X
D	Lamp body 1		1X	M	Out Ring		1X
E	Lamp body 2		2X	N	Bulb		1X
F	Lamp Body(bend)		1X	O	Nut		2X
G	Gasket		1X	P	Small spammer		1X
H	Screw		1X	Q	Knob		1X
I	Screw		1X				

JONATHAN Y

Model# JYL8504

Product Dimensions: 41*15*60-70"

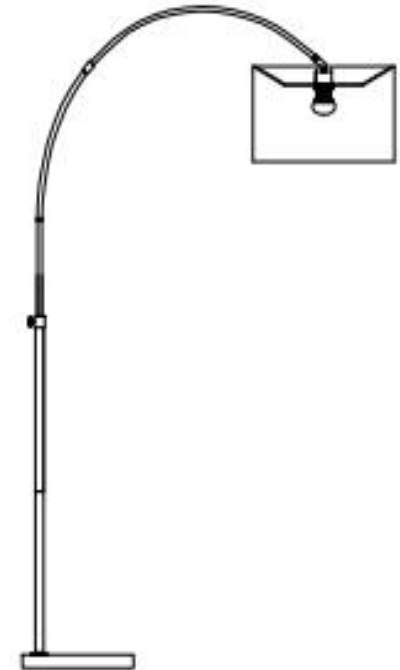

PREPARATION

Before beginning assembly of product, make sure all parts are present. Compare parts with package contents list and hardware contents list. If any part is missing or damaged, do not attempt to assemble the product.

Estimated Assembly Time: 15 minutes.

PLEASE USE ON/OFF TYPE "A" BULB MAX 100-WATT OR CFL BULB MAX 23-WATT OR LED BULB MAX 12-WATT

THERE IS LED 9.5-WATT SMART BULB IN THE BOX

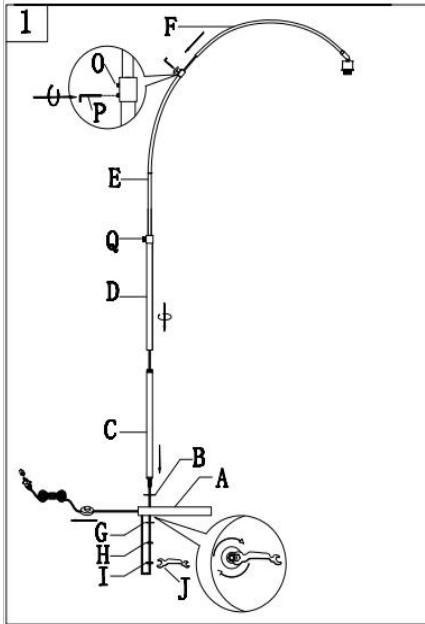

Step 1

Make sure all parts could be aligned before assemble
Unpack all parts from cartons carefully.

Insert the Lamp Body(D) into the Lamp Body (C),
Insert the Lamp Body(C) into the Lamp Base (A)
through the sheet iron(B),Gasket(G) and Screw(H),
Fix the screw(I)on bottom of base(A)by using Big spanner(J).
Insert the Lamp Body(bend)(F) into the Lamp Body (E),
then fix the nut(O) on it by using Small Spanner(P).

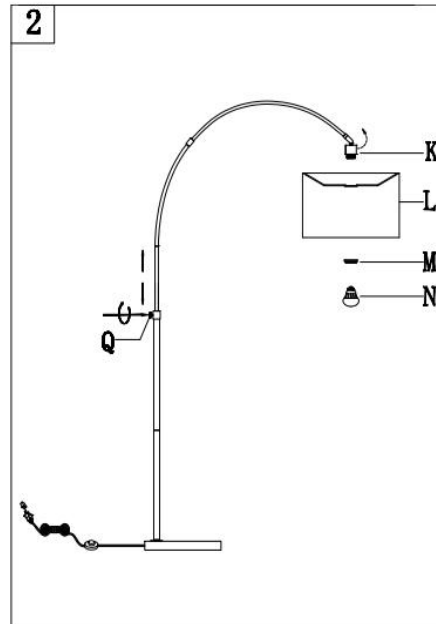

Step 2

Put the shade(L) on the socket(K),then
tighten the out ring(M) on it.
Insert the bulb(N) into the socket(K).
Please unscrew the knob (Q) first before
adjust the lamp height, and screw the knob(Q)
to tight after lamp height adjust finished

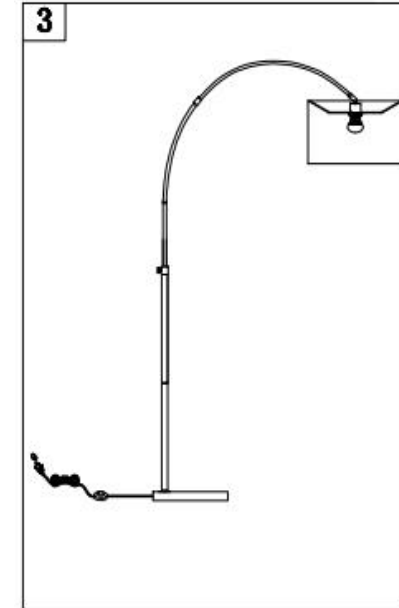

Put the light on a level surface to check
if everything is stable.

ENJOY YOUR LAMP

