

WARNING

WE RECOMMEND INSTALLATION OF THIS LIGHTING FIXTURE BE DONE BY A LICENSED ELECTRICIAN.
WARNING *** SWITCH OFF THE MAIN ELECTRICAL SUPPLY FROM THE MAIN FUSE BOX/CIRCUIT BREAKER BEFORE INSTALLATION.

INSPECT ITEM CAREFULLY BEFORE ATTEMPTING TO INSTALL. IF THERE IS ANY DAMAGE OR OBVIOUS DEFECT, DO NOT INSTALL. ITEM MAY NOT BE RETURNED ONCE IT HAS BEEN INSTALLED.

CARE AND MAINTENANCE

To clean the outside of the fixture, use a dry or slightly dampened clean cloth (use clean water, never a solvent) to wipe the surface of the fixture.

To clean the inside of the fixture, first disconnect power to the fixture by turning off the circuit breaker or by removing the fuse at the fuse box. Next, use a dry or slightly dampened clean cloth (use clean water, never a solvent) to wipe the interior surface of the fixture.

Do not use any cleaners with chemical, solvents or harsh abrasives. Use only a dry soft cloth to dust or wipe carefully.

NOTICE & IMPORTANT SAFETY INSTRUCTIONS

* Please make sure that you have all parts indicated before you begin assembly of this item











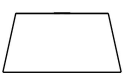



* This item should be assembled on a soft surface to prevent scratching the finish during assembly

* To reduce the risk of fire, electrical shock or injury to persons or property, please follow the guideline below for safe use and installation

*The external flexible cable or cord of this lamp cannot be replaced

If the cord is damaged, the lamp shall be destroyed

Part List and Hardware List

PIECE	DESCRIPTION	PICTURE	QUANTITY	PIECE	DESCRIPTION	PICTURE	QUANTITY
A	Lamp Body		1X	H	Finial		1X
B	Tube		1X	I	Bulb		3X
C	Glass		2X	J	Canopy		1X
D	Rubber Gasket		1X	K	Mounting Plate		1X
E	Iron Sheet		1X	L	Wire Nut		3X
F	Nut		1X	M	Mounting Screw		2X
G	Lid		1X	N	Screw		2X

JONATHAN Y

Model#: JYL9922

Product Dimensions: Ø15"X11.5"H

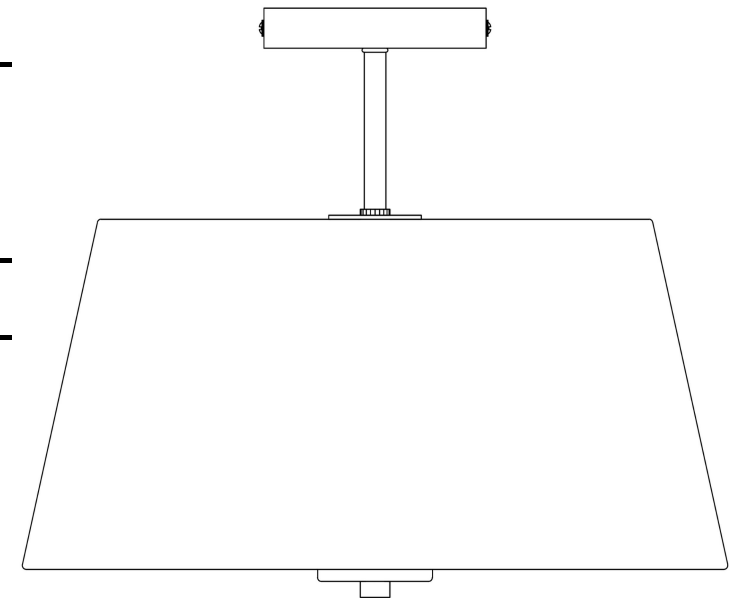

PREPARATION

Before beginning assembly of product, make sure all parts are present. Compare parts with package contents list and hardware contents list. If any part is missing or damaged, do not attempt to assemble the product.

Estimated Assembly Time: 30 minutes.

1. Separate the Mounting Plate(K) from the Canopy(J) by removing the Screw(N) anti-clockwise.
2. Fix the suction top Canopy(J) clockwise to the Lamp Body (A)
3. Attach the Mounting Plate (K) onto the J-box and secure it by turning 2 Mounting Screws (M) clockwise till tight.

Connect, Hot, Black or Red Outlet Supply Wire to:	Connect, Neutral, White Outlet Supply Wire to:
Black	White
* Parallel Cord (round & smooth)	* Parallel Cord (square & ridged)
Clear, Brown, Gold or Black without Tracer (colored stripes)	Clear, Brown, Gold or Black with Tracer (colored stripes)
Insulated Wire (not green) with copper metal conductor	Insulated Wire (not green) with Silver metal conductor.

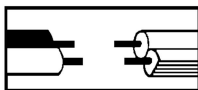

*Note: When parallel wire (SPT I & SPT II) is used. The neutral wire is square shaped and ridged and the hot wire will be round in shape and smooth. (See Illustration on left.)

Grounding Instructions:

- a) For installation in the United States: Wrap ground wire from outlet box around green ground screw on mounting bracket, no less than 2" from wire end. Tighten ground screw. If fixture is supplied with a ground wire, connect to outlet ground wire with a wire connector.
 - b) For installation in Canada: If fixture is supplied with ground wire, wrap ground wire around green grounding screw on mounting bracket. Tighten ground screw.
4. Attach the Canopy of the Lamp body(A) to the Mounting Plate (K) and fix it by turning the Screw (N) clockwise.
 5. Screw the tube(B) onto the threaded part at the bottom of junction box.
 6. Insert the bulbs (I) into the Sockets. Be sure to use light bulb(I) with wattage no greater than specified on this fixture. Make sure that electrical current is turned off before changing bulbs.
 7. Pass the middle holes of Glass (C), Rubber Gasket (D) and Iron Sheet (E) through the Tube (B) in turn, and then fix them with Nut (F)
 8. Pass the middle hole of the flat Lid (G) through the Tube (B) and then fix it with the Finial (H)

**PLEASE USE TYPE "B" BULB MAX 40-WATT OR CFL BULB MAX 13-WATT OR LED MAX 9-WATT
THERE ARE 3 X 4W LED BULBS IN THE BOX.**

ENJOY YOUR LAMP

