

# JONATHAN Y

## Assembly Instruction

**CAUTION:** Read instruction carefully and turn electricity off at main circuit breaker panel before beginning installation.

**ITEM#:JYL1401A**

**Product Dimensions: 13"Lx 13"W x 18"-198"H**

**Note: 2 Assembly Options**

Option 1: Portable lamp with plug

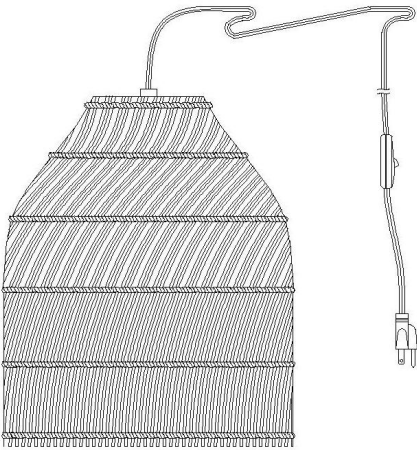

Option 2: Hard wired

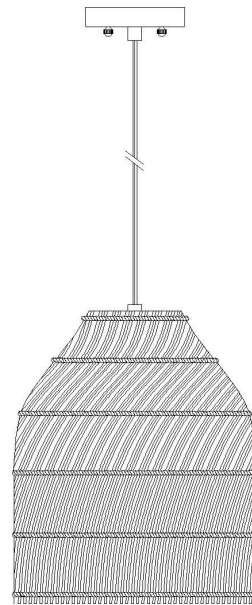

## Care and Cleaning









To clean the outside of the fixture, use a dry or slightly dampened clean cloth (use clean water, never a solvent) to wipe the surface of the fixture.

To clear the inside of the fixture, first disconnect power to the fixture by turning off the circuit breaker or by removing the fuse at the fuse box. Next, use a dry or slightly dampened clean cloth (use clean water, never a solvent) to wipe the interior surface of the fixture.

Do not use any cleaners with chemical, solvents or harsh abrasives. Use Only a dry soft cloth to dust or wipe carefully.

# Option 1: Assembly instruction(portable)

## Part List

PIECE	DESCRIPTION	PICTURE	QUANTITY	PIECE	DESCRIPTION	PICTURE	QUANTITY
A	Anchor		4X	E	Socket		1X
B	Screw		4X	F	Shade		1X
C	J-hook		1X	G	Socket Ring		1X
D	Hook		3X	H	Bulb		1X

PLEASE LOCATE ALL ITEMS BEFORE THROWING AWAY THE BOX

Estimated Assembly Time:30 minutes





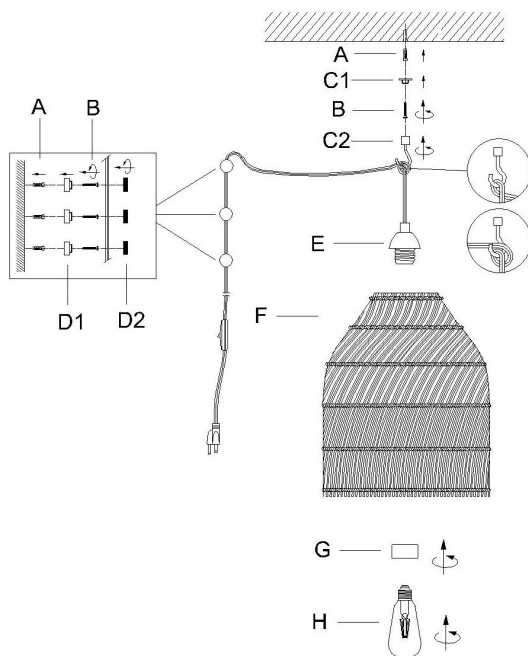







1. Drill two holes with depth 1-1/8" into the firm ceiling at the desired location for the lamp (D),Install two anchor (A) into the holes.
2. Insert the screw(B) through J-hook (C1) into the anchor (A)and tap gently with a hammer to set anchors firmly in place.  
Then install J-hook(C2).
3. Adjust the desired location on the cord of lamp (F), Wrap the wire around the J-hook(C) twice.  
Note: Do not twist the cord.
4. Insert the screw(B) through hook (D1) into the anchor (A)and tap gently with a hammer to set anchors firmly in place.
5. Put the wire into the hook(D1), then install hook(D2).  
Note: Do not twist the cord.
6. Put the shade(F) on to the Socket(E), then screw the socket ring(G) into the socket.
7. Install bulb(H). Be sure to use light bulb(H) with wattage no greater than specified on this fixture.  
Always make sure that electrical current is turned off before changing bulbs.
8. Use the inline switch on cord to turn light on/off.
9. Do not install on a radiant-heating ceiling.

**PLEASE USE ON/OFF TYPE"A" BULB MAX 100-WATT OR LED BULB MAX 12 -WATT  
THERE IS LED 4-WATT BULB IN THE BOX**

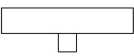

# Option 2: Assembly instruction(Hard wired)

## Part List and Hardware List

PIECE	DESCRIPTION	PICTURE	QUANTITY	PIECE	DESCRIPTION	PICTURE	QUANTITY
A	Wire Connrctor		3X	H	Wrench		1X
B	Mounting Bracket		1X	I	Socket		1X
C	Mounting Screws		2X	J	Shade		1X
D	Ground Screw		1X	K	Socket Ring		1X
E	Canopy		1X	L	Bulb		1X
F	Screwed Balls		2X	M	Bracket		1X
G	Screw Nut		1X				

## Installation

Before beginning assembly of product, make sure all parts are present. Compare parts with package contents list and hardware contents list. If any part is missing or damaged, do not attempt to assemble the product.

Estimated Assembly Time: 30 minutes.

- Carefully cut pre -attached plug ,cord and switch to your desired length as shown and discard the part plug and switch .
- Insert end of cord into corresponding hole of canopy ( E ),and mounting plate ( B ) as shown. Thread cord into bracket ( M ) as shown.

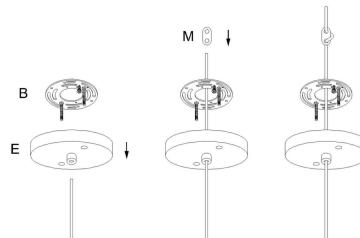
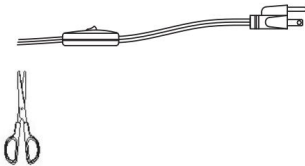

Note: Cuting the cord so that they are at least 6 inches (152.4mm) long within an outlet box and extend max. 3.1m long measured from the point where the cord emerges from the body of the lamp.

- Fix the mounting bracket(B) to the outlet box with machine screw(C).
- Make wire connections, with wire connectors(A), following the reference chart listed below.

Connect, Hot, Black or Red Outlet Supply Wire to:	Connect, Neutral, White Outlet Supply Wire to:
Black (Hot)	White (Neutral)
* Parallel Cord (round & smooth)	* Parallel Cord (square & ridged)
Clear, Brown, Gold or Black without Tracer (colored stripes)	Clear, Brown, Gold or Black with Tracer (colored stripes)
Insulated Wire (not green) with copper metal conductor	Insulated Wire (not green) with Silver metal conductor.

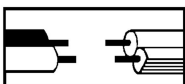

\*Note: When parallel wire ( SPT I & SPT II ) is used. The neutral wire is square shaped and ridged and the hot wire will be round in shape and smooth. ( See Illustration on left. )

Grounding Instructions:

- a) For installation in the United States: Wrap ground wire from outlet box around green ground screw(E) on mounting bracket, no less than 2" from wire end. Tighten ground screw(E). If fixture is supplied with a ground wire, connect to outlet ground wire with a wire connector.
- b) For installation in Canada: If fixture is supplied with ground wire, wrap ground wire around green grounding screw(E) on mounting bracket. Tighten ground screw(E).

- 5. Orient the ceiling canopy(F) so that the mounting screws(D) protruding from the mounting bracket go into the holes in the canopy, then secure it with the provided screwed balls(G).
- 6. Put the set screw(G) by the Wrench(H) to tighten.
- 7. Put the shade(J) on to the Socket(I), then screw the socket ring(K) into the socket.
- 8. Install bulb(L). Be sure to use light bulb(L) with wattage no greater than specified on this fixture. Always make sure that electrical current is turned off before changing bulbs.

**PLEASE USE ON/OFF TYPE "A" BULB MAX 100-WATT OR LED BULB MAX 12 -WATT  
THERE IS LED 4-WATT BULB IN THE BOX**

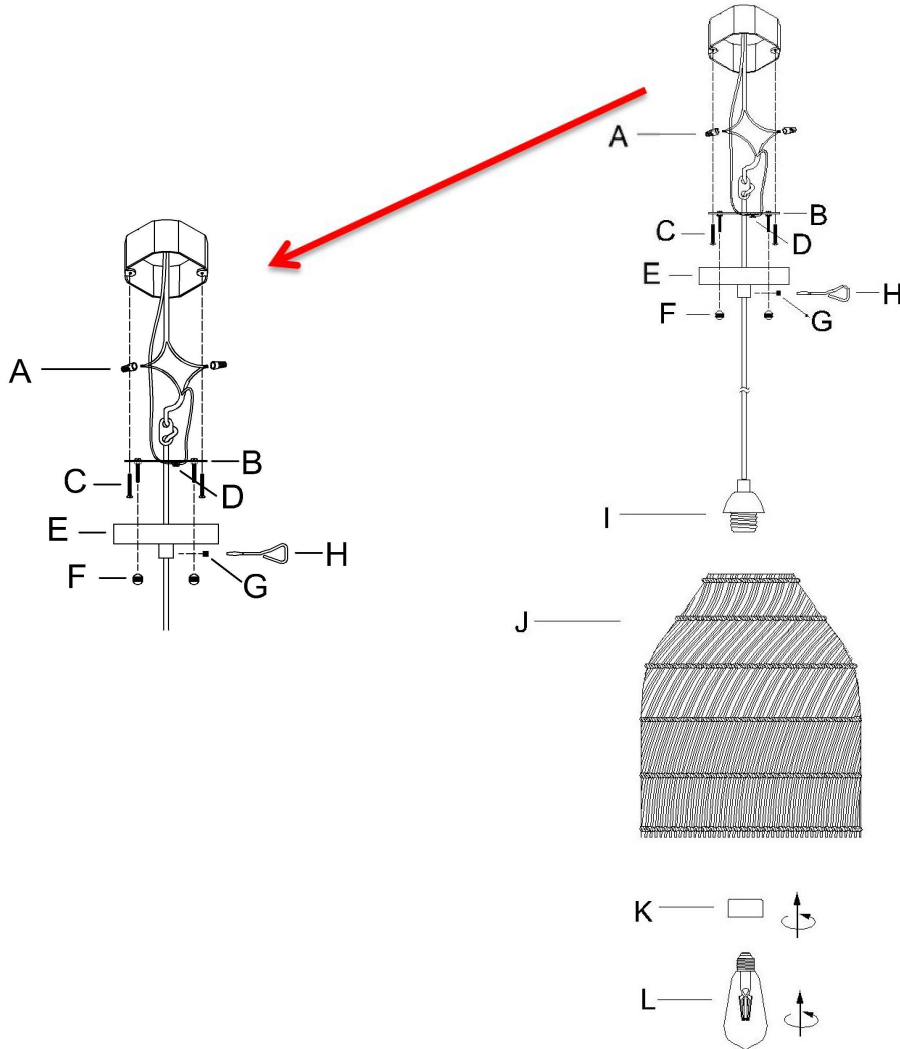

**ENJOY YOUR LAMP**