

WARNING

WE RECOMMEND INSTALLATION OF THIS LIGHTING FIXTURE BE DONE BY A LICENSED ELECTRICIAN. WARNING *** SWITCH OFF THE MAIN ELECTRICAL SUPPLY FROM THE MAIN FUSE BOX/CIRCUIT BREAKER BEFORE INSTALLATION. INSPECT ITEM CAREFULLY BEFORE ATTEMPTING TO INSTALL. IF THERE IS ANY DAMAGE OR OBVIOUS DEFECT, DO NOT INSTALL. ITEM MAY NOT BE RETURNED ONCE IT HAS BEEN INSTALLED.

CARE AND MAINTENANCE













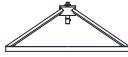

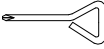

To clean the outside of the fixture, use a dry or slightly dampened clean cloth (use clean water, never a solvent) to wipe the surface of the fixture.

To clean the inside of the fixture, first disconnect power to the fixture by turning off the circuit breaker or by removing the fuse at the fuse box. Next, use a dry or slightly dampened clean cloth (use clean water, never a solvent) to wipe the interior surface of the fixture. Do not use any cleaners with chemical, solvents or harsh abrasives. Use only a dry soft cloth to dust or wipe carefully.

NOTICE & IMPORTANT SAFETY INSTRUCTIONS

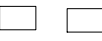
- * Please make sure that you have all parts indicated before you begin assembly of this item.
- * This item should be assembled on a soft surface to prevent scratching the finish during assembly.
- * To reduce the risk of fire, electrical shock or injury to persons or property, please follow the guideline below for safe use and installation.
- * The external flexible cable or cord of this lamp cannot be replaced. If the cord is damaged, the lamp shall be destroyed.

Part List and Hardware List

PIECE	DESCRIPTION	PICTURE	QUANTITY	PIECE	DESCRIPTION	PICTURE	QUANTITY
A	wire connector		3X	J	L12" tube		2X
B	mounting plate		1X	K	arm		1X
C	fixture screws		2X	L	square tube		4X
D	mounting screws		2X	M	screw		19X
E	ground screw		1X	N	Phillips screwdriver		1X
F	hex nut		2X	O	frame		1X
G	canopy		1X	P	tube		1X
H	finial		2X	Q	fixture body		1X
I	L6" tube		2X	R	bulb		5X

JONATHAN Y

Model#: JYL1323A

Product Dimensions: 16"Wx16"Ex30.5"-60.5"H

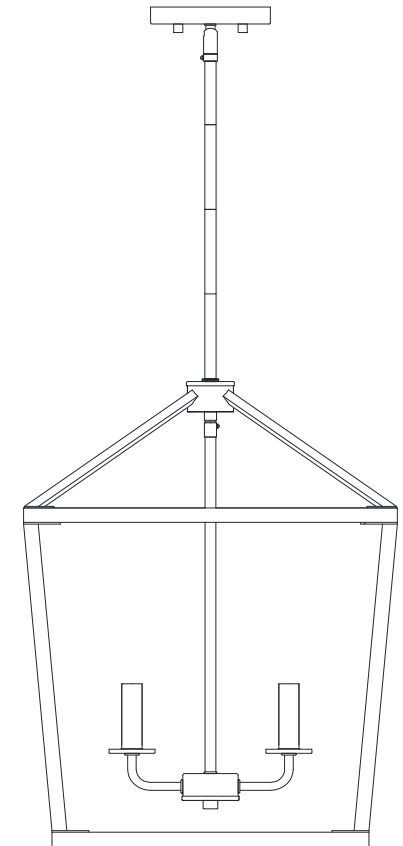

PREPARATION

Before beginning assembly of product, make sure all parts are present. Compare parts with package contents list and hardware contents list. If any part is missing or damaged, do not attempt to assemble the product.

Estimated Assembly Time: 20 minutes.

Step

1. Unscrew the screws (M) above the frame (O), align the screw holes of the frame (O) with the tooth holes A, B, C and D of the square tube (L), and lock them with the screws (M) and the Phillips Screwdriver (N).
2. Unscrew the screws (M) above the frame (K), align the screw holes of the frame (K) with the tooth holes A, B, C and D of the square tube (L), and lock them with the screws (M) and the Phillips Screwdriver (N).
3. Fix the four square tubes (L) to the hardware arm (K) with screws (M) and tighten with phillips screwdriver (N).
4. Fix the square tubes assembly to the hardware frame (O) with screw (M), and then tighten it with phillips screwdriver (N).
5. Twist the center tube (P) on the fixture body (Q), and then twist the other end of the center tube to arm (K).
6. Twist the L12" tube (J) and L6" tube (I) to the hardware arm (K) in turn.
7. Twist the canopy (G) to the L6" tube (I).
8. Lock the mounting plate (B) to the junction box on the ceiling with mounting screws (D).
9. Connect the positive and negative ends of the power cord on the lamp to the positive and negative ends of the power cord in the home junction box correctly with wire connector (A).
10. Lock the canopy (G) to the fixture screws (C) with the finial (H).
11. Lock the bulb (R) to the socket.

Connect, Hot, Black or Red Outlet Supply Wire to:	Connect, Neutral, White Outlet Supply Wire to:
Black	White
* Parallel Cord (round & smooth)	* Parallel Cord (square & ridged)
Clear, Brown, Gold or Black without Tracer (colored stripes)	Clear, Brown, Gold or Black with Tracer (colored stripes)
Insulated Wire (not green) with copper metal conductor	Insulated Wire (not green) with Silver metal conductor.

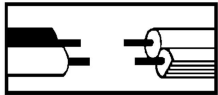

*Note: When parallel wire (SPT I & SPT II) is used. The neutral wire is square shaped and ridged and the hot wire will be round in shape and smooth. (See Illustration on left.)

Grounding Instructions:

a) For installation in the United States: Wrap ground wire from outlet box around green ground screw(E) on mounting bracket, no less than 2" from wire end. Tighten ground screw. If fixture is supplied with a ground wire, connect to outlet ground wire with a wire connector.

b) For installation in Canada: If fixture is supplied with ground wire, wrap ground wire around green grounding screw on mounting bracket. Tighten ground screw.

PLEASE USE TYPE"B" BULB MAX 40-WATT OR LED BULB MAX 9-WATT, THERE ARE 5PCS LED 4-WATT BULB IN THE BOX.

ENJOY YOUR LAMP

