



# PARTS LIST

**Bifold Hardware**



**Multi-Fold Hardware**



**Wall Mount Sliding Hardware**



**Pocket Door Hardware**



**Sliding Bypass Hardware**



**Multi-Door Sliding Hardware**



## JOHNSON HARDWARE

Manufacturing World Class  
Door Hardware Since 1958

PL-0517

May 1, 2017

For orders call: 800-348-7616

For information call: 800-837-5664

To order by Fax: 800-837-4697

Fax: 574-294-4697

e-mail: [sales@johnsonhardware.com](mailto:sales@johnsonhardware.com)

Web Site: [www.johnsonhardware.com](http://www.johnsonhardware.com)



L.E. Johnson Products, Inc.  
2100 Sterling Avenue  
Elkhart, IN 46516

**Bifold Hardware**  

200FD	.....	3
100FD	.....	3
111FD	.....	4
170A	.....	4
1700	.....	5
1718/1738/1734	.....	5
1770	.....	5
1825	.....	6
1838	.....	6
1601	.....	7

**Multi-Fold Hardware**  

200RD	.....	7
100RD	.....	8
1700RD	.....	8
1740	.....	8

**Wall Mounted Hardware**  

200WM	.....	9
2610F/2610FB	.....	9

**Pocket Door Hardware**  

2000	.....	10
2060	.....	10
1500	.....	11
1500SC	.....	12
1060	.....	12
1560	.....	13
1562	.....	13
2710	.....	14
2711	.....	14
2511	.....	15
1510/1511	.....	15
200PD	.....	16
200BP	.....	16
200MP	.....	17
100PD	.....	17
100BP	.....	18
100MP	.....	18
111PD	.....	19
111BP	.....	19
111MP	.....	20
1521/1534	.....	20
2800F	.....	21
2800/2850	.....	21
2041	.....	22
Valet Rod	.....	22

**Sliding Bypass Hardware**  

200SD	.....	23
100SD	.....	23
111SD	.....	24
134F	.....	24
138F	.....	25
118F	.....	25
2200F	.....	26
2204F	.....	26
2222	.....	27
2200	.....	27
1166	.....	28
1138	.....	28
113F	.....	28

**Multiple-Door Hardware**  

200MD	.....	29
100MD	.....	29
111MD	.....	29

**Bulk Items and Retail Packs**  

Bulk Track	.....	30
Merchandisers	.....	31
Retail Bubble Packs	.....	32
Bulk Parts	.....	33-36

**ORDERING DATA**

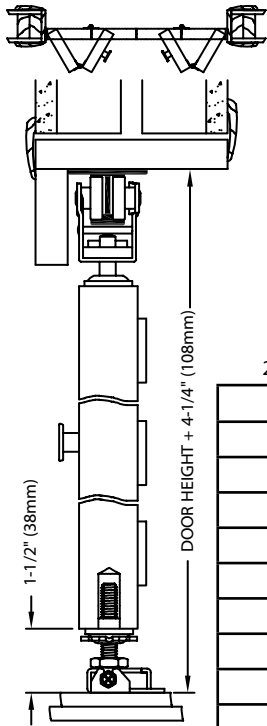

Item No.	Opening Size	Lbs/Case Qty.
200FD482	48" 2 Door	Bulk only-5/Case
200FD602	60" 2 Door	Bulk only-5/Case
200FD722	72" 2 Door	6/1
200FD962	96" 2 Door	8/1
200FD484	48" 4 Door	Bulk only-5/Case
200FD604	60" 4 Door	Bulk only-5/Case
200FD724	72" 4 Door	Bulk only-5/Case
200FD964	96" 4 Door	Bulk only-5/Case
2003	3.5x3.5 Hinge	9/10 pair



4 Door Hardware Set Shown Below

**2 Door Components**

Qty	Part #
1	200 Track
1	2010 Pivot Lock
1	2001 Pivot
1	2011 Piv Socket
1	2007 Bot Piv
1	2002 Hanger
1	37 Knob
1	1712 Wrench
1/2	1808 Aligner

**4 Door Components**

Qty	Part #
1	200 Track
2	2010 Pivot Lock
2	2001 Pivot
2	2011 Piv Socket
2	2007 Bot Piv
2	2002 Hanger
2	37 Knob
1	1712 Wrench
1	1808 Aligner



Available in:  
Bright Brass  
Satin Nickel  
Antique Brass  
Oil Rubbed Bronze

1 3/8", 1 3/4", and  
2 1/4" Side Mount  
Hardware  
Available



**200FD**

A premium commercial bifold hardware set for 12"-48" panels up to 9'0" high. Heavy duty I-beam track with positive pivot lock, top hung, four wheel (1" dia.) ball bearing hangers, heavy duty bottom pivot, floor bracket with screw adjusting bottom pivot socket. Plated steel parts. Hinges not included, order #2003 Hinges separately.

**ORDERING DATA**

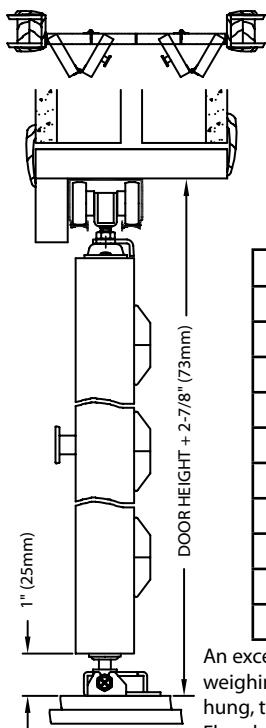

Item No.	Opening Size	Lbs/Case Qty
100FD362	36" 2 Door	15/5
100FD484	48" 4 Door	25/5
100FD604	60" 4 Door	26/5
100FD724	72" 4 Door	27/5
100FD964	96" 4 Door	21/3



4 Door Hardware Set Shown

**2 Door Components**

Qty	Part #
1	100 Track
1	1155 Track Stop
1	107 Piv-Set
1	1011 Piv Socket
1	1706 Bot Piv
3	1606 Hinges
1	33 Knob
1	1125 Hanger
1	1712 Wrench
1/2	1808 Aligner

**4 Door Components**

Qty	Part #
1	100 Track
2	1155 Track Stop
2	107 Piv-Set
2	1011 Piv Socket
2	1706 Bot Piv
6	1606 Hinges
2	33 Knob
2	1125 Hanger
1	1712 Wrench
1	1808 Aligner

An excellent commercial bifold hardware set for 12"-24" panels up to 9' high weighing 75 lbs. each. Convex rail aluminum track with positive pivot lock, top hung, three wheel (1" dia.) ball bearing hangers, non-mortise lift off hinges. Floor bracket has a screw adjusting bottom pivot socket. Brass-tone steel parts.



**100FD**



1 1/8", 1 3/8", and 1 3/4" Side Mount Hardware Available

# 111FD Top Mounted Bifold Hardware for 3/4" to 1 3/4" Thick Panels to 50 lbs.

## ORDERING DATA

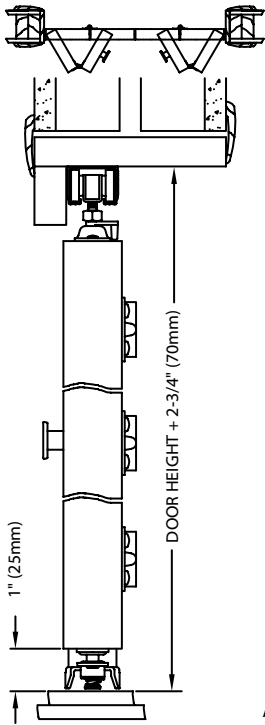

Item No.	Opening Size	Lbs/Case Qty
111FD362	36" 2 Door	11/5
111FD484	48" 4 Door	18/5
111FD604	60" 4 Door	19/5
111FD724	72" 4 Door	20/5
111FD964	96" 4 Door	16/3

### 2 Door Components

Qty	Part #
1	111 Track
1	1155 Track Stop
1	118 Piv-Set
1	1711 Jamb Brkt
1	1707 Bot Piv
3	1703 Hinges
1	33 Knob
1	1020 Hanger
1	1712 Wrench
1/2	1808 Aligner

### 4 Door Components

Qty	Part #
1	111 Track
2	1155 Track Stop
2	118 Piv-Set
2	1711 Jamb Brkt
2	1707 Bot Piv
6	1703 Hinges
2	33 Knob
2	1020 Hanger
1	1712 Wrench
1	1808 Aligner



4 Door Hardware Set Shown



## 111FD

A superior light commercial bifold hardware set for 12"-24" panels up to 9" high weighing 50 lbs. each. Convex rail aluminum track with positive pivot lock, top hung, three wheel (3/4" dia.) hangers, four-way adjustable jamb bracket, shock absorbing "breathing" hinges self locate and automatically align to door. Brass-tone steel parts.

# 170A Top Mounted Bifold Hardware for 3/4" to 1 3/4" Thick Panels to 40 lbs.

## ORDERING DATA

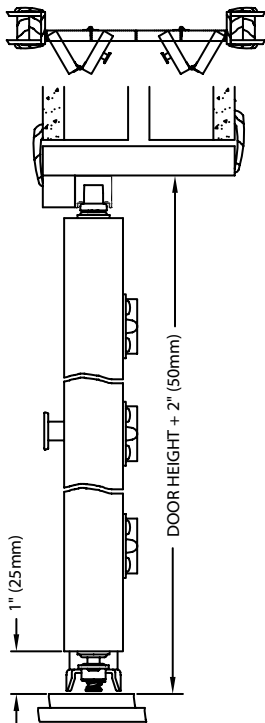

Item No.	Opening Size	Lbs/Case Qty
170A243H	24" 2 Door	9/5
170A303H	30" 2 Door	10/5
170A363H	36" 2 Door	11/5
170A486H	48" 4 Door	17/5
170A606H	60" 4 Door	18/5
170A726H	72" 4 Door	20/5
170A966H	96" 4 Door	23/5

### 2 Door Components

Qty	Part #
1	170A Track
1	1710 Pivot Lock
1	1713 Snubber
1	1701 Top Pivot
1	1711 Jamb Brkt
1	1707 Bot Piv
3	1703 Hinges
1	33 Knob
1	1705 Top Guide
1	1712 Wrench

### 4 Door Components

Qty	Part #
1	170A Track
2	1710 Pivot Lock
2	1701 Top Pivot
2	1713 Snubber
2	1711 Jamb Brkt
2	1707 Bot Piv
6	1703 Hinges
2	33 Knob
2	1705 Top Guide
1	1712 Wrench
1	1808 Aligner



4 Door Hardware Set Shown



## 170A

A premium residential bifold hardware set. Top hung hardware allows doors to hang naturally. Automatic top of the door spacing eliminates gaps. Smooth nonbinding operation. Heavy duty aluminum track with positive pivot lock. Surface mounted pivots and guides (no hole drilling). Four way adjustable jamb bracket, shock absorbing "breathing" hinges self locate and automatically align to door. Brasstone steel parts.

**ORDERING DATA**

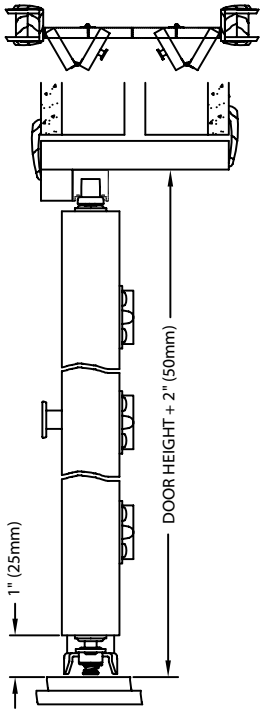

Item No.	Opening Size	Lbs./Case Qty
1700243H	24" 2 Door	9/5
1700303H	30" 2 Door	10/5
1700363H	36" 2 Door	11/5
1700486H	48" 4 Door	17/5
1700606H	60" 4 Door	18/5
1700726H	72" 4 Door	20/5
1700966H	96" 4 Door	23/5

**2 Door Components**

Qty	Part #
1	1700 Track
1	1710 Pivot Lock
1	1713 Snubber
1	1701 Top Pivot
1	1711 Jamb Brkt
1	1707 Bot Piv
3	1703 Hinges
1	33 Knob
1	1705 Top Guide
1	1712 Wrench

**4 Door Components**

Qty	Part #
1	1700 Track
2	1710 Pivot Lock
2	1713 Snubber
2	1701 Top Pivot
2	1711 Jamb Brkt
2	1707 Bot Piv
6	1703 Hinges
2	33 Knob
2	1705 Top Guide
1	1712 Wrench
1	1808 Aligner



4 Door Hardware Set Shown



Same features as the 170A, but with woodtone steel track.

Also available with white track.

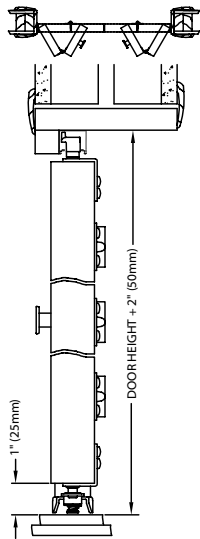

**4 Door Hardware Set Shown**



Same features as 1700 series, except hardware is mounted to back side of door. Side mount plates can be adjusted if opening is slightly out of square. Top pivot and guide must be kept parallel with track. Track also available in white.

**1738**

**ORDERING DATA**

Specify	Opening Size	Lbs./Case Qty
	24" 2 Door	(Bulk only)
	30" 2 Door	packed 25
1734=3/4"	36" 2 Door	per carton)
1718=1 1/8"	48" 4 Door	
1738=1 3/8"	60" 4 Door	(Bulk only)
	72" 4 Door	packed 25
	96" 4 Door	per carton)

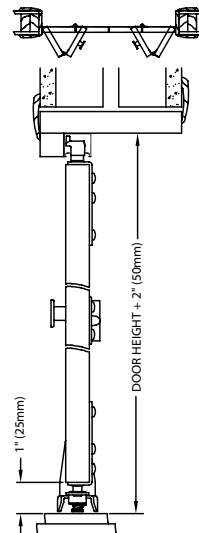

**2 Door Hardware Set Shown**



Same features as 1718/1734/1738 but for 3/4" doors only. Pivot and guide plate are 1/4" longer than 1718/1734/1738 plates. Track also available in white.

**1770**

**ORDERING DATA**

Item No.	Opening Size	Lbs./Case Qty
1770243H	24" 2 Door	(Bulk only)
1770303H	30" 2 Door	packed 25
1770363H	36" 2 Door	per carton)
1770486H	48" 4 Door	
1770606H	60" 4 Door	(Bulk only)
1770726H	72" 4 Door	packed 25
1770966H	96" 4 Door	per carton)

# 1825 Tap-In Bifold Hardware (7/16" pin) for 1 1/8" to 1 3/4" Thick Panels to 35 lbs.



## ORDERING DATA

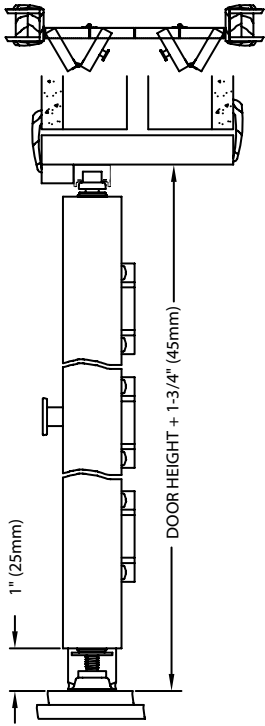

Item No.	Opening Size	Lbs./Case Qty
1825243H	24" 2 Door	(Bulk only)
1825303H	30" 2 Door	packed 25
1825323H	32" 2 Door	per carton)
1825363H	36" 2 Door	8/5
1825486H	48" 4 Door	12/5
1825606H	60" 4 Door	13/5
1825726H	72" 4 Door	15/5
1825966H	96" 4 Door	17/5

### 2 Door Components

Qty	Part #
1	1825 Track
1	1810 Pivot
1	1713 Snubber
1	1811 Jamb Brkt
1	1807 Bot Piv
3	1805 Hinges
1	33 Knob
2	1801 Top Guide
1	1712 Wrench

### 4 Door Components

Qty	Part #
1	1825 Track
2	1810 Pivot Lock
2	1713 Snubber
2	1811 Jamb Brkt
2	1807 Bot Piv
6	1805 Hinges
2	33 Knob
4	1801 Top Guide
1	1712 Wrench
1	1808 Aligner



### 4 Door Hardware Set Shown



## 1825

Low profile woodtone steel track. Pivots and guides have a needle bearing surface to minimize friction. Jamb bracket has an adjustable bottom pivot bearing socket. Hinges are self locating and automatically align to door. Brass-tone steel parts.

# 1838 Tap-In Bifold Hardware (3/8" pin) for 1 1/8" to 1 3/4" Thick Panels to 30 lbs.



## ORDERING DATA

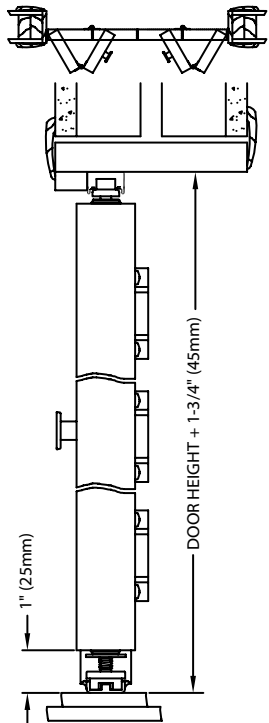

Item No.	Opening Size	Lbs./Case Qty
1838243H	24" 2 Door	(Bulk only)
1838303H	30" 2 Door	packed 25
1838323H	32" 2 Door	per carton)
1838363H	36" 2 Door	
1838486H	48" 4 Door	(Bulk only)
1838606H	60" 4 Door	packed 25
1838726H	72" 4 Door	per carton)
1838966H	96" 4 Door	

### 2 Door Components

Qty	Part #
1	1825 Track
1	1810 Pivot
1	1812 Snubber
1	1861 Jamb Brkt
1	1837 Bot Piv
3	1805 Hinges
1	37 Knob
2	1831 Top Guide
1	1712 Wrench

### 4 Door Components

Qty	Part #
1	1825 Track
2	1810 Pivot
1	1814 Snubber
2	1861 Jamb Brkt
2	1837 Bot Piv
6	1805 Hinges
2	37 Knob
4	1831 Top Guide
1	1712 Wrench
1	1808 Aligner



### 4 Door Hardware Set Shown



## 1838

Low profile white steel track. Pivots and guides have a needle bearing surface to minimize friction. Jamb bracket has positive positioning bottom pivot bearing socket. Hinges are self locating and automatically align to door. Brass-tone steel parts.

**ORDERING DATA**

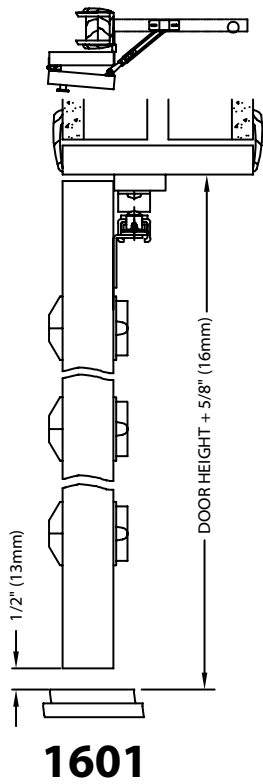

Item No.	Opening Size	Lbs./Case Qty
1601912P	18"-24" 2 Door	(Bulk only packed 25/Case)
1601218P	24"-36" 2 Door	8/5
1601824P	36"-48" 2 Door	10/5
For 4 Door Openings, Order 2 Kits and Double the Opening Size		

Package Components	
Qty	Part #
1	1601 Control Arm
1	1513 Bumper
1/2	1808 Aligner
3	1605 Hinge/Woodtone
3	1703 Hinges
1	33 Knob

Retail Box



2 Door Hardware Set Shown



Unique bifold provides full jamb to jamb access. Doors fold 180 degrees and lay flat against the wall. No top track. Comes with woodtone, non-mortise, lift off, jamb hinges (mortised hinges can be used at jamb). Woodtone Control Arm, brass-tone steel parts. White, non-mortise, lift off, jamb hinges are available in bulk.

**ORDERING DATA**

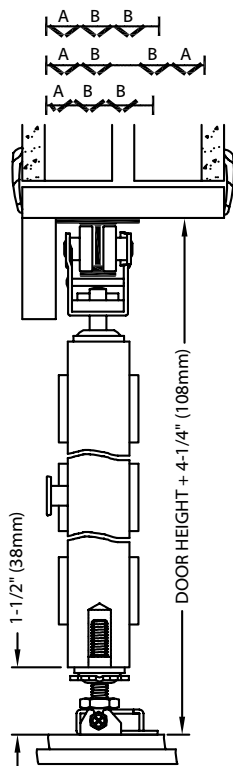

Specify	Description	Lbs./Case Qty
200	Track Only	See Page 30 For Sizes
2015BS-A	Basic Set (1st Pair of Doors)	3/1
2002PLBG	Add-On Set B (2nd and 3rd Pair)	28/25
2003 Hinge (Pair)	3.5"X3.5" Mortised Hinges	9/10 Pair

2015BS-A Components

Qty	Part #
1	2001 Top Pivot
1	2010 Pivot Lock
1	2002 Door Guide
1	2007 Bottom Pivot
1	2011 Pivot Bracket
1	37 Knob
1	1712 Wrench
Hinges Not Included Buy Mortised Hinges Separately	

2002PLBG Set B Components

Qty	Part #
1	2002 Door Guide
Hinges Not Included Buy Mortised Hinges Separately	



2015BS-A Components



2002PLBG Set B Components

Hardware for panels 12"-36" up to 9'0" high. Heavy duty I-beam track with positive pivot-lock, top hung, four wheel (1" dia.) ball bearing hangers, heavy duty bottom pivot, floor bracket with screw adjusting bottom pivot socket. Plated steel parts.

(Maximum: Six panels each way.)  
2003 Hinges must be ordered separately.





**ORDERING DATA**

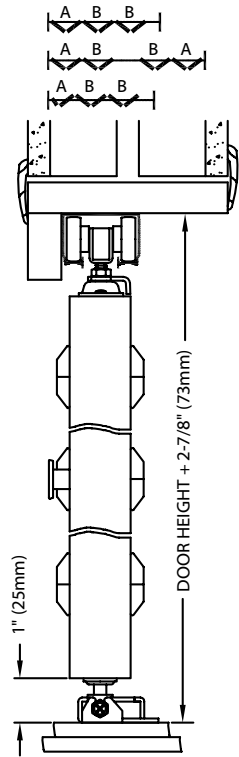

Specify	Description	Lbs./Case Qty
100	Track Only	See Page 30 For Sizes
1015BS-A	Basic Set (1st Pair of Doors)	1.5/1
1030AOSB	Add-On Set B (2nd and 3rd Pair)	1.4/1

**1015BS-A Components**

Qty	Part #
1	1001 Top Pivot
1	1010 Pivot Lock
1	1125 Door Guide
1	1706 Bottom Pivot
1	1011 Pivot Bracket
3	1606 Hinges
1	1155 Track Stop
1	33 Knob
1	1712 Wrench

**1030AOSB Components**

Qty	Part #
1	1125 Door Guide
6	1606 Hinges
1	33 Knob
1	1712 Wrench



**1015BS-A Components**



**1030AOSB Components**



Hardware for panels 12"-24" up to 9'0" high. Convex rail aluminum track with positive pivot lock, top hung, three wheel (1" dia.) ball bearing hangers, non-mortise lift off hinges. Floor bracket has a screw for adjusting bottom pivot socket. Brass-tone steel parts.

(Maximum: Six panels each way.)

**100RD**

**ORDERING DATA**

**ORDERING DATA**

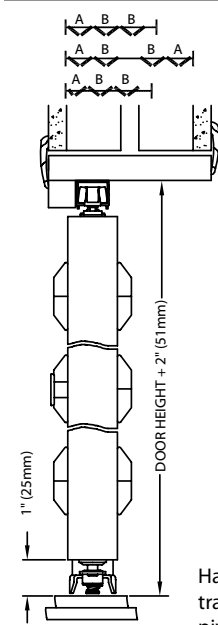

**1715BS-A Components**

Qty	Part #
1	1701 Top Pivot
1	1710 Pivot Lock
1	1742 Door Guide
1	1707 Bot. Pivot
1	1711 Piv. Bracket
3	1606 Hinges
1	1713 Track Stop
1	33 Knob
1	1712 Wrench

**1725AOSB Components**

Qty	Part #
6	1606 Hinges
1	1742 Door Guide
1	33 Knob



**1715BS-A Components**



**1725AOSB Components**



Hardware for panels 9" to 18" up to 6'8" high. Aluminum track with positive pivot lock, top hung, surface mounted pivots/hangers, four way adjustable jamb bracket, four wheel (7/16" dia.) hanger, non-mortise lift off hinges. Brass-tone steel parts. (Maximum: Six panels each way.)

Specify	Description	Lbs./Case Qty
170A	Track Only	See Page 30 For Sizes
1715BS-A	Basic Set (1st Pair of Doors)	1/1
1725AOSB	Add-On Set B (2nd and 3rd Pair)	1.2/1

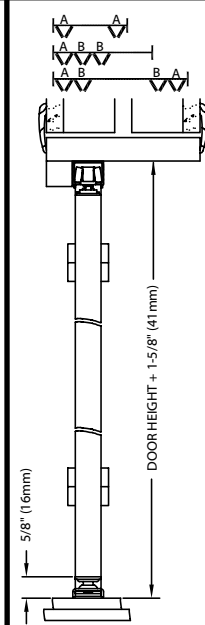

**1740BS-A Components**

Qty	Part #
1	1701 Top Pivot
1	1710 Pivot Lock
1	1742 Door Guide
1	1707 Bot. Pivot
1	1711 Piv. Bracket
2	1743 Hinges
1	1713 Track Stop
1	33 Knob
1	1712 Wrench

**1740-AOS Components**

Qty	Part #
4	1743 Hinges
1	1742 Door Guide
1	33 Knob



**1740BS-A Components**



**1740-AOS Components**



Hardware for panels 9" to 18" up to 6'8" high. Aluminum track with positive pivot lock, top hung, surface mounted pivots/hangers, four way adjustable jamb bracket, four wheel (7/16" dia.) hanger, non-mortise lift off hinges. Brass-tone steel parts. (Maximum: Six panels each way.)

Specify	Description	Lbs./Case Qty
170A	Track Only	See Page 30 For Sizes
1740BS-A	Basic Set (1st Pair of Doors)	5.5/10
1740-AOS	Add-On Set B (2nd and 3rd Pair)	2.4/10

**1740RD**



# 200WM Wall Mounted Track and Hardware for a minimum 1 1/8" or Thicker Door to 400 lbs.



## ORDERING DATA

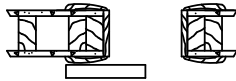

Item No.	Max Door Size	Lbs./Case Qty
200WM481	One 2'0" Door	7/1
200WM601	One 2'6" Door	8/1
200WM721	One 3'0" Door	9/1
200WM961	One 4'0" Door	11/1

200WM Hardware Set

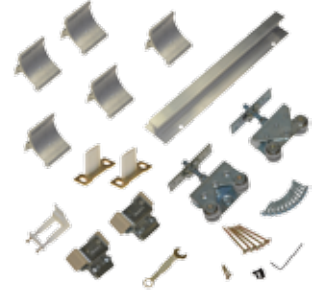

200WM Components

Qty	Part #	Qty	Part #
1	200 Track	1	12 Door Guide
4-6	2006 Brackets	2	2030 Guides
2	2020 Hangers	1	1712 Wrench
2	2055 Trk Stops	1	3/32" Wrench

### Bronze and Satin Anodized Fascia Available



Item No.	Max Door Size	Lbs./Case Qty
200W*048	One 4'0" Fascia	5/1
200W*060	One 5'0" Fascia	6/1
200W*072	One 6'0" Fascia	7/1
200W*096	One 8'0" Fascia	9/1

Snap-on Fascia sold separately and in sizes up to 192"

\*Add "S" to Item # for Satin, "B" for Bronze

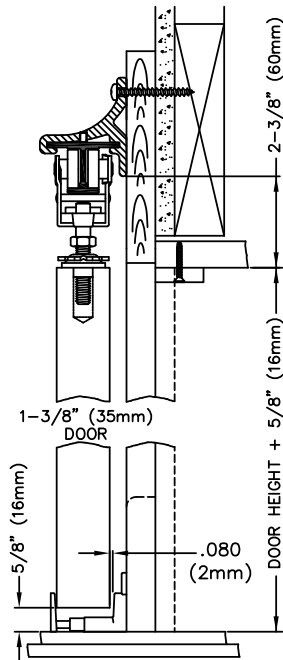

## 200WM

A unique surface mounted hardware set for open pocket doors. Use to slide door along the wall rather than in the wall. Features a heavy duty I-beam track, extruded aluminum wall mounting brackets to anchor the track to the wall studs, four wheel (1" dia.), smooth operating, ball bearing hangers, and two different guides to stabilize the door. Plated steel parts. Tracks available up to 192".

# 2610F Wall Mounted Fascia Track and Hardware for a 1" to 1 3/4" Thick Door to 125 lbs. (HD 200 lbs. w/ 1125 Hanger)



## ORDERING DATA

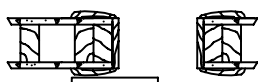

Item No.	Max Door Size	Lbs./Case Qty
2610F481	One 2'0" Door	21/4
2610F601	One 2'6" Door	25/4
2610F721	One 3'0" Door	30/4
2610F961	One 4'0" Door	42/5

A unique surface mounted hardware set for open pocket doors. Use to slide a door along the wall rather than in the wall. Aluminum track with convex rails, jump proof three wheel (1" dia.) hangers assure a smooth quiet operation. Also includes a wall-mounted door guide. Brass-tone steel parts. Single Pack Heavy Duty (HD) version includes the #1125 hanger for doors up to 200 lbs. Single Pack Heavy Duty Soft-Close/Open version includes two 1060 Soft Close Hangers for doors up to 200 lbs. and the ability to soft-close/open in both directions.



2610F Hardware Set

2610F Set Components

Qty	Part #
1	2610F Track
2	1120 Hangers
2	1155 Trk Stops
1	12 Guide
2	2680 End Caps
1	1712 Wrench

### Also Available in Dark Bronze/200 lbs. Rating



Item No.	Max Door Size	Lbs./Case Qty
2610F48B	One 2'0" Door	5/1
2610F60B	One 2'6" Door	6/1
2610F72B	One 3'0" Door	7/1
2610F96B	One 4'0" Door	9/1

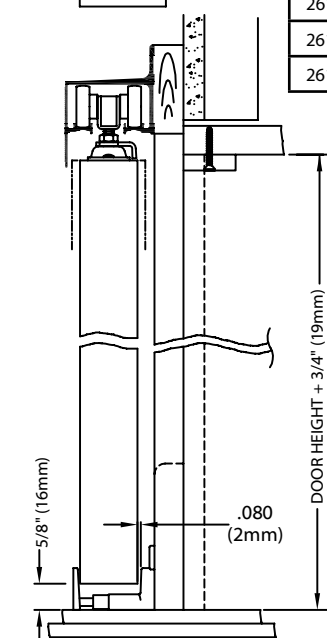
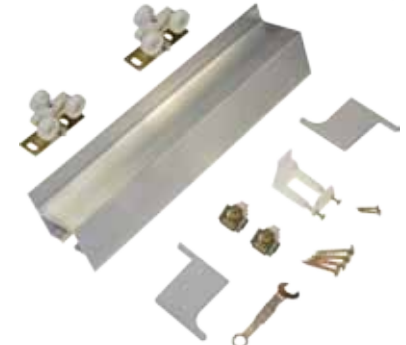

## 2610F

◀ **SOFT-Close/Open** ▶  
Compatible

# 2000 Commercial Grade Pocket Door Frame for 1 1/8" to 1 3/4" Thick Doors to 400 lbs.



## ORDERING DATA

For 2 x 4 construction. Aluminum 1" Beam track, smooth quiet operation, rust resistant steel reinforced wood split studs, jump proof 4 wheel ball bearing (1" dia.) hangers, self-adjusting floor anchors, 2'6" and 3'0" headers marked to cut to smaller door sizes. Plated steel parts.

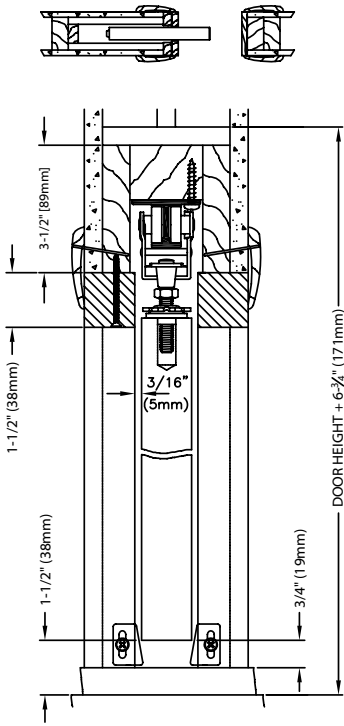

**2000**

## 2000 Series Pocket Door Frame Prices

Note: Frames marked with an \* will ship **COMMON CARRIER**

Item No.	Max Door Size	lbs/Case
<b>Frames for 80" Tall Doors</b>		
202668PF	For Doors up to 30" wide x 80" tall	42/1
203068PF	For Doors up to 36" wide x 80" tall	44/1
204068PF	For Doors up to 48" wide x 80" tall	63/1
*205068PF*	For Doors up to 60" wide x 80" tall	81/1
<b>Frames for 84" Tall Doors</b>		
202670PF	For Doors up to 30" wide x 84" tall	43/1
203070PF	For Doors up to 36" wide x 84" tall	45/1
204070PF	For Doors up to 48" wide x 84" tall	65/1
*205070PF*	For Doors up to 60" wide x 84" tall	83/1
<b>Frames for 96" Tall Doors</b>		
202680PF	For Doors up to 30" wide x 96" tall	47/1
203080PF	For Doors up to 36" wide x 96" tall	49/1
204080PF	For Doors up to 48" wide x 96" tall	70/1
*205080PF*	For Doors up to 60" wide x 96" tall	90/1
<b>Frames for 108" Tall Doors</b>		
*202690PF*	For Doors up to 30" wide x 108" tall	50/1
*203090PF*	For Doors up to 36" wide x 108" tall	52/1
*204090PF*	For Doors up to 48" wide x 108" tall	75/1
*205090PF*	For Doors up to 60" wide x 108" tall	97/1
<b>Accessories</b>		
2050PLBG	Converging Door Kit	10/10
2041PLBG	Hidden Guide Set	1.7/10

# 2060 Commercial Grade Pocket Door Frame for 1 1/8" to 2 1/4" Thick Doors to 400 lbs. (2" x 6" Stud Wall)



## ORDERING DATA

For 2 x 6 Construction. Heavy duty pocket door frame featuring heavy gauge all steel split studs for maximum wall rigidity. New all steel split stud design makes a pocket door wall sheeted with standard wall board material comparable in stiffness to standard non pocket door stud walls and eliminates warpage. The 2060 is designed like the rest of our pocket door frames so it can be used for single or converging pocket door applications. The 2060 is packaged for easy transport and fast installation in standard 2 X 6 timber or steel framed stud walls. Versatile frames can be adapted for use in thicker walls, block walls and cut down to accept any smaller door size.

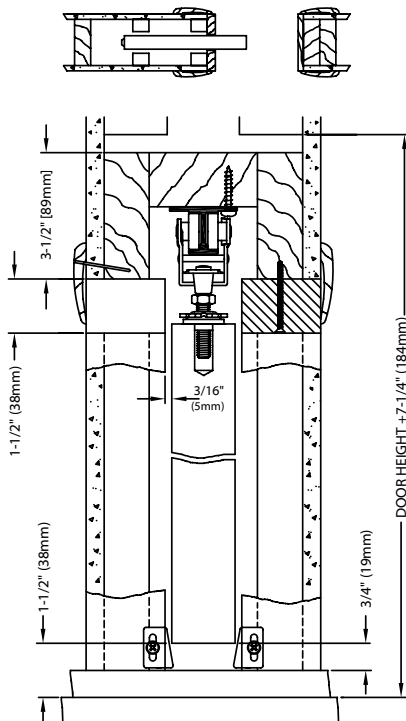

**2060**

## 2060 Series Pocket Door Frame Prices

Note: Frames marked with an \* will ship **COMMON CARRIER**

Item No.	Max Door Size	lbs/Case
<b>Frames for 80" Tall Doors</b>		
20602668	For Doors up to 30" wide x 80" tall	52/1
20603068	For Doors up to 36" wide x 80" tall	55/1
20604068	For Doors up to 48" wide x 80" tall	78/1
*20605068*	For Doors up to 60" wide x 80" tall	99/1
<b>Frames for 84" Tall Doors</b>		
20602670	For Doors up to 30" wide x 84" tall	53/1
20603070	For Doors up to 36" wide x 84" tall	56/1
20604070	For Doors up to 48" wide x 84" tall	80/1
*20605070*	For Doors up to 60" wide x 84" tall	102/1
<b>Frames for 96" Tall Doors</b>		
20602680	For Doors up to 30" wide x 96" tall	58/1
20603080	For Doors up to 36" wide x 96" tall	61/1
20604080	For Doors up to 48" wide x 96" tall	87/1
*20605080*	For Doors up to 60" wide x 96" tall	111/1
<b>Frames for 108" Tall Doors</b>		
*20602690*	For Doors up to 30" wide x 108" tall	62/1
*20603090*	For Doors up to 36" wide x 108" tall	65/1
*20604090*	For Doors up to 48" wide x 108" tall	94/1
*20605090*	For Doors up to 60" wide x 108" tall	120/1
<b>Accessory</b>		
2050PLBG	Converging Door Kit	10/10
2041PLBG	Hidden Guide Set	1.7/10

# 1500 Commercial Grade Pocket Door Frame for 1" to 1 3/8" Thick Doors (1 3/4" with 1575 Adaptor Kit) to 125 lbs. (200 lbs. with 1125 Hanger)



## ORDERING DATA

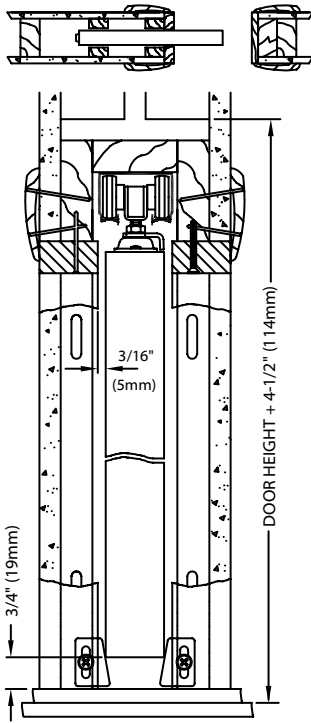

For 2 x 4 Construction. Removable aluminum track with convex rails for smooth quiet operation, rust resistant steel reinforced wood split studs, jump proof three wheel (1" dia.) hangers, self adjusting floor anchors, 2'6" and 3'0" headers marked to cut to smaller door sizes. Brass-tone steel parts. All frames for doors up to 1 3/8" can be converted for 1 3/4" doors with 1575PPK3 adaptor kit. All oversized frames include 1575PPK3 adaptor kit.



## 1500

Item No.	Description	lbs/Case
<b>Accessories</b>		
1500PPK3	Replacement Hardware Kit	5/10
1555PPK3	Converging Door Kit	6/10
1575PPK3	1 3/4" Door Adapter Kit	3/10
2041PLBG	Hidden Guide Set	1.7/10
<b>Steel Wrapped Uprights</b>		
Please Note: 3'6" and 4'0" Frames have 1 extra pair of uprights. 4'6" and 5'0" Frames have 2 extra pairs of uprights.		
1568UPRT	80" Upright Pair with 1 3/8" Floor Bracket	72/6
1570UPRT	84" Upright Pair with 1 3/8" Floor Bracket	75/6
1580UPRT	96" Upright Pair with 1 3/8" Floor Bracket	86/6
*1590UPRT*	108" Upright Pair with 1 3/8" Floor Bracket	96/6
<b>Hangers</b>		
1120	Standard Hanger, max weight 125 lbs.	13/50
1125	Ball-Bearing Hanger, max weight 200 lbs.	23/50
1060	Single Soft Close Hanger	1/1
1060SOFT	Soft Close Hanger and 1125 Hanger	6.7/5
1121	Hanger Plate w/ screws	9/100

## 1500 Series Pocket Door Frame Prices

Item No.	Max Door Size	lbs/Case
<b>Frames for 80" Tall Doors up to 125 lbs.</b>		
152068PF	For Doors up to 24" wide x 80" tall x 1 3/8"	28/1
152468PF	For Doors up to 28" wide x 80" tall x 1 3/8"	29/1
152668PF	For Doors up to 30" wide x 80" tall x 1 3/8"	30/1
152868PF	For Doors up to 32" wide x 80" tall x 1 3/8"	30/1
153068PF	For Doors up to 36" wide x 80" tall x 1 3/8"	30/1
<b>Frames for 80" Tall Doors up to 200 lbs. (Uses 1125 Ball Bearing Hanger)</b>		
152068HD	For Doors up to 24" wide x 80" tall x 1 3/8"	28/1
152468HD	For Doors up to 28" wide x 80" tall x 1 3/8"	29/1
152668HD	For Doors up to 30" wide x 80" tall x 1 3/8"	30/1
152868HD	For Doors up to 32" wide x 80" tall x 1 3/8"	30/1
153068HD	For Doors up to 36" wide x 80" tall x 1 3/8"	30/1
<b>Soft Close Frames for 80" Tall Doors up to 200 lbs. (Uses 1060 Soft Closers)</b>		
153068SC	For Doors up to 36" wide x 80" tall x 1 3/8"	30/1
<b>Frames Below include 1575 1 3/4" Adaptor Kit (Uses 1125 Ball Bearing Hanger)</b>		
153668PF	For Doors up to 42" wide x 80" tall x 1 3/4"	40/1
154068PF	For Doors up to 48" wide x 80" tall x 1 3/4"	42/1
*154668PF*	For Doors up to 54" wide x 80" tall x 1 3/4"	54/1
*155068PF*	For Doors up to 60" wide x 80" tall x 1 3/4"	55/1
<b>Frames for 84" Tall Doors up to 200 lbs. (Uses 1125 Ball Bearing Hanger)</b>		
152070PF	For Doors up to 24" wide x 84" tall x 1 3/4"	32/1
152470PF	For Doors up to 28" wide x 84" tall x 1 3/4"	34/1
152670PF	For Doors up to 30" wide x 84" tall x 1 3/4"	35/1
152870PF	For Doors up to 32" wide x 84" tall x 1 3/4"	37/1
153070PF	For Doors up to 36" wide x 84" tall x 1 3/4"	39/1
153670PF	For Doors up to 42" wide x 84" tall x 1 3/4"	43/1
154070PF	For Doors up to 48" wide x 84" tall x 1 3/4"	50/1
*154670PF*	For Doors up to 54" wide x 84" tall x 1 3/4"	57/1
*155070PF*	For Doors up to 60" wide x 84" tall x 1 3/4"	61/1
<b>Frames for 96" Tall Doors up to 200 lbs. (Uses 1125 Ball Bearing Hanger)</b>		
152080PF	For Doors up to 24" wide x 96" tall x 1 3/4"	35/1
152480PF	For Doors up to 28" wide x 96" tall x 1 3/4"	39/1
152680PF	For Doors up to 30" wide x 96" tall x 1 3/4"	40/1
152880PF	For Doors up to 32" wide x 96" tall x 1 3/4"	41/1
153080PF	For Doors up to 36" wide x 96" tall x 1 3/4"	43/1
153680PF	For Doors up to 42" wide x 96" tall x 1 3/4"	44/1
154080PF	For Doors up to 48" wide x 96" tall x 1 3/4"	50/1
*154680PF*	For Doors up to 54" wide x 96" tall x 1 3/4"	59/1
*155080PF*	For Doors up to 60" wide x 96" tall x 1 3/4"	62/1
<b>Frames for 108" Tall Doors up to 200 lbs. (Uses 1125 Ball Bearing Hanger)</b>		
*152090PF*	For Doors up to 24" wide x 108" tall x 1 3/4"	38/1
*152490PF*	For Doors up to 28" wide x 108" tall x 1 3/4"	40/1
*152690PF*	For Doors up to 30" wide x 108" tall x 1 3/4"	41/1
*152890PF*	For Doors up to 32" wide x 108" tall x 1 3/4"	42/1
*153090PF*	For Doors up to 36" wide x 108" tall x 1 3/4"	44/1
*153690PF*	For Doors up to 42" wide x 108" tall x 1 3/4"	56/1
*154090PF*	For Doors up to 48" wide x 108" tall x 1 3/4"	62/1
*154690PF*	For Doors up to 54" wide x 108" tall x 1 3/4"	72/1
*155090PF*	For Doors up to 60" wide x 108" tall x 1 3/4"	80/1

Note: Frames marked with an \* will ship **COMMON CARRIER**



Compatible

# 1500SC Soft Close and Open Commercial Grade Pocket Door Frame for 1" to 1 3/8" Thick Doors (1 3/4" with 1575 Adaptor Kit) to 200 lbs.



## ORDERING DATA

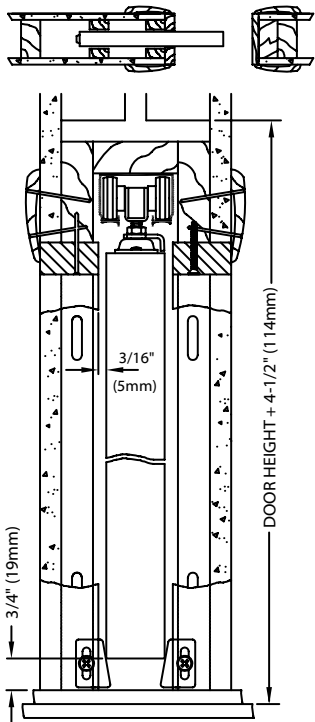

**1500SC**

For 2 x 4 Construction. Same features as the 1500 Series frame, but it includes two 1060 soft close assemblies to enable both soft close and soft open along with the smooth rolling of ball-bearing hangers. All frames for doors up to 1 3/8" can be converted for 1 3/4" doors with 1575PPK3 adaptor kit. All oversized frames include 1575PPK3 adaptor kit.



Item No.	Description	lbs/Case
<b>Accessories</b>		
1575PPK3	1 3/4" Door Adapter Kit	3/10
1555PPK3	Converging Door Kit	6/10
2041PLBG	Hidden Guide Set	1.7/10

## 1500 Series Pocket Door Frame Prices

Item No.	Max Door Size	lbs/Case
<b>Frames for 80" Tall Doors and up to 1 3/8" Thick (1575PPK3 available)</b>		
152468SC	For Doors up to 28" wide x 80" tall	30/1
152668SC	For Doors up to 30" wide x 80" tall	30/1
152868SC	For Doors up to 32" wide x 80" tall	30/1
153068SC	For Doors up to 36" wide x 80" tall	30/1
<b>Frames for 80" Tall Doors up to 1 3/4" Thick (1575PPK3 Included)</b>		
153668SC	For Doors up to 42" wide x 80" tall	40/1
154068SC	For Doors up to 48" wide x 80" tall	42/1
<b>Frames for 84" Tall Doors up to 1 3/4" Thick (1575PPK3 Included)</b>		
152470SC	For Doors up to 28" wide x 84" tall	34/1
152670SC	For Doors up to 30" wide x 84" tall	35/1
152870SC	For Doors up to 32" wide x 84" tall	37/1
153070SC	For Doors up to 36" wide x 84" tall	39/1
153670SC	For Doors up to 42" wide x 84" tall	43/1
154070SC	For Doors up to 48" wide x 84" tall	50/1
<b>Frames for 96" Tall Doors up to 1 3/4" Thick (1575PPK3 Included)</b>		
152480SC	For Doors up to 28" wide x 96" tall	39/1
152680SC	For Doors up to 30" wide x 96" tall	40/1
152880SC	For Doors up to 32" wide x 96" tall	41/1
153080SC	For Doors up to 36" wide x 96" tall	43/1
153680SC	For Doors up to 42" wide x 96" tall	44/1
154080SC	For Doors up to 48" wide x 96" tall	50/1

# 1060 Soft Close Assembly



## ORDERING DATA

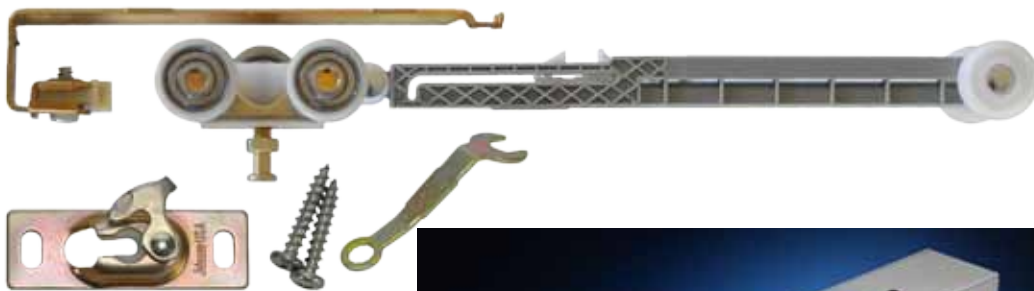

Item No.	Lbs./Case Qty
1060	1/1
1060SOFT	6.7/5



## SOFT-Close/Open

- Make your sliding doors Soft Close quietly and securely.
- Doors up to 200 lbs(91kg) are smoothly braked and pulled into the closed position.
- Use with new or existing Johnson Hardware Sliding and Pocket Door Hardware. Any sliding door track profile that uses the 1120/1125 hanger can utilize the 1060 Soft Close. Works with the following Hardware Series: 138F, 134F, 100PD, 100SD, 2610F, 1500, 1560, 1562, 2710
- Holds door securely in place, closed or open.
- Prevents door slamming or pinched fingers between door and jamb.
- Use 1 1060SOFT Set per door for "soft-close" OR "soft-open" when you are converting a setup previously using our 1120 standard bearing hangers. Use 1 1060 when converting a setup previously using our 1125 ball-bearing hangers. Minimum 24" (609mm) wide doors.
- Use 2 1060's per door for "soft-close" AND "soft-open". Pocket Doors Minimum 28" (711mm) wide doors. Bypass and Wall-Mount Minimum 24" (609mm) wide doors.

# 1560 Commercial Grade Pocket Door Frame for 1" to 3" Thick Doors to 200 lbs. (2" x 6" Stud Wall)



## ORDERING DATA

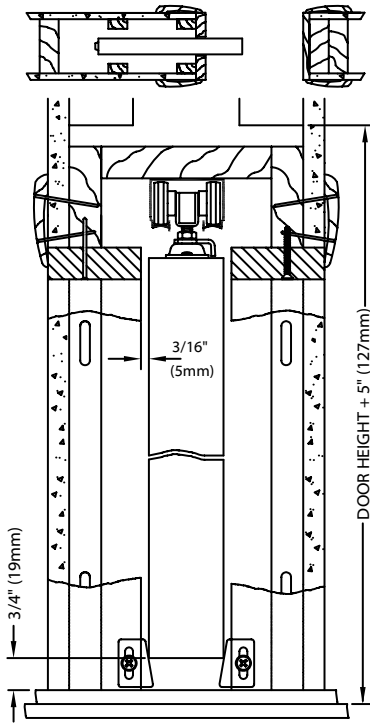

For 2 x 6 Construction. Removable aluminum track with convex rails, rust resistant steel reinforced wood split studs, jump proof three wheel (1" dia.) ball bearing hangers, self-adjusting floor anchors, headers marked to cut to smaller door sizes. Brass-tone steel parts.



**1560**

◀◀ **SOFT-Close/Open** ▶▶  
Compatible

## 1560 Series Pocket Door Frame Prices

Note: Frames marked with an \* will ship **COMMON CARRIER**

Item No.	Max Door Size	lbs/Case
<b>Frames for 80" Tall Doors</b>		
15602668	For Doors up to 30" wide x 80" tall	31/1
15603068	For Doors up to 36" wide x 80" tall	33/1
15604068	For Doors up to 48" wide x 80" tall	58/1
*15605068	For Doors up to 60" wide x 80" tall	73/1
<b>Frames for 84" Tall Doors</b>		
15602670	For Doors up to 30" wide x 84" tall	38/1
15603070	For Doors up to 36" wide x 84" tall	40/1
15604070	For Doors up to 48" wide x 84" tall	61/1
*15605070	For Doors up to 60" wide x 84" tall	77/1
<b>Frames for 96" Tall Doors</b>		
15602680	For Doors up to 30" wide x 96" tall	41/1
15603080	For Doors up to 36" wide x 96" tall	43/1
15604080	For Doors up to 48" wide x 96" tall	66/1
*15605080	For Doors up to 60" wide x 96" tall	85/1
<b>Frames for 108" Tall Doors</b>		
*15602690	For Doors up to 30" wide x 108" tall	45/1
*15603090	For Doors up to 36" wide x 108" tall	47/1
*15604090	For Doors up to 48" wide x 108" tall	71/1
*15605090	For Doors up to 60" wide x 108" tall	92/1
<b>Accessory</b>		
1555PPK3	Converging Door Kit	6/10
2041PLBG	Hidden Guide Set	1.7/10

# 1562 Commercial Grade Bypass Pocket Door Frame for 1 3/8" Thick Doors to 200 lbs. (2" x 6" Stud Wall)



## ORDERING DATA

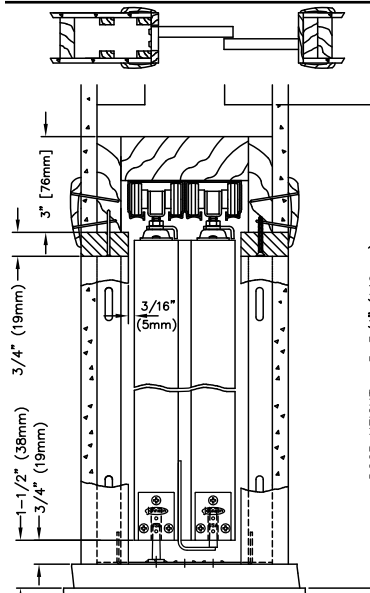

**1562**

◀◀ **SOFT-Close/Open** ▶▶  
Compatible

For 2 x 6 Construction. The 1562 Series Bypass Pocket Door Frame is designed to carry 2 bypassing doors up to 200 lbs. each in a standard 2 x 6 timber or steel framed stud wall. The 1562 allows architects and designers to specify large room dividing openings with minimum wall usage. The 1562 Frame Kit is factory configured to accept many standard door sizes and packaged for easy transport and fast installation in either bypass pocket door or converging bypass pocket door applications. This frame utilizes the 100PD Hardware Series and no bottom track is needed.

## 1562 Series Pocket Door Frame Prices

Note: Frames marked with an \* will ship **COMMON CARRIER**

Item No.	Max Door Size	lbs/Case
<b>Frames for 80" Tall Doors</b>		
15621668	Doors up to 18" x 80" For 36" Opening	46/1
15622068	Doors up to 24" x 80" For 48" Opening	50/1
15622668	Doors up to 30" x 80" For 60" Opening	56/1
*15623068	Doors up to 36" x 80" For 72" Opening	63/1
<b>Frames for 84" Tall Doors</b>		
15621670	Doors up to 18" x 84" For 36" Opening	47/1
15622070	Doors up to 24" x 84" For 48" Opening	51/1
15622670	Doors up to 30" x 84" For 60" Opening	57/1
*15623070	Doors up to 36" x 84" For 72" Opening	64/1
<b>Frames for 96" Tall Doors</b>		
15621680	Doors up to 18" x 96" For 36" Opening	50/1
15622080	Doors up to 24" x 96" For 48" Opening	54/1
15622680	Doors up to 30" x 96" For 60" Opening	61/1
*15623080	Doors up to 36" x 96" For 72" Opening	67/1
<b>Frames for 108" Tall Doors</b>		
*15621690	Doors up to 18" x 108" For 36" Opening	54/1
*15622090	Doors up to 24" x 108" For 48" Opening	58/1
*15622690	Doors up to 30" x 108" For 60" Opening	64/1
*15623090	Doors up to 36" x 108" For 72" Opening	71/1
<b>Accessory</b>		
1556PLBG	Converging Door Kit	6/10

# 2710 Fabricated Pocket Door Frame for 1" to 1 3/8" Thick Doors to 125 lbs. (200 lbs. with 1125 Hanger)



## ORDERING DATA

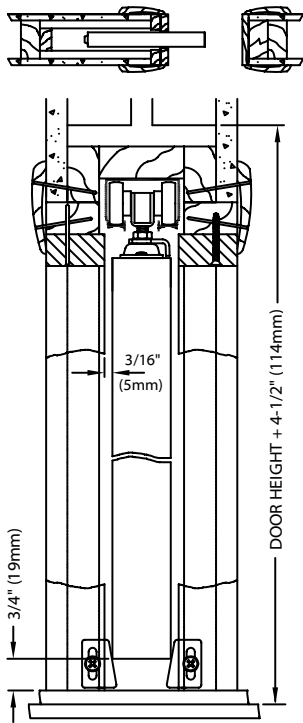

A "pre-assembled" pocket door frame with 10 horizontal members for 2" x 4" construction. Removable aluminum track with convex rails, jump proof three wheel (1" dia.) hangers. Brass-tone steel parts. *Optional hanger #1125 available for doors to 200 lbs.*

**Note: Minimum of 40 Frames on any one order**



### 2710

◀ **SOFT-Close/Open** ▶  
Compatible

Item No.	Description	lbs/Case
<b>Accessories</b>		
1500PPK3	Hardware Kit (125 lbs.)	5/10
1555PPK3	Converging Door Kit	6/10

## 2710 Series Pocket Door Frame Prices

Item No.	Max Door Size	lbs/Case
<b>Frames for 80" Tall Doors up to 125 lbs.</b>		
27102068	For Doors up to 24" wide x 80" tall x 1 1/8"	23/1
27102468	For Doors up to 28" wide x 80" tall x 1 1/8"	26/1
27102668	For Doors up to 30" wide x 80" tall x 1 1/8"	27/1
27102868	For Doors up to 32" wide x 80" tall x 1 1/8"	28/1
27103068	For Doors up to 36" wide x 80" tall x 1 1/8"	31/1
<b>Frames for 80" Tall Doors up to 200 lbs. (Uses 1125 Ball Bearing Hanger)</b>		
27H02068	For Doors up to 24" wide x 80" tall x 1 1/8"	23/1
27H02468	For Doors up to 28" wide x 80" tall x 1 1/8"	26/1
27H02668	For Doors up to 30" wide x 80" tall x 1 1/8"	27/1
27H02868	For Doors up to 32" wide x 80" tall x 1 1/8"	28/1
27H03068	For Doors up to 36" wide x 80" tall x 1 1/8"	31/1
<b>Frames for 84" Tall Doors up to 200 lbs. (Uses 1125 Ball Bearing Hanger)</b>		
27102070	For Doors up to 24" wide x 84" tall x 1 1/8"	30/1
27102470	For Doors up to 28" wide x 84" tall x 1 1/8"	33/1
27102670	For Doors up to 30" wide x 84" tall x 1 1/8"	34/1
27102870	For Doors up to 32" wide x 84" tall x 1 1/8"	38/1
27103070	For Doors up to 36" wide x 84" tall x 1 1/8"	39/1
<b>Frames for 96" Tall Doors up to 200 lbs. (Uses 1125 Ball Bearing Hanger)</b>		
27102080	For Doors up to 24" wide x 96" tall x 1 1/8"	38/1
27102480	For Doors up to 28" wide x 96" tall x 1 1/8"	42/1
27102680	For Doors up to 30" wide x 96" tall x 1 1/8"	43/1
27102880	For Doors up to 32" wide x 96" tall x 1 1/8"	47/1
27103080	For Doors up to 36" wide x 96" tall x 1 1/8"	48/1

# 2711 Fabricated Pocket Door Frame for 3/4" to 1 3/8" Thick Doors to 80 lbs. (150 lbs. with 1025 Hanger)



## ORDERING DATA

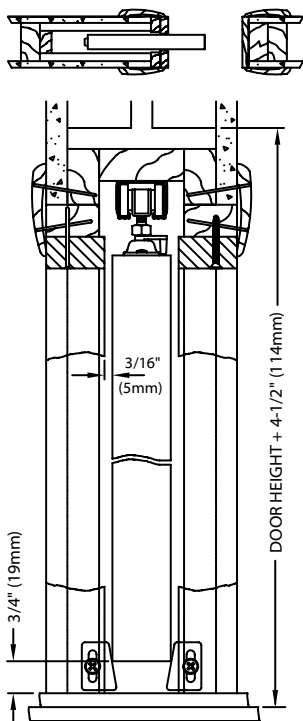

A "pre-assembled" pocket door frame with 10 horizontal members for 2" x 4" construction. Removable aluminum track with convex rails, jump proof three wheel (3/4" dia.) hangers. Brass-tone steel parts. *Optional hanger #1025 available for doors to 150 lbs.*



### 2711



## 2711 Series Pocket Door Frame Prices

**Note: Minimum of 40 Frames on any one order**

Item No.	Max Door Size	lbs/Case
<b>Frames for 80" Tall Doors up to 80 lbs.</b>		
27112068	For Doors up to 24" wide x 80" tall x 1 1/8"	23/1
27112468	For Doors up to 28" wide x 80" tall x 1 1/8"	26/1
27112668	For Doors up to 30" wide x 80" tall x 1 1/8"	27/1
27112868	For Doors up to 32" wide x 80" tall x 1 1/8"	28/1
27113068	For Doors up to 36" wide x 80" tall x 1 1/8"	31/1
<b>Frames for 80" Tall Doors up to 150 lbs. (Uses 1025 Ball Bearing Hanger)</b>		
27H12068	For Doors up to 24" wide x 80" tall x 1 1/8"	23/1
27H12468	For Doors up to 28" wide x 80" tall x 1 1/8"	26/1
27H12668	For Doors up to 30" wide x 80" tall x 1 1/8"	27/1
27H12868	For Doors up to 32" wide x 80" tall x 1 1/8"	28/1
27H13068	For Doors up to 36" wide x 80" tall x 1 1/8"	31/1
<b>Accessories</b>		
2511PPK3	Replacement Hardware Kit (80 lbs.)	3/10
1555PPK3	Converging Door Kit	6/10

**2511** Commercial Grade Pocket Door Frame for 3/4" to 1 3/8" Thick Doors  
(1 3/4" with 1575 Adaptor Kit) to 80 lbs. (150 lbs. with 1025 Hanger)



**ORDERING DATA**

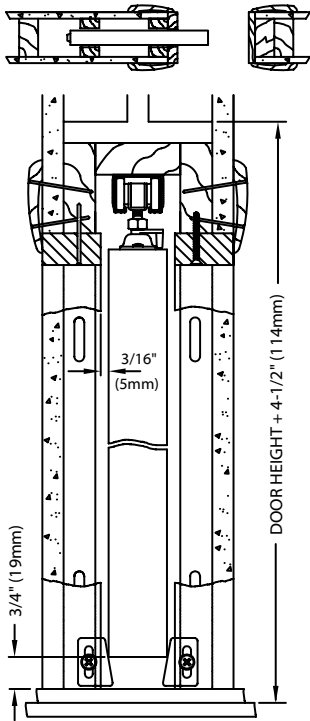

For 2 x 4 Construction. Removable aluminum track with convex rails for smooth quiet operation, rust resistant steel reinforced wood split studs, jump proof three wheel (3/4" dia.) hangers, self adjusting floor anchors, 2'6" and 3'0" headers marked to cut to smaller door sizes. Brass-tone steel parts. All frames for doors up to 1 3/8" can be converted for 1 3/4" doors with 1575PPK3 adaptor kit. Very similar to 1500 Series Frame, but with smaller diameter hanger.



**2511**

**2511 Series Pocket Door Frame Prices**

Item No.	Max Door Size	lbs/Case
<b>Frames for 80" Tall Doors up to 80 lbs.</b>		
25112668	For Doors up to 30" wide x 80" tall x 1 3/8"	27/1
25113068	For Doors up to 36" wide x 80" tall x 1 3/8"	29/1
<b>Frames for 80" Tall Doors up to 150 lbs. (Uses 1025 Ball Bearing Hanger)</b>		
252668HD	For Doors up to 30" wide x 80" tall x 1 3/8"	27/1
253068HD	For Doors up to 36" wide x 80" tall x 1 3/8"	29/1
<b>Accessories</b>		
2511PPK3	Hardware Replacement Set (80 lbs.)	4/10
1555PPK3	Converging Door Kit	6/10
1575PPK3	1-3/4" Door Adapter Kit	4/10
1025PLB2	Pair of Hangers for 150 lbs. Doors	4/10
2041PLBG	Hidden Guide Set	1.7/10



**1510** (Finger-Jointed, Primed/For Painting) Universal Pocket Door Jamb Kit  
**1511** (Clear Pine/For Staining) For 4 9/16" Thick Walls



**ORDERING DATA**

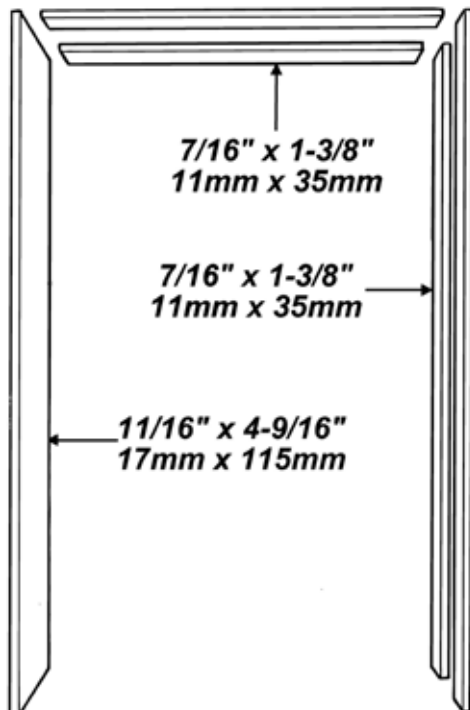

Item No.	Max Door Size	LBS/Case
15103068	3'0" x 6'8"	20/3
15113068	3'0" x 6'8"	20/3

A fast, convenient method of finishing a Pocket Door Installation. Just cut to length and install. No ripping of special thickness stock. Presanded so finishing is a snap.

Package includes 5 boards. Two split header boards, two split jamb boards, and a strike jamb board. (Since a wide variety of casings are available, they are not included)

Jamb can be cut down for smaller sized doors.

Cannot be used with the 2000 Series Frame..

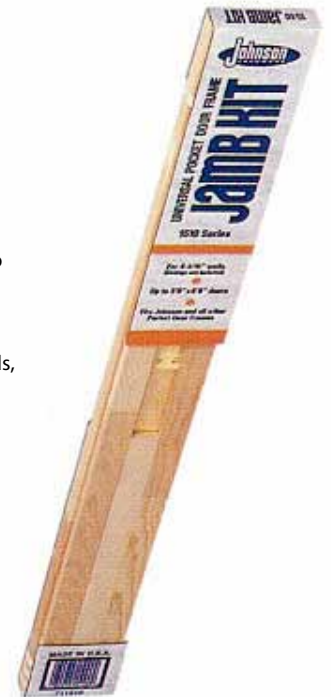

**1510/1511**



**ORDERING DATA**

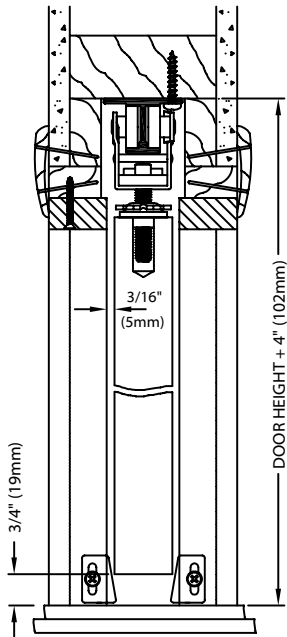
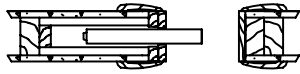

**200PD**

Item No.	Max Door Size	Lbs./Case
200481DR	One 2'0" Door	Bulk Only/
200601DR	One 2'6" Door	5/Case
200721DR	One 3'0" Door	7/1
200961DR	One 4'0" Door	9/1

200PD Components

Qty	Part #
1	200 Track
2	2020 Hangers
1	1550 Guides
1	1513 Bumper

A deluxe commercial grade hardware set. Can be used for pocket doors or in combination with itself to make special installations of sliding doors. Heavy duty I-beam aluminum track. Four wheel (1" dia.) ball bearing hangers. Plated steel parts. Tracks can be cut down for smaller applications.

200PD Hardware Set



**ORDERING DATA**

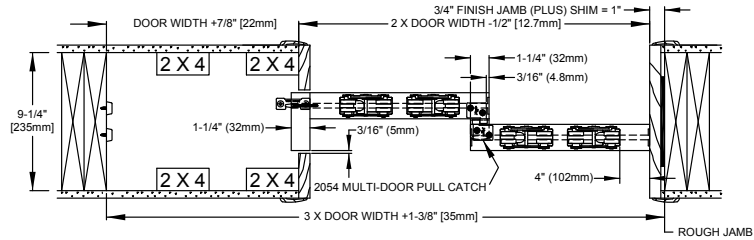
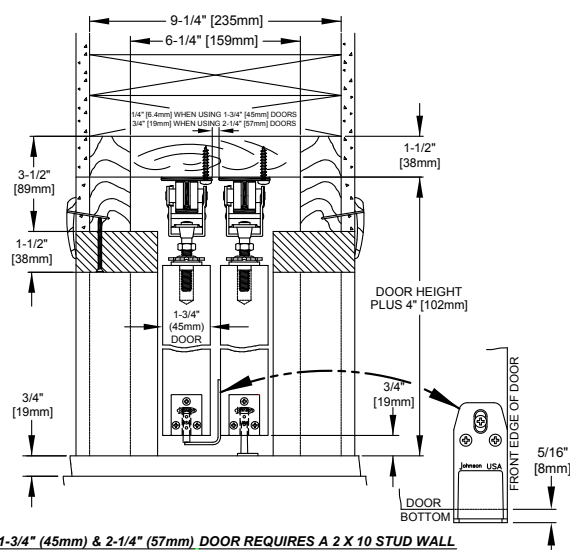

Item No.	Max Door Size	Lbs./Case
20BP0722	Two 2'0" Doors 1 3/4" Thick	Bulk Only
20BP0723	Two 2'0" Doors 2 1/4" Thick	5/Case
20BP0962	Two 2'8" Doors 1 3/4" Thick	Bulk Only
20BP0963	Two 2'8" Doors 2 1/4" Thick	5/Case
20BP1062	Two 3'0" Doors 1 3/4" Thick	Bulk Only
20BP1063	Two 3'0" Doors 2 1/4" Thick	5/Case
20BP1442	Two 4'0" Doors 1 3/4" Thick	Bulk Only
20BP1443	Two 4'0" Doors 2 1/4" Thick	5/Case

**200BP**

An extra heavy duty bypass commercial pocket door hardware set. This set can carry heavy duty solid core doors up to 400 lbs each. No bottom track required. It utilizes trackless guide posts that allow the doors to guide each other. The tracks are precision extruded heavy gauge aluminum I-beam track that will not allow the wheels to "jump" the track. It utilizes fully adjustable/removable door hangers for precision fit and finish. The wheels themselves have smooth rolling nylon exteriors with individually caged ball-bearings around the axle. This is quite simply our best line of hardware that we make.

For converging doors, 2 doors going right and 2 doors going left, meeting in the middle, just order two hardware sets. One for each side.





# 200MP Commercial Grade Multi-Pass Pocket Door Hardware for 1 3/4" or 2 1/4" Doors to 400 lbs./each



## ORDERING DATA

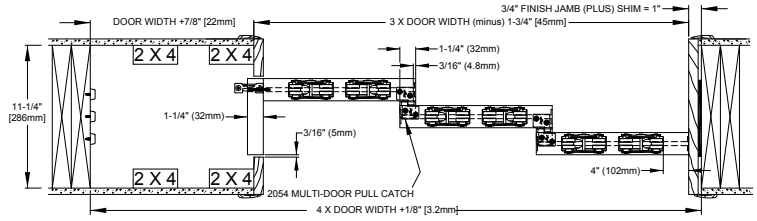
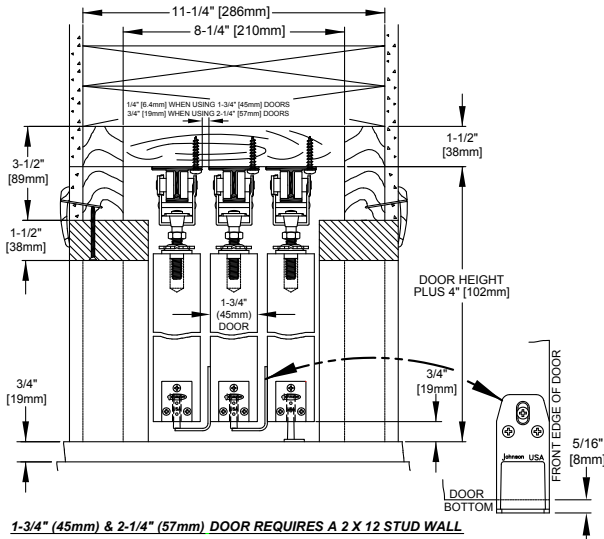

Item No.	Max Door Size	Lbs./Case
20MP0962	Three 2'0" Doors 1 3/4" Thick	Bulk Only
20MP0963	Three 2'0" Doors 2 1/4" Thick	5/Case
20MP1202	Three 2'6" Doors 1 3/4" Thick	Bulk Only
20MP1203	Three 2'6" Doors 2 1/4" Thick	5/Case
20MP1442	Three 3'0" Doors 1 3/4" Thick	Bulk Only
20MP1443	Three 3'0" Doors 2 1/4" Thick	5/Case
20MP1922	Three 4'0" Doors 1 3/4" Thick	Bulk Only
20MP1923	Three 4'0" Doors 2 1/4" Thick	5/Case

## 200MP

An extra heavy duty multi-pass commercial pocket door hardware set. Similar to the 200BP, but with enough hardware to carry three doors. This can carry heavy duty solid core doors up to 400 lbs each. No bottom track required. It utilizes trackless guide posts allowing the doors guide each other. The tracks are precision extruded heavy gauge aluminum I-beam track that will not allow the wheels to "jump" the track. It utilizes fully adjustable/removable door hangers for precision fit and finish. The wheels themselves have smooth rolling nylon exteriors with individually caged ball-bearings around the axle. This is quite simply our best line of hardware that we make.

For converging doors, 3 doors going right and 3 doors going left, meeting in the middle, just order two hardware sets. One for each side.



# 100PD Commercial Grade Pocket Door Hardware for a 1" or Thicker Door to 125 lbs. (200 lbs. with 1125 Hangers)



## ORDERING DATA

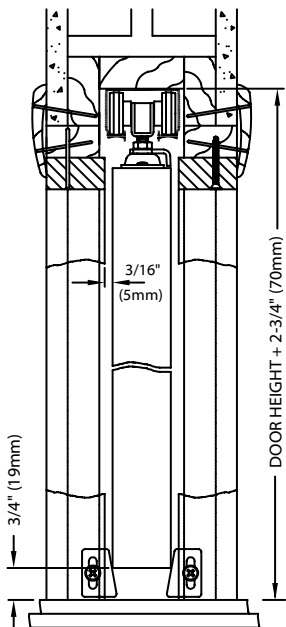
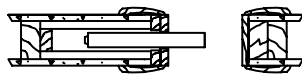

Item No.	Max Door Size	Lbs./Case
100481DR	One 2'0" Door	12/5
100601DR	One 2'6" Door	14/5
100721DR	One 3'0" Door	16/5
100961DR	One 4'0" Door	20/5

### 100PD Components

Qty	Part #
1	100 Track
2	1120 Hangers
1	1550 Guides
1	1513 Bumper
1	1712 Wrench

Can be used for pocket doors or in combination with itself to make special installations of sliding doors. Aluminum track with convex rails, jump proof three wheel (1" dia.) hangers assure a smooth, quiet operation. Brass-tone steel parts. Tracks can be cut down for smaller applications. *Optional Hanger #1125 available for doors up to 200 lbs.*

### 100PD Hardware Set

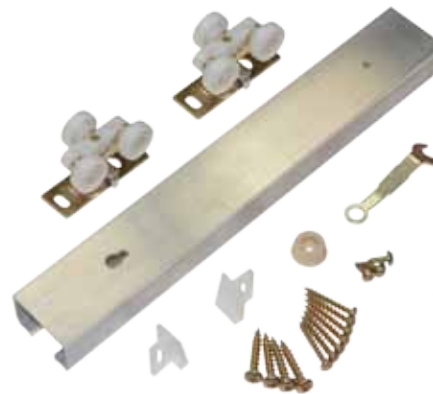

## 100PD



Compatible

# 100BP Commercial Grade Bypass Pocket Door Hardware for 1 3/8", 1 3/4", or 2 1/4" Doors to 200 lbs./each



## ORDERING DATA

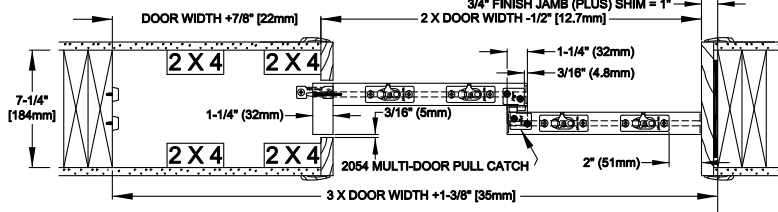
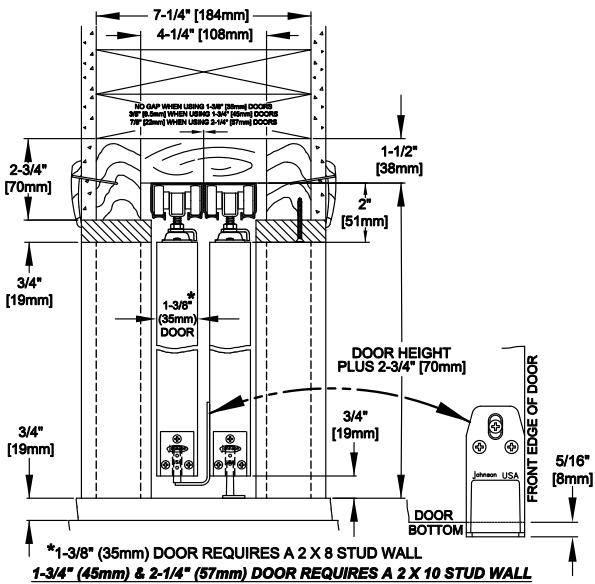

Item No.	Max Door Size	Lbs./Case
10BP0721	Two 2'0" Doors 1 3/8" Thick	Bulk Only
10BP0722	Two 2'0" Doors 1 3/4" Thick	5/Case
10BP0961	Two 2'8" Doors 1 3/8" Thick	Bulk Only
10BP0962	Two 2'8" Doors 1 3/4" Thick	5/Case
10BP1061	Two 3'0" Doors 1 3/8" Thick	Bulk Only
10BP1062	Two 3'0" Doors 1 3/4" Thick	5/Case
10BP1441	Two 4'0" Doors 1 3/8" Thick	Bulk Only
10BP1442	Two 4'0" Doors 1 3/4" Thick	5/Case

\*\*\*Sets for 2 1/4" Thick Doors Also Available\*\*\*

### 100BP



Compatible

A commercial grade bypass pocket door hardware set that can carry heavy doors up to 200 lbs. per door. No bottom track required. It utilizes trackless guide posts allowing the doors to guide each other. The set includes precision extruded aluminum "Jump Proof" box tracks. They use fully adjustable and removable door hangers for precision fit and finish. The hangers utilize three wheel, nylon encapsulated ball bearing hangers for a quiet and smooth roll.

For converging doors, 2 doors going right and 2 doors going left, meeting in the middle, just order two hardware sets. One for each side.



# 100MP Commercial Grade Multi Pass Pocket Door Hardware for 1 3/8", 1 3/4", or 2 1/4" Doors to 200 lbs./each



## ORDERING DATA

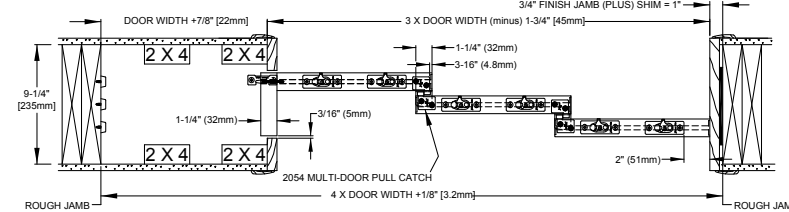
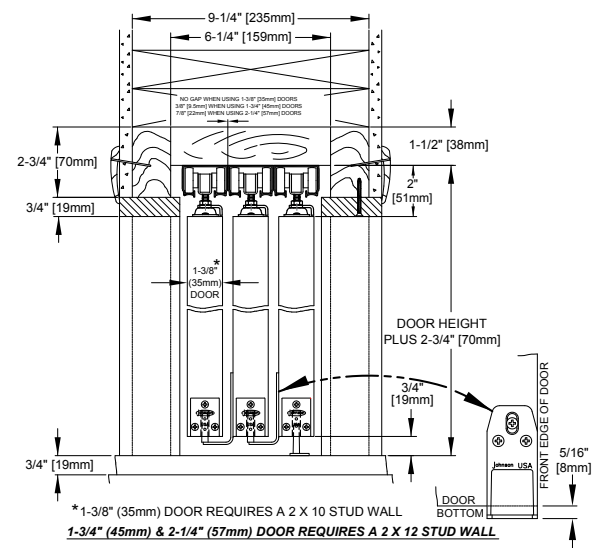

Item No.	Max Door Size	Lbs./Case
10MP0961	Three 2'0" Doors 1 3/8" Thick	Bulk Only
10MP0962	Three 2'0" Doors 1 3/4" Thick	5/Case
10MP1201	Three 2'6" Doors 1 3/8" Thick	Bulk Only
10MP1202	Three 2'6" Doors 1 3/4" Thick	5/Case
10MP1441	Three 3'0" Doors 1 3/8" Thick	Bulk Only
10MP1442	Three 3'0" Doors 1 3/4" Thick	5/Case
10MP1921	Three 4'0" Doors 1 3/8" Thick	Bulk Only
10MP1922	Three 4'0" Doors 1 3/4" Thick	5/Case

\*\*\*Sets for 2 1/4" Thick Doors Also Available\*\*\*

### 100MP



Compatible

A commercial grade multi pass pocket door hardware set that can carry heavy doors up to 200 lbs. per door. No bottom track required. It utilizes trackless guide posts allowing the doors to guide each other. The set includes precision extruded aluminum "Jump Proof" box tracks. They use fully adjustable and removable door hangers for precision fit and finish. The hangers utilize three wheel, nylon encapsulated ball bearing hangers for a quiet and smooth roll.

For converging doors, 3 doors going right and 3 doors going left, meeting in the middle, just order two hardware sets. One for each side.



# 111PD Commercial Grade Pocket Door Hardware

for a 3/4" or Thicker Door to 80 lbs. (150 lbs. with 1025 Hangers)



## ORDERING DATA

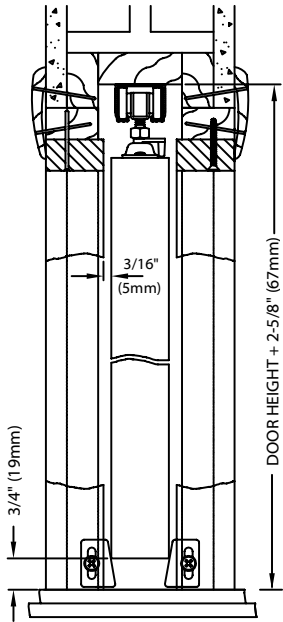
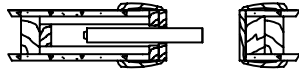

### 111PD

Item No.	Max Door Size	Lbs./Case
111481DR	One 2'0" Door	8/5
111601DR	One 2'6" Door	9/5
111721DR	One 3'0" Door	10/5
111961DR	One 4'0" Door	12/5

#### 111PD Components

Qty	Part #
1	111 Track
2	1020 Hangers
1	1550 Guides
1	1513 Bumper
1	1712 Wrench

Can be used for pocket doors or in combination with itself to make special installations of sliding doors. Aluminum track with convex rails, jump proof three wheel (3/4" dia.) hangers assure a smooth, quiet operation. Brass-tone steel parts. Tracks can be cut down for smaller applications. *Optional Hanger #1025 available for doors up to 150 lbs.-Add \$8.78 (Bulk Only).*

Bulk 25/Case

#### 111PD Hardware Set

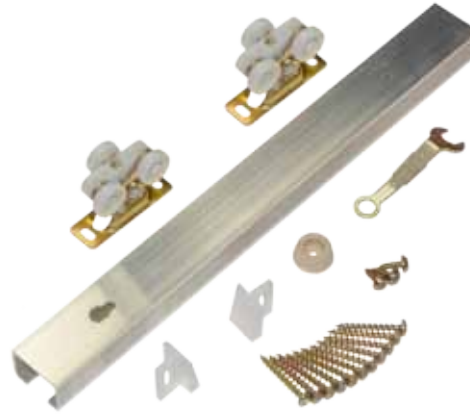

# 111BP Commercial Grade Bypass Pocket Door Hardware

for 1 3/8", 1 3/4", or 2 1/4" Doors to 150 lbs./each



## ORDERING DATA

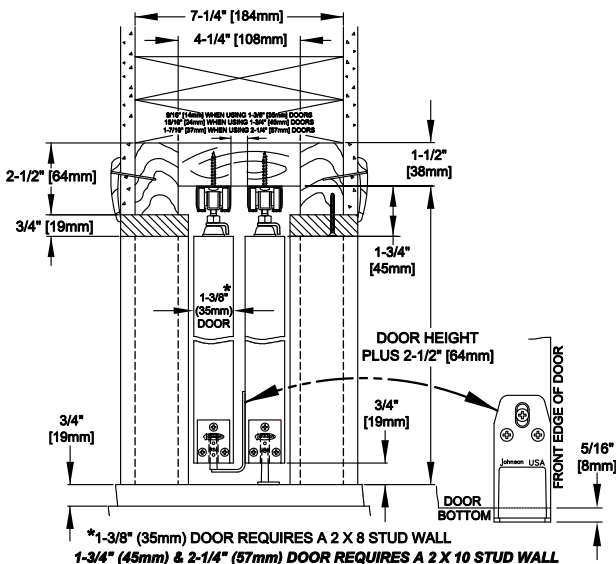

### 111BP

A commercial grade bypass pocket door hardware set that can carry heavy doors up to 150 lbs. per door. No bottom track required. It utilizes trackless guide posts allowing the doors to guide each other. The set includes precision extruded aluminum "Jump Proof" box tracks. They use fully adjustable and removable door hangers for precision fit and finish. The hangers utilize three wheel, nylon encapsulated ball bearing hangers for a quiet and smooth roll. Similar to the 100 Series, but with 3/4" dia wheels instead of 1" dia wheels.

For converging doors, 2 doors going right and 2 doors going left, meeting in the middle, just order two hardware sets. One for each side.

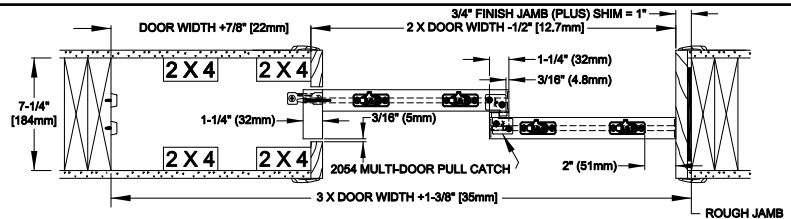

Item No.	Max Door Size	Lbs./Case
11BP0721	Two 2'0" Doors 1 3/8" Thick	Bulk Only
11BP0722	Two 2'0" Doors 1 3/4" Thick	5/Case
11BP0961	Two 2'8" Doors 1 3/8" Thick	Bulk Only
11BP0962	Two 2'8" Doors 1 3/4" Thick	5/Case
11BP1061	Two 3'0" Doors 1 3/8" Thick	Bulk Only
11BP1062	Two 3'0" Doors 1 3/4" Thick	5/Case
11BP1441	Two 4'0" Doors 1 3/8" Thick	Bulk Only
11BP1442	Two 4'0" Doors 1 3/4" Thick	5/Case

\*\*\*Sets for 2 1/4" Thick Doors Also Available\*\*\*



# 111MP Commercial Grade Multi Pass Pocket Door Hardware for 1 3/8", 1 3/4", or 2 1/4" Doors to 150 lbs./each



## ORDERING DATA

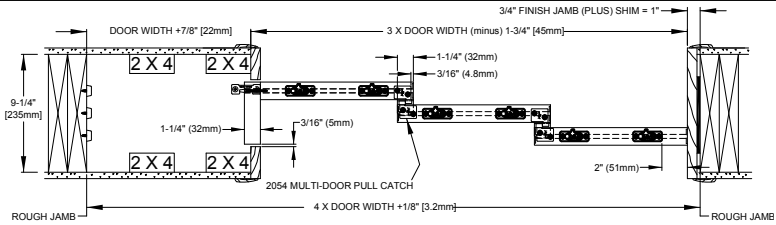
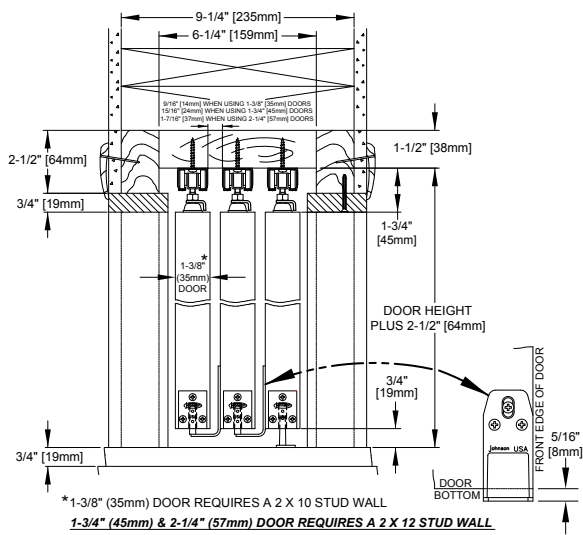

Item No.	Max Door Size	Lbs./Case
11MP0961	Three 2'0" Doors 1 3/8" Thick	Bulk Only
11MP0962	Three 2'0" Doors 1 3/4" Thick	5/Case
11MP1201	Three 2'6" Doors 1 3/8" Thick	Bulk Only
11MP1202	Three 2'6" Doors 1 3/4" Thick	5/Case
11MP1441	Three 3'0" Doors 1 3/8" Thick	Bulk Only
11MP1442	Three 3'0" Doors 1 3/4" Thick	5/Case
11MP1921	Three 4'0" Doors 1 3/8" Thick	Bulk Only
11MP1922	Three 4'0" Doors 1 3/4" Thick	5/Case

\*\*\*Sets for 2 1/4" Thick Doors Also Available\*\*\*

## 111MP

A commercial grade multi pass pocket door hardware set that can carry heavy doors up to 150 lbs. per door. No bottom track required. It utilizes trackless guide posts allowing the doors to guide each other. The set includes precision extruded aluminum "Jump Proof" box tracks. They use fully adjustable and removable door hangers for precision fit and finish. The hangers utilize three wheel, nylon encapsulated ball bearing hangers for a quiet and smooth roll. Similar to the 100 Series, but with 3/4" dia wheels instead of 1" dia wheels.

For converging doors, 3 doors going right and 3 doors going left, meeting in the middle, just order two hardware sets. One for each side.



## 1521 (For 1 3/8" Doors Only) 1534 (For 1 3/4" Doors Only)

## Pocket Door Privacy Locks



## ORDERING DATA



## 1521/1534



For Converging Doors Use One Privacy Lock, One Dummy Pull, and Two Edge Pulls

### 21-PPK/134 "Suncrest" Dummy Pull

US3-Bright Brass

US15-Satin Nickel



Item No.	Description	Color	Door Thickness	LBS/Case
15213PK1	Privacy Lock	US3/Brt. Brass	1 3/8"	2.5/5
152115P1	Privacy Lock	US15/Sat. Nic.	1 3/8"	2.5/5
1521-BLK	Privacy Lock	Black	1 3/8"	12.5/25
21-3PPK2	Dummy Pull	US3/Brt. Brass	1 3/8"	2.6/10
21-15PK2	Dummy Pull	US15/Sat. Nic.	1 3/8"	2.6/10
121BLK	Dummy Pull	Black	1 3/8"	5/25
1534-3P1	Privacy Lock	US3/Brt. Brass	1 3/4"	1/1
153415P1	Privacy Lock	US15/Sat. Nic.	1 3/4"	1/1
1534-BLK	Privacy Lock	Black	1 3/4"	2.4/5
134US3	Dummy Pull	US3/Brt. Brass	1 3/4"	3/10
134US15	Dummy Pull	US15/Sat. Nic.	1 3/4"	3/10
134BLK	Dummy Pull	Black	1 3/4"	5/25
150-3PK1	Edge Pull	US3/Brt. Brass	Universal	2/10
150-15P1	Edge Pull	US15/Sat. Nic.	Universal	2/10

150US15 Edge Pull  
Satin Nickel



150US3 Edge Pull  
Bright Brass

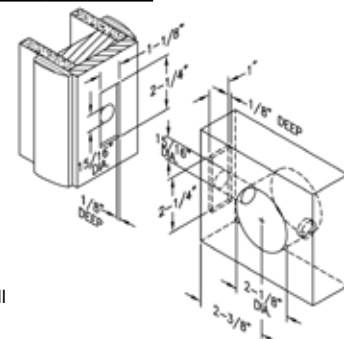



**ORDERING DATA**

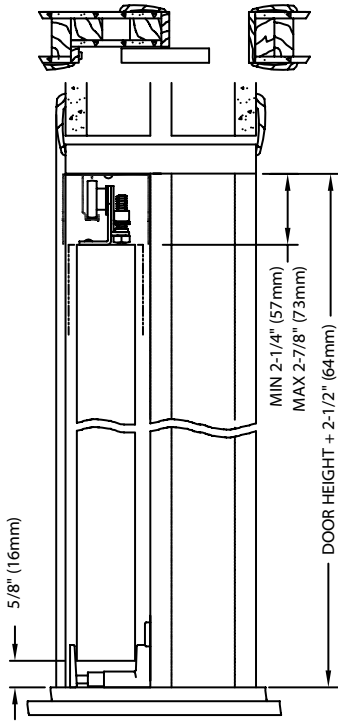

**2800F**

Item No.	Max Door Size	Lbs./Case
2800F481	One 2'0" Door	Bulk Only-20/Case
2800F601	One 2'6" Door	Bulk Only-20/Case
2800F721	One 3'0" Door	4/1
2800F961	One 4'0" Door	5/1

2800F Components

Qty	Part #
1	2800F Track
2	2815 Hangers
1	12 Guide
1	1513 Bumper
1	1712 Wrench

Space saving, header mounted "Open Pocket Door" hardware set. Aluminum double fascia track with a single convex rail, twin wheel (7/8" dia.) ball bearing hangers, wall mount guide. Brass-tone steel parts.

2800F Hardware Set

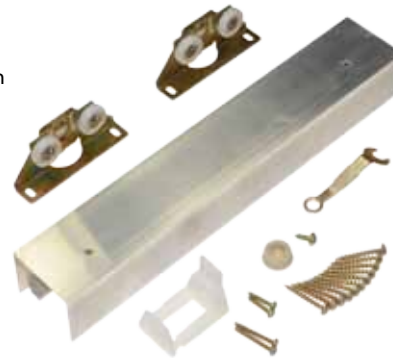

**2800** (Aluminum Track and Hardware Set) Pocket Door Hardware  
**2850** (Steel Track and Hardware Set) For a 1 1/8" or Thicker Door to 50 lbs.



**ORDERING DATA**

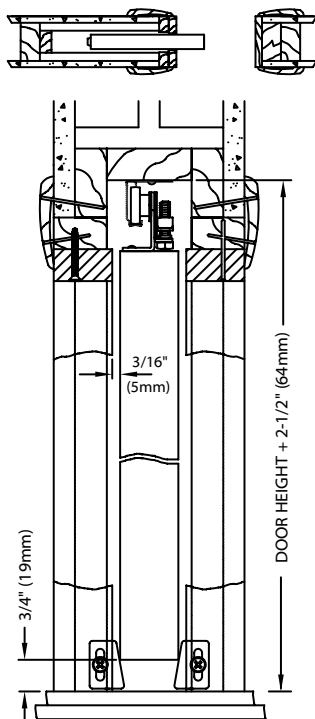

**2800/2850**

Item No.	Max Door Size	Lbs./Case
2800481D	One 2'0" Door	Bulk Only-25/Case
2800601D	One 2'6" Door	Bulk Only-25/Case
2800721D	One 3'0" Door	9/5
2800961D	One 4'0" Door	11/5
2850481D	One 2'0" Door	Bulk Only-25/Case
2850601D	One 2'6" Door	Bulk Only-25/Case
2850721D	One 3'0" Door	11/5
2850961D	One 4'0" Door	14/5

2800/2850 Components

Qty	Part #
1	2800/2850 Track
2	2802 Hangers
1	1550 Guides
1	1513 Bumper
1	1712 Wrench

An economical track and hardware set with a single convex rail, which provides one point contact between wheel and track. One wheel (7/8" dia.) hanger. Brass-tone steel parts. 2800 Series offers an upgraded aluminum track. 2850 Series offers an entry-level steel track.

2800 Hardware Set



2850 Hardware Set



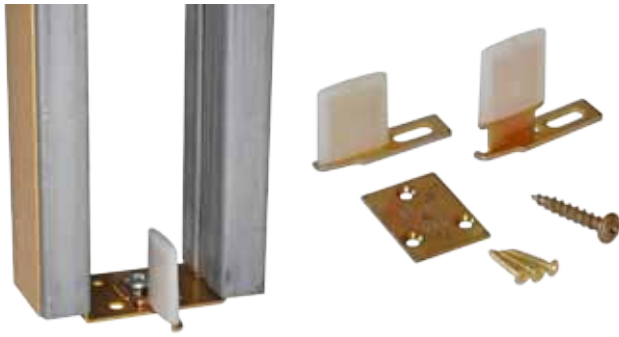

Item No.	Lbs./Case Qty
2041PLBG	1.7/10

The 2041 Hidden Pocket Door Guide Kit permits pocket door guiding without the use of standard 1550 visible pocket door guides. The heavy duty steel reinforced guide post is fastened to the center of the Split Stud Floor Plate just inside the pocket and rides inside a groove routed in the bottom edge of the door out of view for a clean look. 2 guide posts are included in the kit, one for sub floor and one for finished floor applications..

The 2041PLBG works with all Johnson Pocket Door Frames except 2710/2711.

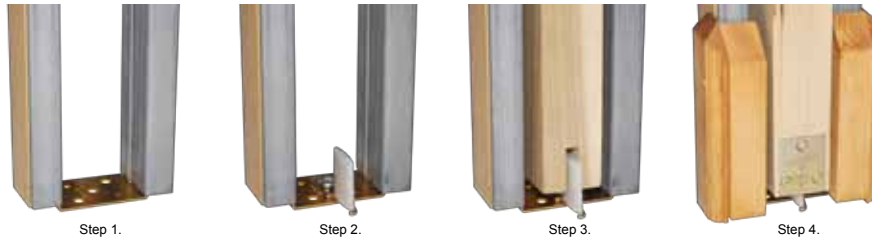

Step 1.

Step 2.

Step 3.

Step 4.

## Panel Displays

### USING JOHNSON 100 SERIES TRACK AND HARDWARE



#### NO MORE WRESTLING WITH LOOSE PANELS OR DOORS!

Display your doors with easy-to-construct sliding "show walls". These displays take up less floor space than the old methods of stacking or leaning doors.

The **Door Panel Display** uses the same track and hanger system as the Johnson 1500 Pocket Door Frame and can handle 3'0" doors up to 200 lbs..

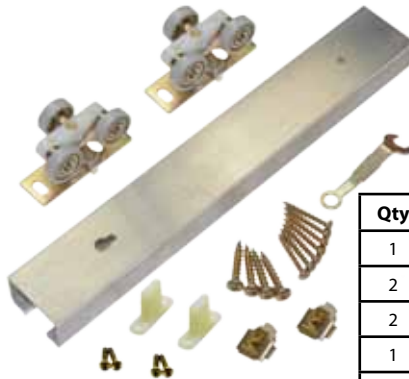

Qty	Part #
1	100-0072
2	1125 Hangers
2	10 Guide
1	1712 Wrench
2	1155 Stops

Item No.	Length	Pkg/Qty	Wt/Ctn
100721DD	72"	25/Ctn	75 lbs.



## Valet Rod

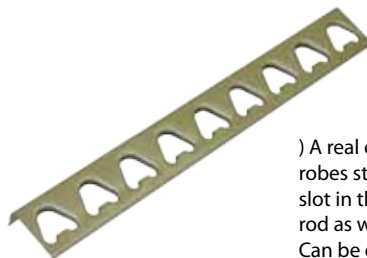
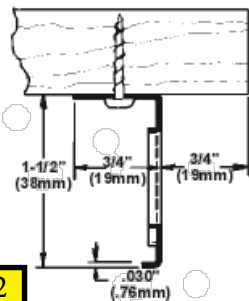

Item No.	Lbs./Case
9500-096	32/20(Bulk Only)

) A real clothing organizer. Hangers are separated eliminating "hanger overlap". Wardrobes stay neat and orderly. Clothing stays fresh and unwrinkled. Deep drawn hanger slot in the gold enameled steel Valet/rod will not scratch hangers, provide strength to rod as well as the shelf above. Available bulk only in 96" (2438mm) lengths. Can be easily cut for smaller shelves. Use short lengths near washers for drip dry or wrinkle free.

# 200SD Heavy Duty Bypass Track and Hardware for 1 1/8" or Thicker Doors to 400 lbs.



## ORDERING DATA

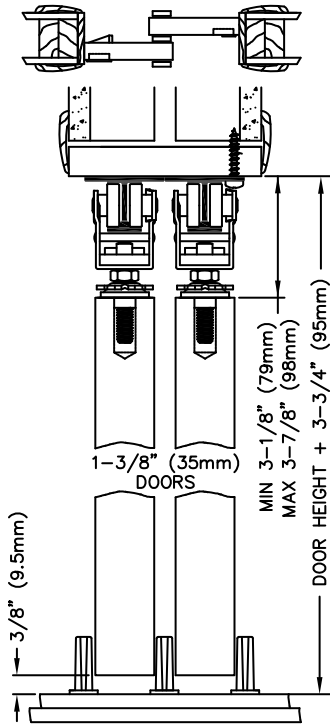

### 200SD

Item No.	Opening Size	Lbs./Case
200482DR	48"-2 Door	Bulk Only-5/Case
200602DR	60"-2 Door	Bulk Only-5/Case
200722DR	72"-2 Door	14/1
200962DR	96"-2 Door	17/1

#### 200SD 2 DR Components

Qty	Part #
2	200 Track
4	2020 Hangers
3	2031 Guides
1	2155 Door Stop
2	30US15 Pull

A deluxe commercial grade hardware set. Heavy duty extruded aluminum I-beam track. Four wheel ball bearing hangers with machine turned 1" wheels. Heavy duty guide with steel reinforced nylon posts. Brass-tone steel parts. Tracks can be spaced out to accommodate non-standard door thicknesses greater than 1-1/8". Tracks can be cut down for smaller openings.



1 3/8", 1 3/4", and 2 1/4" Side Mount Hardware Available



200SD 2 DR Hardware Set

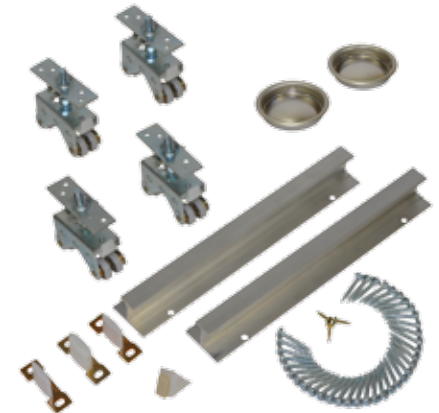

# 100SD Heavy Duty Bypass Track and Hardware for 1" or Thicker Doors to 200 lbs.



## ORDERING DATA

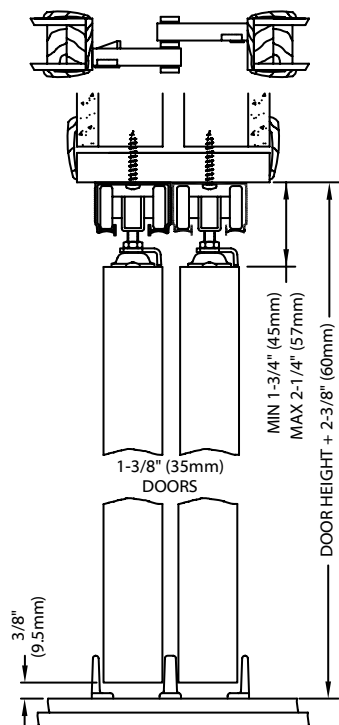

### 100SD

Item No.	Opening Size	Lbs./Case
100482DR	48"-2 Door	4.5/1
100602DR	60"-2 Door	5.3/1
100722DR	72"-2 Door	6/1
100962DR	96"-2 Door	7.7/1

#### 100SD 2 Door Components

Qty	Part #
2	100 Track
4	1125 Hangers
1	101 Guide Set
1	2155 Door Stop
2	30US15 Pull
1	1712 Wrench

A commercial grade bypass sliding door hardware set for doors weighing up to 200 pounds each. Heavy-duty extruded aluminum box track utilizes three-wheeled ball-bearing rollers (#1125) with 1" diameter machine turned wheels. The three piece guide is adjustable for different thicknesses of doors. (minimum door thickness is 1")



1 3/8" and 1 3/4" Side Mount Hardware Available



◀◀ **SOFT-Close/Open** ▶▶

Compatible

100SD Hardware Set

# 111SD Heavy Duty Bypass Track and Hardware for 3/4" or Thicker Doors to 150 lbs.



## ORDERING DATA

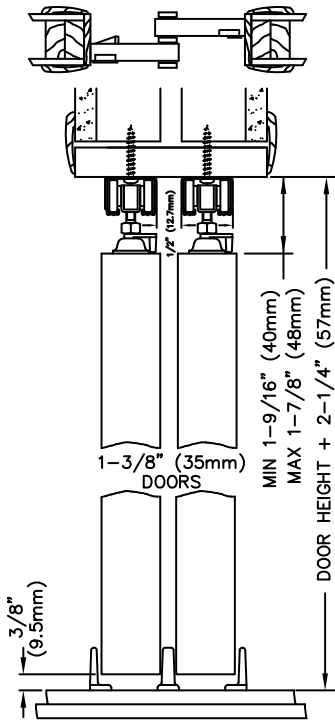

**111SD**

Item No.	Opening Size	Lbs./Case
111482DR	48"-2 Door	4.7/1
111602DR	60"-2 Door	5.2/1
111722DR	72"-2 Door	5.7/1
111962DR	96"-2 Door	6.9/1

### 111SD 2 Door Components

Qty	Part #
2	111 Track
4	1025 Hangers
1	101 Guide Set
1	2155 Door Stop
2	30US15 Pull
1	1712 Wrench

A commercial grade bypass sliding door hardware set for doors weighing up to 150 pounds each. Heavy-duty extruded aluminum box track utilizes three-wheeled ball-bearing rollers (#1025) with 3/4" diameter machine turned wheels. The three piece guide is adjustable for different thicknesses of doors. (minimum door thickness is 3/4")



111SD Hardware Set



# 134F Heavy Duty Bypass Track and Hardware for 1 3/4" Doors to 125 lbs. (200 lbs. with 1125 Ball Bearing Hanger)



## ORDERING DATA

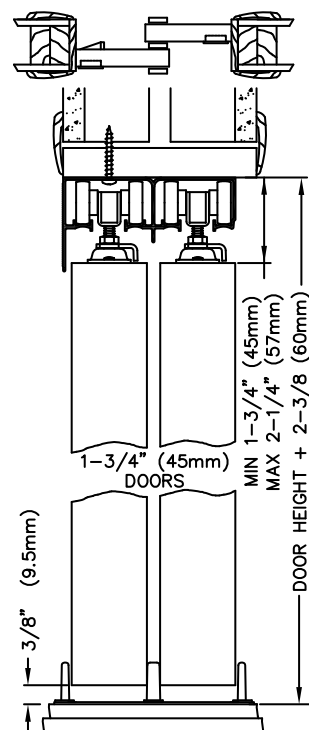

**134F**

Item No.	Opening Size	Lbs./Case
134F482D	48"-2 Door	24/5
134F602D	60"-2 Door	29/5
134F722D	72"-2 Door	33/5
134F964D	96"-4 Door	30/3

### 134F 2 Door Components

Qty	Part #
1	134F Track
4	1120 Hangers
1	2134 Guide Set
1	2155 Door Stop
2	30US15 Pull
1	1712 Wrench

### 134F 4 Door Components

Qty	Part #
1	134F Track
8	1120 Hangers
2	2134 Guide Set
2	2155 Door Stop
4	30US15 Pull
1	1712 Wrench
2	1155 Stop

Commercial grade track (for 1 3/4" thick doors) with an aluminum fascia which hides hangers from view. Three wheel (1" dia.) hangers ride on convex rails for a smooth, quiet operation. Door guide is woodtone with pivot action that align guide posts with door. Brass-tone, steel parts.

\*Optional hanger #1125 available for doors to 200 lbs./each.-



134F Hardware Set

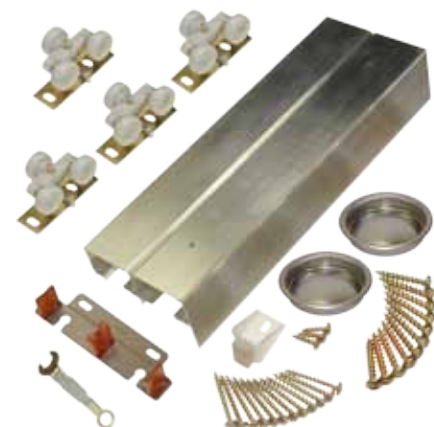

1 3/4" Side Mount Hardware Available  
(200 lbs. Rating)





# 138F Heavy Duty Bypass Track and Hardware for 1 3/8" Doors to 125 lbs. (200 lbs. with 1125 Ball Bearing Hanger)



## ORDERING DATA

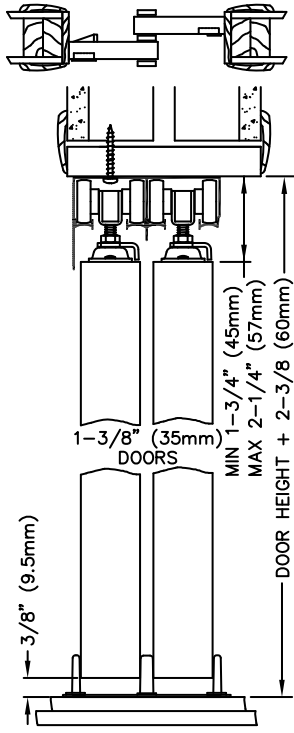

**138F**

**SOFT-Close/Open**

Compatible

Item No.	Opening Size	Lbs./Case
138F482D	48"-2 Door	22/5
138F602D	60"-2 Door	26/5
138F722D	72"-2 Door	30/5
138F964D	96"-4 Door	26/3

### 138F 2 Door Components

Qty	Part #
1	138F Track
4	1120 Hangers
1	2135 Guide Set
1	2155 Door Stop
2	30US15 Pull
1	1712 Wrench

### 138F 4 Door Components

Qty	Part #
1	138F Track
8	1120 Hangers
2	2135 Guide Set
2	2155 Door Stop
4	30US15 Pull
1	1712 Wrench
2	1155 Stop

Commercial grade track (for 1 3/8" thick doors) with an aluminum fascia which hides hangers from view. Three wheel (1" dia.) hangers ride on convex rails for a smooth, quiet operation. Door guide is woodtone with pivot action that align guide posts with door. Brass-tone, steel parts.

Optional hanger #1125 available for doors to 200 lbs./each.



Bronze anodized track is available. 200 lbs. rating. Includes 1125 Hangers



1 3/8" Side Mount Hardware Available (200 lbs. Rating)



### 138F Hardware Set



# 118F Heavy Duty Bypass Track and Hardware for 1 1/8" Doors to 80 lbs. (150 lbs. with 1025 Ball Bearing Hanger)



## ORDERING DATA

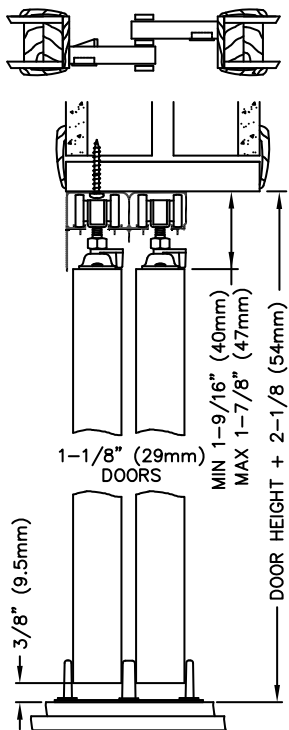

**118F**

Item No.	Opening Size	Lbs./Case
118F482D	48"-2 Door	4/1
118F602D	60"-2 Door	5/1
118F722D	72"-2 Door	6/1
118F964D	96"-4 Door	7/1

### 118F 2 Door Components

Qty	Part #
1	118F Track
4	1020 Hangers
1	2118 Guide Set
1	2155 Door Stop
2	30US15 Pull
1	1712 Wrench

### 118F 4 Door Components

Qty	Part #
1	118F Track
8	1020 Hangers
2	2118 Guide Set
2	2155 Door Stop
4	30US15 Pull
1	1712 Wrench
2	1155 Stop

Commercial grade track (for 1 1/8" thick doors) with an aluminum fascia which hides hangers from view. Three wheel (3/4" dia.) hangers ride on convex rails for a smooth, quiet operation. Door guide is woodtone with pivot action that align guide posts with door. Brass-tone, steel parts.

\*Optional hanger #1025 available for doors to 150 lbs./each



### 118F Hardware Set



# 2200F Residential Grade Bypass Fascia Track and Hardware for 1 3/8" Doors to 50 lbs. (One Wheel) or 75 lbs. (Two Wheel)



## ORDERING DATA

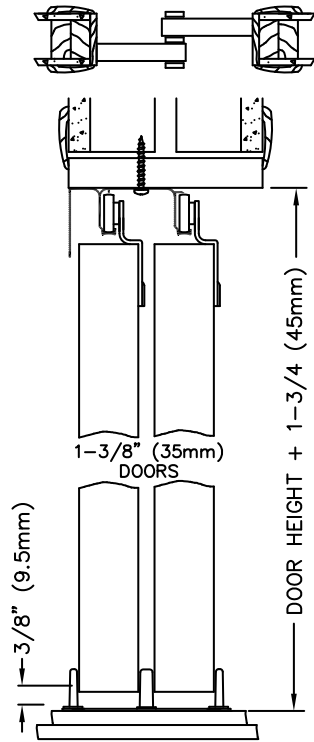

**2200F**

Item No.	Opening Size	Lbs./Case
2200F481	48"-2 Door	13/5
2200F601	60"-2 Door	15/5
2200F721	72"-2 Door	16/5
2200F961	96"-4 Door	26/5
*2200F482	48"-2 Door	14/5
*2200F602	60"-2 Door	16/5
*2200F722	72"-2 Door	18/5
*2200F962	96"-4 Door	27/5

### 2200F 2 Door Components

Qty	Part #
1	2200F Track
4	2238 Hangers (2228 2 Whl)
1	2135 Guide Set
2	15US15 Pull

### 2200F 4 Door Components

Qty	Part #
1	2200F Track
8	2238 Hangers (2228 2 Whl)
2	2135 Guide Set
1	2255 Stop Kit
4	15US15 Pull

An aluminum fascia track with "Hi-Lite" design to hide blemishes that may occur. Convex track rails that provide one point contact between wheel and track. Hangers include one or two wheels (7/8" dia.) with three point locking. Hangers adjust without removing or relocating screws. Woodtone guide adjusts laterally for quick plumbing. Nylon guide posts are 1" high, guide posts swivel to allow warped doors to operate without binding. Brass-tone steel parts.

\* 2 Wheel Hangers for 75 lbs. per door.



2200F Hardware Set



# 2204F Residential Grade Bypass Fascia Track and Hardware for 3/4" Doors to 50 lbs.



## ORDERING DATA

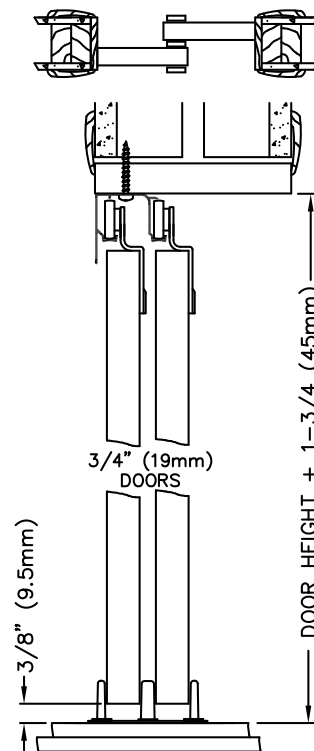

**2204F**

Item No.	Opening Size	Lbs./Case
2204F481	48"-2 Door	Bulk Only/
2204F601	60"-2 Door	20/Carton
2204F721	72"-2 Door	15/5
2204F961	96"-4 Door	22/5

### 2204F 2 Door Components

Qty	Part #
1	2204F Track
4	2238 Hangers (2228 2 Whl)
1	2175 Guide
2	15US15 Pull

### 2204F 4 Door Components

Qty	Part #
1	2204F Track
8	2238 Hangers (2228 2 Whl)
2	2175 Guide Set
1	2255 Stop Kit
4	15US15 Pull

A premium, residential bypass set for 3/4" thick doors. Uses an aluminum fascia track with "Hi-Lite" design to hide blemishes that may occur. Convex track rails that provide one point contact between wheel and track. Hangers include one or two wheels (7/8" dia.) with three point locking. Hangers adjust without removing or relocating screws. Woodtone guide adjusts laterally for quick plumbing. Nylon guide posts are 1" high, guide posts swivel to allow warped doors to operate without binding. Brass-tone steel parts.



2204F Hardware Set



# 2222 Residential Grade Bypass Track and Hardware with Wood Header for 1 3/8" Doors to 50 lbs. (One Wheel) or 75 lbs. (Two Wheels)



## ORDERING DATA

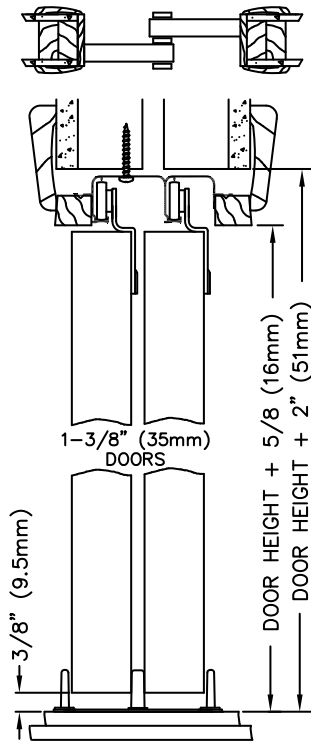

**2222**

Item No.	Opening Size	Lbs./Case
22224814	48"-2 Door	
22226014	60"-2 Door	
22227214	72"-2 Door	Bulk
22229614	96"-4 Door	Only
*22224824	48"-2 Door	10/Case
*22226024	60"-2 Door	
*22227224	72"-2 Door	
*22229624	96"-4 Door	

### 2222 2 Door Components

Qty	Part #
1	2222 Track
4	2238 Hangers (2228 2 Whl)
1	2135 Guide Set
2	15US15 Pull

### 2222 4 Door Components

Qty	Part #
1	2222 Track
8	2238 Hangers (2228 2 Whl)
2	2135 Guide Set
1	2255 Stop Kit
4	15US15 Pull

Prefabricated header with aluminum track replaces the regular head jamb. Keeps the bypass doors the same trim height as swinging doors. Eliminates odd door heights. Convex track rails, 7/8" dia. wheels, adjustable hangers, adjustable guide. Brass-tone steel parts. Also available for 5/4" jamb and without wood. Contact factory.

\* 2 Wheel Hangers for 75 lbs. per door.



2222 Hardware Set

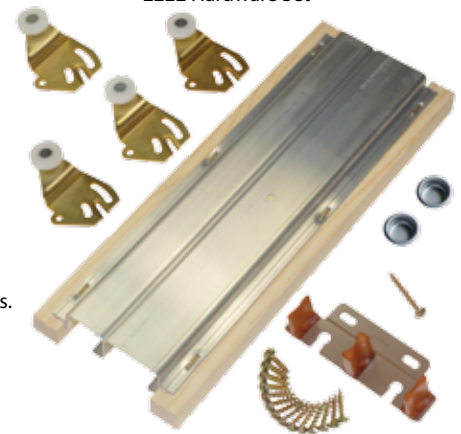

# 2200 Bypass Track and Hardware for 3/4" or 1 3/8" Doors to 50 lbs.



## ORDERING DATA

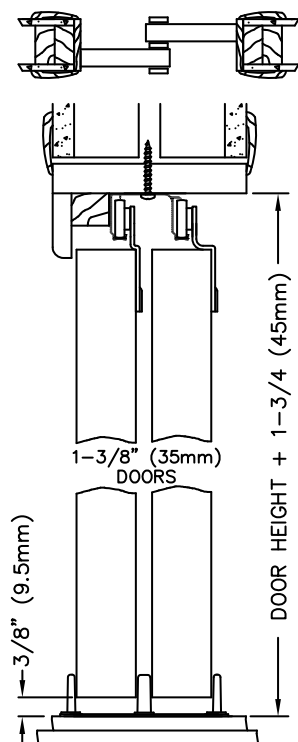

**2200**

Item No.	Opening Size	Lbs./Case
2200482D	48"-2 Door	10/5
2200602D	60"-2 Door	12/5
2200722D	72"-2 Door	13/5
2200964D	96"-4 Door	19/5

### 2200 2 Door Components

Qty	Part #
1	2200 Track
2	2216 Hangers
2	2238 Hangers
1	2135 Guide
2	15US15 Pulls

### 2200 4 Door Components

Qty	Part #
1	2200 Track
4	2216 Hangers
4	2238 Hangers
2	2135 Guides
4	15US15 Pulls
1	2255 Stop Kit

Aluminum bypass track with convex track rails for quiet, smooth operation. One wheel (7/8" dia.) hangers with three point locking provide one point contact between wheel and track. One inch high woodtone adjustable door guide. Brass-tone steel parts.



2200 Hardware Set



# 1166 Bypass Track and Hardware for 3/4" or 1 3/8" Doors to 50 lbs.



## ORDERING DATA

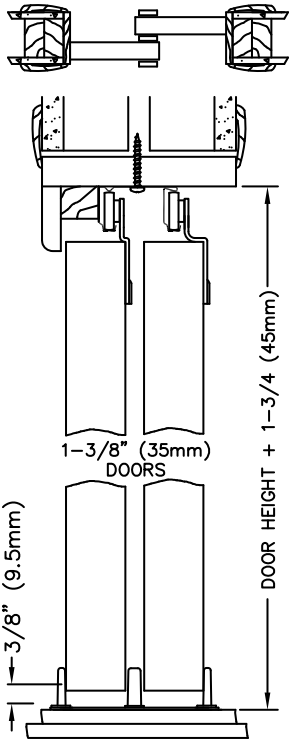

### 1166

Item No.	Opening Size	Lbs./Case
1166G482	48"-2 Door	13/5
1166G602	60"-2 Door	16/5
1166G722	72"-2 Door	18/5
1166G964	96"-4 Door	26/5

#### 1166 2 Door Components

Qty	Part #
1	1166 Track
2	2216 Hangers
2	2238 Hangers
1	2135 Guide
2	15US15 Pulls

#### 1166 4 Door Components

Qty	Part #
1	1166 Track
4	2216 Hangers
4	2238 Hangers
2	2135 Guides
4	15US15 Pulls
1	2255 Stop Kit

An economical prefinished gold colored steel bypass track with convex track rails, which provide one point contact between wheel and track. One wheel (7/8" dia.) hangers with three point locking. One inch high woodtone adjustable door guide. Brass-tone steel parts.



1166 Hardware Set



# 113F Bypass Fascia Track and Hardware For 1 3/8" Doors to 50 lbs.



## ORDERING DATA

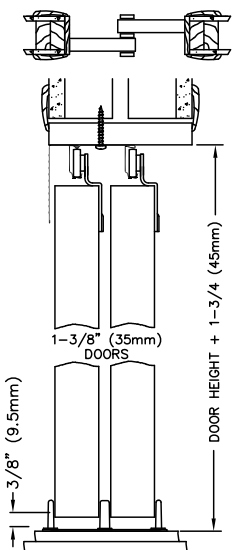

### 113F

#### 113F 2 Dr Components

Qty	Part #
1	1138 Track
1	126F Fascia
4	2238 Hangers
1	2135 Guide
2	15US15 Pulls

#### 113F 4 Dr Components

Qty	Part #
1	1138 Track
1	126F Fascia
8	2238 Hangers
2	2135 Guide
4	15US15 Pulls
1	2255 Stop Kit

An economical prefinished gold colored steel bypass track with a "Snap-on Fascia". Convex track rails, which provide one point contact between wheel and track. One wheel (7/8" dia.) hangers with three point locking. One inch high woodtone adjustable door guide. Brass-tone steel parts.

Item No.	Opening Size	Lbs./Case
113FG481	48"-2 Door	19/5
113FG601	60"-2 Door	23/5
113FG721	72"-2 Door	27/5
113FG961	96"-4 Door	27/5

# 1138 Bypass Track and Hardware For 1 3/8" Doors to 50 lbs.



## ORDERING DATA

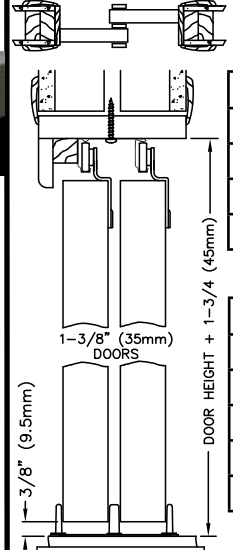

### 1138

#### 1138 2 Dr Components

Qty	Part #
1	1138 Track
4	2238 Hangers
1	2135 Guide
2	15US15 Pulls

#### 1138 4 Dr Components

Qty	Part #
1	1138 Track
8	2238 Hangers
2	2135 Guide
4	15US15 Pulls
1	2255 Stop Kit

An economical prefinished gold colored steel bypass track with convex track rails, which provide one point contact between wheel and track. One wheel (7/8" dia.) hangers with three point locking. One inch high woodtone adjustable door guide. Brass-tone steel parts.

Item No.	Opening Size	Lbs./Case
1138482D	48"-2 Door	13/5
1138602D	60"-2 Door	16/5
1138722D	72"-2 Door	19/5
1138964D	96"-4 Door	27/5

# Multiple-Door Sliding Door Hardware

## 200MD, 100MD, 111MD



Shown below are typical 3 track layouts for 1-3/8" doors. Other door thicknesses may be used. For thicker doors, the tracks must be spaced further apart and a wider header may be necessary. Also, more than 3 tracks may be used by extending the header and using other track combinations as required.



### 200MD Series-400 lbs. Doors

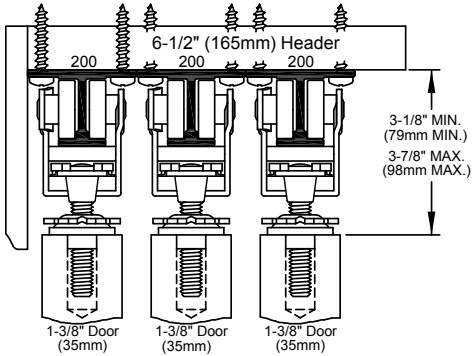

### 100MD Series-200 lbs. Doors

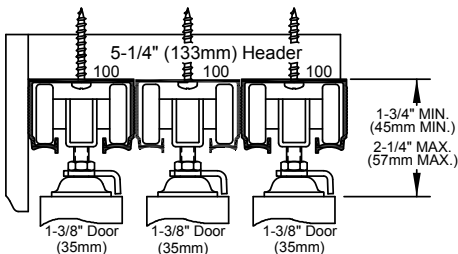

Compatible

### 111MD Series-150 lbs. Doors

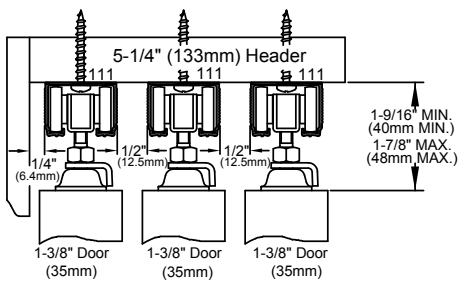

### 1050 Bottom Track- Included w/ all Sets

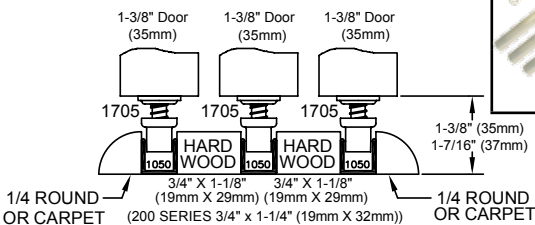

All nosing and hardware filler supplied by others. Surface mount shown/ Bottom channel may be recessed into floor. Spacing and dimensions will vary with other door thicknesses.

Tracks can be cut down for smaller openings.

### 6', 8', and 9' Sets Utilizing 200, 100, and 111 Hardware Sets.

200MD Series Hardware Sets- 400lbs Doors (min 1-1/8" thick)				
Set Image	Part #	Track Length	Max Door Width (ea)	Max Door Weight (ea)
	200M0723	70" 1829mm	24" x 3 610mm x 3	400 lbs. 182 kgs.
	200M0963	94" 2438mm	32" x 3 813mm x 3	400 lbs. 182 kgs.
	200M1083	106" 2692mm	36" x 3 914mm x 3	400 lbs. 182 kgs.
	200M1443	142" 3657mm	48" x 3 1219mm x 3	400 lbs. 182 kgs.
Set consists of 3-200 tracks, 3-1050 bottom tracks, 6-2020 hangers, 6-1705 guides, and 2-2055 track stops.				

100MD Series Hardware Sets- 200lbs Doors (min 1" thick)				
Set Image	Part #	Track Length	Max Door Width (ea)	Max Door Weight (ea)
	100M0723	70" 1829mm	24" x 3 610mm x 3	200 lbs. 91 kg.
	100M0963	94" 2438mm	32" x 3 813mm x 3	200 lbs. 91 kg.
	100M1083	106" 2692mm	36" x 3 914mm x 3	200 lbs. 91 kg.
	100M1443	142" 3657mm	48" x 3 1219mm x 3	200 lbs. 91 kg.
Set consists of 3-100 tracks, 3-1050 bottom tracks, 6-1125 hangers, 6-1705 guides, and 2-1155 track stops.				

111MD Series Hardware Sets- 150lbs Doors (min 3/4" thick)				
Set Image	Part #	Track Length	Max Door Width (ea)	Max Door Weight (ea)
	111M0723	70" 1829mm	24" x 3 610mm x 3	150 lbs. 68 kgs.
	111M0963	94" 2438mm	32" x 3 813mm x 3	150 lbs. 68 kgs.
	111M1083	106" 2692mm	36" x 3 914mm x 3	150 lbs. 68 kgs.
	111M1443	142" 3657mm	48" x 3 1219mm x 3	150 lbs. 68 kgs.
Set consists of 3-111 tracks, 3-1050 bottom tracks, 6-1025 hangers, 6-1705 guides, and 2-1155 track stops.				



2054 PLBG  
MULTI PULL CATCH

2054PLBG

Multi Pull Catch

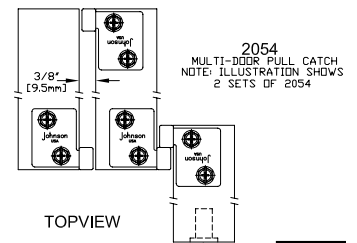

TOPVIEW  
USE 150 EDGE PULL ON LEAD DOOR









<p><b>100 Series</b> Aluminum 25/case</p> <p>100</p>	<p><b>1138 Series</b> Steel 20/case</p> <p>1138</p>	<p><b>2204F Series</b> Aluminum 25/case</p> <p>2204F</p>
36" 48" 60" 72" 96" 106" 120" 144" 192"	47" 59" 71" 94" 106" 120" 144" 192"	48" 60" 72" 96" 106" 120" 144" 192"
<p><b>111 Series</b> Aluminum 25/case</p> <p>111</p>	<p><b>1166 Series</b> Steel 25/case</p> <p>1166</p>	<p><b>2222 Series</b> Aluminum</p> <p>with 4 9/16" wood 10/case without wood 25/case</p> <p>2222</p>
36" 48" 60" 72" 96" 106" 120" 144" 192"	47" 59" 71" 94" 106" 120" 144" 192"	48" 60" 72" 96" 106" 120" 144" 192"
<p><b>118F Series</b> Aluminum 10/case</p> <p>118F</p>	<p><b>126F Fascia</b> Steel 20/case Goldtone Woodtone</p> <p>126F</p>	<p><b>2610F Series</b> Aluminum 10/case</p> <p>2610F</p>
48" 60" 72" 96" 106" 120" 144" 192"	48" 60" 72" 96" 106" 120" 144" 192"	48" 60" 72" 96" 106" 120" 144" 192"
<p><b>134F Series</b> Aluminum 10/case</p> <p>134F</p>	<p><b>1700 Series</b> Steel 25/case Brown White</p> <p>1700</p>	<p><b>2610FB Series</b> Aluminum Ant. Bronze 10/case</p> <p>2610F</p>
48" 60" 72" 96" 106" 120" 144" 192"	24" 30" 32" 36" 48" 60" 72" 96"	48" 60" 72" 96" 106" 120" 144" 192"
<p><b>138F Series</b> Aluminum 10/case</p> <p>138F</p>	<p><b>1825/1838</b> Steel 25/case Brown White</p> <p>1825</p>	<p><b>2800 Series</b> Aluminum 25/case</p> <p>2800</p>
48" 60" 72" 96" 106" 120" 144" 192"	24" 30" 32" 36" 48" 60" 72" 96"	48" 60" 72" 96" 106" 120" 144" 192"
<p><b>170A Series</b> Aluminum 20/case</p> <p>170A</p>	<p><b>1855 Threshold</b> Steel 25/case Woodtone White</p> <p>1855</p>	<p><b>2800F Series</b> Aluminum 20/case</p> <p>2800F</p>
24" 30" 32" 36" 48" 60"	24" 30" 36" 48" 60" 72" 96"	48" 60" 72" 96" 106" 120" 144" 192"
72" 96" 106" 120" 144" 192"		
<p><b>200 Series</b> Aluminum 5/case</p> <p>200</p>	<p><b>2200 Series</b> Aluminum 25/case</p> <p>2200</p>	<p><b>2850 Series</b> Steel 25/case Goldtone</p> <p>2850</p>
48" 60" 72" 96" 106" 120" 144" 192"	47" 59" 71" 94" 106" 120" 144" 192"	48" 60" 72" 96" 106" 120" 144" 192"
<p><b>1050 Bot. Chan.</b> 1050 Aluminum 6/case</p> <p>1050</p>	<p><b>2200F Series</b> Aluminum 25/case</p> <p>2200F</p>	<p>Drawings not to scale</p>
72" 96" 106" 144"	48" 60" 72" 96" 106" 120" 144" 192"	

	<b>G1738</b> COMBINATION SLIDING-FOLDING DOOR ASSORTMENT 5-1700363H, 10-1700486H, 5-1700606H, 5-1700726H, 10-1138482D, 5-1138602D, 5-1138722D	G1738
	<b>G2200F</b> SLIDING DOOR ASSORTMENT 20-2200F481, 10-2200F601, 10-2200F721	G2200F
	<b>G9000</b> CLOSET ROD AND SHELF SUPPORT ASSORTMENT 10-9018-30P, 20-9030-48P, 10-9048-72P, 5-9072-96P, 5-9072120P, 20-9003WHEN, 20-9005WHEN, 20-9030PPK3	G9000
	<b>G40</b> 4' MODULAR COMB. SLIDING-FOLDING-POCKET-REPLACEMENT ASSORTMENT <i>(CONSISTS OF THE FOLLOWING G41 AND G42 2' MODULAR SETS)</i>	G40 G40MINI
	<b>G41</b> 2' COMBINATION SLIDING-FOLDING-POCKET ASSORTMENT 5-1166G482, 5-1166G602, 5-1166G722, 5-100721DR, 2-153068PF 5-1700363H, 5-1700486H, 5-1700606H, 5-1700726H	G41 G41MINI
	<b>G42</b> 2' ACCESSORY ASSORTMENT 5-1601218P, 5-2216PPK2, 5-2238PPK2, 5-2136PPK1, 5-1836PPK1, 10-2376PPK2, 10-2378PPK2, 10-2336PPK2, 10-2338PPK2, 10-2135PPK1, 10-1832PPK3, 10-1817PPK3, 10-1808PPK1, 5-1555PPK3, 5-15213PK1, 10-150-3PK1, 5-1500PPK3, 5-1700PPK3, 10-1703PPK2, 10-1805PPK2, 10-15-3PPK3, 10-33--PPK2, 10-2155PPK1, 5-1575PPK3, 10-2312PPK1, 10-1833PPK3	G42 G42MINI
<b>G44</b> (SAME AS G40 EXCEPT W/2200 ALUMINUM TRACK)	G44 G44MINI	
<b>G45</b> (SAME AS G41 EXCEPT W/2200 ALUMINUM TRACK)	G45 G45MINI	
	<b>G60</b> 6' MODULAR COMB. SLIDING-FOLDING-POCKET-REPLACEMENT ASSORTMENT <i>(CONSISTS OF THE FOLLOWING G61, G62, AND G63 2' MODULAR SETS)</i>	G60 G60MINI
	<b>G61</b> 2' COMBINATION SLIDING-FOLDING ASSORTMENT 10-1166G482, 5-1166G602, 5-1166G722, 5-100721DR, 5-1700363H, 10-1700486H, 5-1700606H, 5-1700726H	G61 G61MINI
	<b>G62</b> 2' ACCESSORY ASSORTMENT 5-1601218P, 5-2216PPK2, 5-2238PPK2, 5-2136PPK1, 5-1836PPK1, 10-2376PPK2, 10-2378PPK2, 10-2336PPK2, 10-2338PPK2, 10-2135PPK1, 10-1832PPK3, 10-1817PPK3, 10-1808PPK1, 5-1700PPK3, 10-1703PPK2, 10-1805PPK2, 10-15-3PPK3, 10-33--PPK2, 10-2155PPK1, 10-2312PPK1, 10-1833PPK3 10-38-3PPK1, 10-35-3PPK2, 10-30-3PPK2, 10-40-3PPK2, 36--PPK2, 10-1823PPK2	G62 G62MINI
	<b>G63</b> 2' POCKET DOOR FRAME AND ACCESSORY ASSORTMENT 4-153068PF, 3-15113068, 10-1555PPK3, 5-15213PK1, 5-21-3PPK2, 10-150-3PK1, 5-1500PPK3, 10-1575PPK3,	G63 G63MINI
	<b>G64</b> (SAME AS G60 EXCEPT W/2200 ALUMINUM TRACK)	G64
	<b>G65</b> (SAME AS G61 EXCEPT W/2200 ALUMINUM TRACK)	G65
	<b>MINI1601</b> FULL ACCESS FOLDING DOOR HARDWARE 10-1601218P SETS AND WORKING DISPLAY MODEL	MINI1601
	<b>W10</b> COMBINATION UNIVERSAL SLIDING/FOLDING REPL PARTS 5-2216PPK2, 5-2238PPK2, 5-2136PPK1, 5-1836PPK1, 10-2376PPK2, 10-2378PPK2, 10-2336PPK2, 10-2338PPK2, 10-2135PPK1, 10-1832PPK3 10-1817PPK3, 10-1808PPK1, 10-2312PPK1, 10-1833PPK3	W10 W10MINI
	<b>W11</b> UNIVERSAL SLIDING DOOR REPLACEMENT PARTS 5-2216PPK2, 5-2238PPK2, 5-2136PPK1, 5-2156PPK3, 5-2155PPK1, 5-2312PPK1 5-15-3PPK3, 10-2376PPK1, 10-2378PPK1, 10-2336PPK1, 10-2338PPK1 10-2135PPK1	W11
	<b>W12</b> UNIVERSAL FOLDING DOOR REPLACEMENT PARTS 5-33--PPK2, 5-1836PPK1, 10-1832PPK3, 10-1817PPK3, 10-1808PPK1, 10-1823PPK2, 10-1703PPK2, 10-1805PPK2, 10-1833PPK3	W12

\*Mini Assortments include two of each item\*

# BUBBLE PACKED PARTS AND ACCESSORIES











KNOBSPULLS	PART #	Lbs./CT	LIST	KNOBSPULLS	PART #	LBS/CT	LIST
<b>15</b> 3/4" Round Brass Plated Steel Pull 4 per Pack 	15-3PPK3	.6/10	4 per Pack	<b>35</b> 1 3/8" x 3" Plated Steel Pull US3/US5/US15 Bright Brass/Ant. Brass/Sat. Nickel 	35-3PPK2 35-5PPK2 35-15PK2	1.4/10	2 per Pack
<b>21</b> 2 1/8" Plated Steel US3/US5/US15 Dummy Pull Bright Brass/Ant. Brass/Sat. Nickel 	21-3PPK2 21-5PPK2 21-15PK2	2/10	2 per Pack	<b>36</b> 1 3/4" Dia. Wood(Birch) Knob 	36--PPK2	1.3/10	2 per Pack
<b>30</b> 2 1/8" Plated Steel US3/US5/US15 Pull Bright Brass/Ant. Brass/Sat. Nickel 	30-3PPK2 30-5PPK2 30-15PK2	1.7/10	2 per Pack	<b>38</b> 1 1/2" Dia. Bright Brass Knob 	38-3PPK1	1.5/10	1 per Pack
<b>33</b> 1 3/4" Dia. Woodtone Styrene Knob 	33--PPK2	1.1/10	2 per Pack	<b>40</b> 1 3/8" x 3" Plated Steel Pull US3/US15 Bright Brass/Ant. Brass/Sat. Nickel 	40-3PPK2 40-15PK2	1.4/10	2 per Pack
				<b>150</b> Die Cast Bright Brass Finish Edge Pull US3 and US15 	150-3PK1 150-15P1	1.3/10	1 per Pack















# BUBBLE PACKED PARTS AND ACCESSORIES













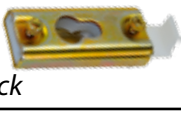
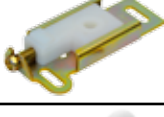

<b>107PIV-S</b> Pivot Set 	5.5/10 1 Set/Pk.	<b>1575PPK3</b> 1 3/4" Adpt. Kit 	3/10 1 Set/Pk.	<b>1832PPK3</b> Univ Pivot 	1.3/10 1 Set/Pk.	<b>2226PPK2</b> Hanger 1/16" Offset 	3.5/10 2 Ea./Pk.
<b>109PIV-S</b> Pivot Set 	9.1/10 1 Set/Pk.	<b>1606PLB2</b> Hinge Brown 	3.8/10 2 Ea./Pk.	<b>1833PPK3</b> Univ Snubber 	.8/10 1 Set/Pk.	<b>2228PPK2</b> Hanger 3/8" Offset 	3.7/10 2 Ea./Pk.
<b>118PIV-S</b> Pivot Set 	2.2/10 1 Set/Pk.	<b>1700PPK3</b> Bifold Hdwe 	4.8/10 1 Set/Pk.	<b>1836PPK1</b> Carpet Riser (FD) 	1.4/10 1 Ea./Pk.	<b>2238PPK2</b> Hanger 3/8" Offset 	2.6/10 2 Ea./Pk.
<b>119PIV-S</b> Pivot Set 	4/10 1 Set/Pk.	<b>1703PPK2</b> Hinge 	3.2/10 2 Ea./Pk.	<b>1875PLBG</b> Pivots 	1.4/10 1 Set/Pk.	<b>2255PLBG</b> 4 Dr. Stop Kit 	2/10 1 Set/Pk.
<b>209PIV-S</b> Pivot Set 	1.6/1 1 Set/Pk.	<b>1706PLB3</b> Pivots 	1.9/10 1 Set/Pk.	<b>2006PLBG</b> Wall Mount Bracket 	2.8/10 1 Ea./Pk.	<b>2312PPK1</b> Univ. Hngr. 7/8" Whl. 	3/10 1 Ea./Pk.
<b>1120PPK1</b> Hanger 1" Wheel 	7/10 1 Ea./Pk.	<b>1743PLBG</b> Hinge 	1.3/10 2 Ea./Pk.	<b>2041PLBG</b> Hidden PD Guide Kit 	10/10 1 Set/Pk.	<b>2336PPK2</b> Univ. V 1/16" Offset 3/4" Wheel 	2/10 2 Ea./Pk.
<b>1125PPK1</b> Ball Brg. 1" Wheel 	7/10 1 Ea./Pk.	<b>1805PPK2</b> Hinge 	2.4/10 2 Ea./Pk.	<b>2050PLBG</b> Conv. Door Kit 	10/10 1 Set/Pk.	<b>2338PPK2</b> Univ. V 3/8" Offset 3/4" Wheel 	2/10 2 Ea./Pk.
<b>1500PPK3</b> 1500 Hdwe. Set 	6.0/10 1 Set/Pk.	<b>1806PPK3</b> Pivot 	1.5/10 1 Set/Pk.	<b>2135PPK1</b> Guide 	1.3/10 1 Ea./Pk.	<b>2376PPK2</b> Univ. V 1/16" Offset 7/8" Wheel 	2/10 2 Ea./Pk.
<b>1505PPK3</b> Guide/ Bumper 	.7/10 1 Set/Pk.	<b>1808PPK1</b> Bifold Aligner 	1.2/10 1 Set/Pk.	<b>2136PPK1</b> Carpet Riser (SD) 	1.8/10 1 Ea./Pk.	<b>2378PPK2</b> Univ. V 3/8" Offset 7/8" Wheel 	2.2/10 2 Ea./Pk.
<b>1506PLB2</b> Hinges 	2.7/10 2 Ea./Pk.	<b>1817PPK3</b> Bottom Pivot 	2/10 1 Set/Pk.	<b>2155PPK1</b> Bumper 	.8/10 1 Ea./Pk.	<b>2511PPK3</b> Hdwe. Set 	6/10 1 Set/Pk.
<b>1555PPK3</b> Converge Door Kit 	5.5/10 1 Set/Pk.	<b>1823PPK2</b> Hinge 	2.3/10 2 Ea./Pk.	<b>2156PPK3</b> Guide/ Riser Set 	3/10 1 Set/Pk.	<b>2802PLB2</b> Hangers 	3.7/10 2 Ea./Pk.
		<b>1825PLBG</b> Bifold Hdwe 	3.6/10 1 Set/Pk.	<b>2216PPK2</b> Hanger 1/16" Offset 	2.5/10 2 Ea./Pk.		



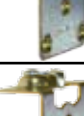









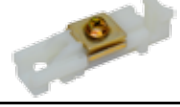

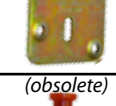
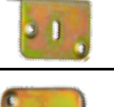
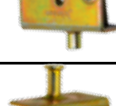
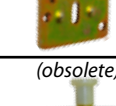
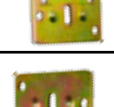

Bulk Part #		Pkg Lbs.
<b>10</b> Guide		100 1.7
<b>11</b> Guide		100 1.5
<b>12</b> Guide		25 1.1
<b>13</b> Plug		100 1.0
<b>14US3</b> 2 1/8" Pull Brt. Brass		100 2.7
<b>15US3</b> 3/4" Pull Brt. Brass		100 0.7
<b>15US15</b> 3/4" Pull Sat. Nickel		100 0.7
<b>20</b> 1 3/4" Pull Br. Plastic. <small>(Obsolete)</small>		100 1.5
<b>21US3</b> 2 1/8" Pull Brt. Brass		25 1.4
<b>21US5</b> 2 1/8" Pull Ant. Brass		25 1.4
<b>21US15</b> 2 1/8" Pull Sat. Nickel		25 1.4
<b>30US3</b> 2 1/8" Pull Brt. Brass		100 5.4
<b>30US5</b> 2 1/8" Pull Ant. Brass		100 5.4
<b>30US15</b> 2 1/8" Pull Sat. Nickel		100 5.4
<b>32</b> Knob Acrylic		25 1.3







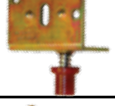
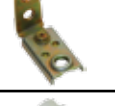
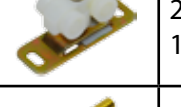
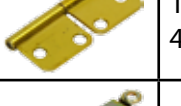
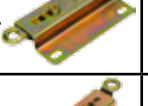
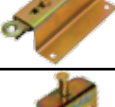
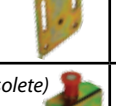
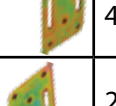
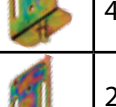







Bulk Part #		Pkg Lbs.
<b>33</b> Knob Brown		100 3.0
<b>35US3</b> Pull Brt. Brass		50 2.1
<b>35US5</b> Pull Ant. Brass		50 2.1
<b>35US15</b> Pull Sat. Nickel		50 2.1
<b>36</b> Knob Wood		100 3.6
<b>37</b> Knob White		100 3.0
<b>38</b> Knob Brt. Brass		100 4.7
<b>40US3</b> Pull Brt. Brass		50 2.2
<b>40US5</b> Pull <small>(obsolete)</small> Ant. Brass		50 2.2
<b>40US15</b> Pull Sat. Nickel		50 2.2
<b>101</b> Univ. Guide		50 2.3
<b>150US3</b> Edge Pull Brt. Brass		25 2.0
<b>150US15</b> Edge Pull Sat. Nic.		25 2.0
<b>1001</b> Top Pivot		25 5.0
<b>1002</b> 1 1/8" Door Top Pivot		25 7.5

Bulk Part #		Pkg Lbs.
<b>1003</b> 1 3/8" Door Top Pivot		25 7.5
<b>1004</b> 1 3/4" Door Top Pivot		25 7.5
<b>1010</b> Pivot Lock		25 8.0
<b>1011</b> Floor Bracket		25 9.0
<b>1020</b> Hanger 3/4" Wheel		50 6.0
<b>1021</b> <small>(1020/1025 Door Plate)</small>		100 4.5
<b>1023</b> 1020 Saddle Brckt. For 3/4" Doors		50 3.3
<b>1025</b> Ball-Bearing 3/4" Wheel		50 7.0
<b>1120</b> Hanger 1" Wheel		50 12
<b>1121</b> <small>(1120/1125 Door Plate)</small>		100 8.0
<b>1122</b> <small>(1 1/8" door Door Plate)</small>		25 7.2
<b>1123</b> <small>(1 3/8" door Door Plate)</small>		25 7.2
<b>1124</b> <small>(1 3/4" door Door Plate)</small>		25 7.2
<b>1125</b> Ball-Bearing 1" Wheel		50 16
<b>1126</b> <small>(1 1/8" door Side Mount)</small>		25 11



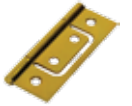



Bulk Part #		Pkg Lbs.
<b>1127</b> <i>(1 3/8" door Side Mount)</i>		25 11
<b>1128</b> <i>(1 3/4" door Side Mount)</i>		25 11
<b>1155</b> <i>Track Stop</i>		100 3.8
<b>1461</b> <i>Bottom Piv Socket</i>		50 2.5
<b>1506</b> <i>Hinge</i>		50 5.4
<b>1513</b> <i>Bumper</i>		100 1.0
<b>1550</b> <i>Guide</i>		100 2.5
<b>1602</b> <i>White Drywall Hinge</i>		50 10
<b>1605</b> <i>Brown Drywall Hinge</i>		50 10
<b>1603</b> <i>White Hinge</i>		50 8.2
<b>1606</b> <i>Brown Hinge</i>		50 8.2
<b>1701</b> <i>Top Pivot</i>		100 5.4
<b>1702</b> <i>Top Guide</i> <i>(obsolete)</i>		100 5.5
<b>1703</b> <i>Hinge</i>		100 14
<b>1704</b> <i>3/4" Floor Bracket</i>		25 4.2





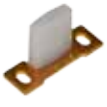





Bulk Part #		Pkg Lbs.
<b>1705</b> <i>Guide</i>		100 5.5
<b>1706</b> <i>Bot. Pivot Long</i>		100 5.3
<b>1707</b> <i>Bottom Pivot</i>		100 4.8
<b>1710</b> <i>Pivot Lock</i>		50 2.7
<b>1711</b> <i>Jamb Bracket</i>		50 8.2
<b>1712</b> <i>Adjusting Wrench</i>		100 2.5
<b>1713</b> <i>Snubber</i>		100 2.6
<b>1714</b> <i>1 1/4" Floor Bracket</i>		25 5.5
<b>1721</b> <i>Top Pivot 3/4" Doors</i>		25 3.1
<b>1722</b> <i>Top Guide 3/4" Doors</i> <i>(obsolete)</i>		25 3.0
<b>1723</b> <i>Bot. Pivot 3/4" Doors</i>		25 2.9
<b>1724</b> <i>Top Pivot 1 1/8" Doors</i>		25 3.2
<b>1726</b> <i>Top Guide 1 1/8" Doors</i> <i>(obsolete)</i>		25 3.2
<b>1727</b> <i>Bot. Pivot 1 1/8" Doors</i>		25 3.0
<b>1728</b> <i>Top Pivot 1 3/8" Doors</i>		25 3.3







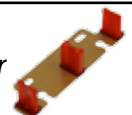

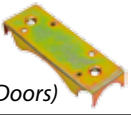
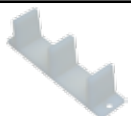

Bulk Part #		Pkg Lbs.
<b>1729</b> <i>Top Guide 1 3/8" Doors</i> <i>(obsolete)</i>		25 3.3
<b>1730</b> <i>Bot. Pivot 1 3/8" Doors</i>		25 3.2
<b>1731</b> <i>Bot. Guide 3/4" Doors</i>		25 3.2
<b>1732</b> <i>Bot. Guide 1 1/8" Doors</i>		25 3.2
<b>1733</b> <i>Bot. Guide 1 3/8" Doors</i>		25 3.4
<b>1741</b> <i>Shutter Bracket</i>		25 2.6
<b>1742</b> <i>Shutter Hanger</i>		25 1.1
<b>1743</b> <i>Shutter. Hinge</i>		100 4.6
<b>1744</b> <i>3/4" High Dbl. Floor Brckt</i>		25 8.2
<b>1754</b> <i>1 1/4" High Dbl. Floor Brckt</i>		25 11
<b>1771</b> <i>Top Pivot 3/4" Sidemount</i>		25 4.3
<b>1772</b> <i>Top Guide 3/4" Sidemount</i> <i>(obsolete)</i>		25 4.3
<b>1773</b> <i>Bot. Pivot 3/4" Sidemount</i>		25 4.2
<b>1774</b> <i>Bot. Guide 3/4" Sidemount</i>		25 4.6
<b>1775</b> <i>Doorkeeper</i>		25 1.4







Bulk Part #		Pkg Lbs.
<b>1801</b> <i>7/16" dia Top Pivot/Guide.</i>		100 3.6
<b>1804</b> <i>Floor Bracket</i>		25 2.0
<b>1805</b> <i>Hinge</i>		100 8.5
<b>1807</b> <i>7/16" Dia Bot. Pivot.</i>		100 4.4
<b>1808</b> <i>4-Door Aligner</i>		100 7.5
<b>1810</b> <i>Pivot Socket</i>		50 2.8
<b>1811</b> <i>Jamb Bracket</i>		50 5.0
<b>1812</b> <i>Snubber 2 Door</i>		100 1.2
<b>1814</b> <i>Snubber 4 Door</i>		100 1.7
<b>1815</b> <i>Hinge</i>		100 8.0
<b>1823</b> <i>Hinge</i>		100 9.3
<b>1831</b> <i>3/8" dia Top Pivot/Guide</i>		100 3.5
<b>1836</b> <i>Carpet Riser</i>		25 2.3
<b>1837</b> <i>3/8" Dia Bot. Pivot</i>		100 4.3
<b>1861</b> <i>Jamb Bracket</i>		50 2.5

Bulk Part #		Pkg Lbs.
<b>1922</b> <i>Top Guide 3/4" Doors</i>		25 3.1
<b>1926</b> <i>Top Guide 1 1/8" Doors</i>		25 3.5
<b>1929</b> <i>Top Guide 1 3/8" Doors</i>		25 3.5
<b>1972</b> <i>Top Guide 3/4" Sidemount</i>		25 4.4
<b>2001</b> <i>Top Pivot Bifold</i>		25 6.0
<b>2002</b> <i>Bifold Guide</i>		25 23
<b>2003</b> <i>Ball Bearing Hinge (pair)</i>		10 pr. 8.5
<b>2004</b> <i>1 3/8" Side Mnt Bifold Hanger</i>		25 25
<b>2005</b> <i>1 3/4" Side Mnt Bifold Hanger</i>		25 25
<b>2007</b> <i>Bot. Piv Bifold.</i>		25 10
<b>2008</b> <i>2 1/4" Side Mnt Bifold Hanger</i>		25 25
<b>2010</b> <i>Pivot Lock</i>		25 10
<b>2011</b> <i>Floor Bracket</i>		25 9.0
<b>2016</b> <i>1 3/8" Side Mnt Bifold Plate</i>		25 12
<b>2017</b> <i>1 3/4" Side Mnt Bifold Plate</i>		25 12

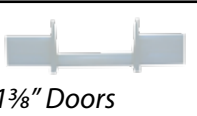
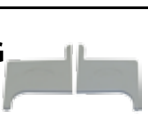
Bulk Part #		Pkg Lbs.
<b>2018</b> <i>2 1/4" Side Mnt Bifold Plate</i>		25 12
<b>2020</b> <i>Hanger Sliding Door</i>		25 29
<b>2022</b> <i>1 3/8" Side Mnt Hanger</i>		30 25
<b>2023</b> <i>1 3/4" Side Mnt Hanger</i>		30 25
<b>2024</b> <i>2 1/4" Side Mnt Hanger</i>		30 25
<b>2030</b> <i>Heavy Duty Slender Guide</i>		25 2.6
<b>2031</b> <i>Heavy Duty Single Guide</i>		25 6.0
<b>2032</b> <i>Side Mount 1 3/8 DR Guide</i>		25 4.9
<b>2033</b> <i>Side Mount 1 3/4 DR Guide</i>		25 4.9
<b>2034</b> <i>Guide 1 3/4" Doors</i>		25 12
<b>2035</b> <i>Guide 1 3/8" Doors</i>		25 12
<b>2036</b> <i>Side Mount 2 1/4 DR Guide</i>		25 4.9
<b>2037</b> <i>Guide 1 3/4" Doors</i>		50 13
<b>2038</b> <i>Guide 1 3/8" Doors</i>		50 13
<b>2040</b> <i>Rout Groove Cover</i>		25 1.3

Bulk Part #		Pkg Lbs.
<b>2042</b> 1 $\frac{3}{8}$ " Side Mnt Plate		25 11
<b>2043</b> 1 $\frac{3}{4}$ " Side Mnt Plate		25 11
<b>2044</b> 2 $\frac{1}{4}$ " Side Mnt Plate		25 11
<b>2054PLBG</b> Mult-Door Pull Catch		10 1.5
<b>2055</b> Track Stop		25 9.0
<b>2056</b> 2020 Hgr. Retainer		25 9.0
<b>2083</b> Guide Finished Floor		25 1.5
<b>2084</b> Guide Subfloor		25 1.8
<b>2118</b> Nylon Guide 1 $\frac{1}{8}$ " Doors		25 2.2
<b>2134</b> Guide 1 $\frac{1}{8}$ " or 1 $\frac{3}{4}$ " Doors		25 2.4
<b>2135</b> Guide $\frac{3}{4}$ " or 1 $\frac{3}{8}$ " Doors		100 7.5

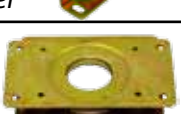
Bulk Part #		Pkg Lbs.
<b>2136</b> Carpet Riser (Sliding Doors)		100 4.8
<b>2138</b> Nylon Guide 1 $\frac{3}{8}$ " Doors		100 1.6
<b>2155</b> Door Stop		50 1.6
<b>2165</b> Track Stop		100 4.4
<b>2175</b> Guide $\frac{3}{4}$ " Doors		25 1.8
<b>2206</b> Univ. Hanger. $\frac{1}{16}$ " Offset		100 7.1
<b>2208</b> Univ. Hanger. $\frac{3}{8}$ " Offset		100 7.1
<b>2216</b> Hanger. $\frac{1}{16}$ " Offset		100 9.7
<b>2226</b> Hanger. $\frac{1}{16}$ " Offset		50 7.4
<b>2228</b> Hanger. $\frac{3}{8}$ " Offset		50 8.0
<b>2238</b> Hanger. $\frac{3}{8}$ " Offset		100 11

Bulk Part #		Pkg Lbs.
<b>2312</b> Univ. Hanger $\frac{7}{8}$ " Whl-V Trk		50 11
<b>2551</b> Pocket Guide 1 $\frac{3}{8}$ " Doors		50 1.2
<b>2680PLBG</b> End Caps		50 2.3
<b>2682PLBG</b> End Caps		50 2.3
<b>2802</b> Hanger $\frac{7}{8}$ " Wheel		50 7.6
<b>2812</b> Hanger $\frac{7}{8}$ " Wheel		50 12
<b>2815</b> Ball-Bearing $\frac{7}{8}$ " Wheel		50 13
<b>8050</b> Swivel Bracket		50 22
<b>9027</b> 1 $\frac{3}{8}$ " Rod Support		50 8.5
<b>9028</b> 1" Rod Support		50 8.2

Johnson Hardware  
2100 Sterling Ave.  
Elkhart, IN 46516  
PH: 800-837-5664  
Fax: 800-837-4697