

LIN-DI

LED LINEAR
DIRECT/INDIRECT LINEAR LIGHTING



Fixture Type
Project
Notes



Field Adjustable CCT
3000K-3500K-4000K

JESCO's LIN Series is a versatile linear lighting system with a modern aesthetic, offering a uniform light distribution that meets a variety of design needs, whether the project calls for pendant mounting, surface mounting, wall mounting or a combination thereof. The LIN Series of extra-rigid sleek aluminum housing in 8ft, 4ft and 2ft lengths, may be easily connected to form long linear runs.

Straight runs can be combined with preassembled lit-connectors in X, L and T configurations to create intricate patterns and forms. An easily accessible, on-board, CCT toggle switch allows users to select, and later change, between 3000K/3500K/4000K color temperatures. An opal polycarbonate lens offers perfect diffusion.

120 - 277V AC
 140° INDIRECT / 110° DIRECT BEAM
 0-10V DIMMABLE
 AI POWER COATED
 INDOOR DRY
 L70 50,000 HOURS
 5 YEAR WARRANTY
 DLC LISTED
 ETL LISTED US Intertek

SPECIFICATIONS

INPUT VOLTAGE	Universal 120-277V AC
WATTAGE	24 - 20W 48 - 40W 72 - 60W 96 - 80W
LUMENS	Up to 1319 Lm/ft @ 3500K
CRI	90+
BEAM ANGLE	DIRECT: 110° INDIRECT: 140° batwing
DIMMING¹	0-10V, RF see page 7
	CASAMBI READY see page 8

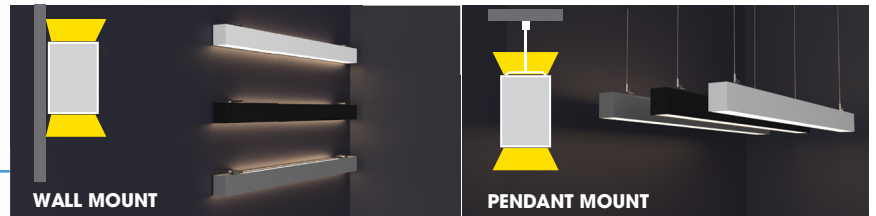

DIMENSIONS	2 1/2" W x 3 3/8" H 63mm W x 88mm H
LENGTH OPTIONS	24 - 24 1/2" 48 - 47 1/4" 72 - 70 7/8" 96 - 94 1/2"
MAX CONNECTED LENGTH	120V - 80Ft / 277V - 184Ft
ENVIRONMENT	Indoor - Dry
CERTIFICATIONS	cETLus Listed
WARRANTY²	5 Years

¹ Effectively dim down to 5% on linear runs, 10% on runs with lit connectors.
² See published warranty terms for detailed information

PERFORMANCE

CCT ³	24 -20W		48 -40W		72 -60W		96 -80W		EFFICACY	CRI
	DIRECT	INDIRECT	DIRECT	INDIRECT	DIRECT	INDIRECT	DIRECT	INDIRECT		
3000K	1895 Lm	683 Lm	3790 Lm	1365 Lm	5805 Lm	1935 Lm	7580 Lm	2730 Lm	129 Lm/W	90+
3500K	1915 Lm	723 Lm	3830 Lm	1446 Lm	5940 Lm	1980 Lm	7660 Lm	2982 Lm	132 Lm/W	90+
4000K	1879 Lm	695 Lm	3757 Lm	1390 Lm	5805 Lm	1935 Lm	7514 Lm	2780 Lm	129 Lm/W	90+
2700K ⁴	1890 Lm	630 Lm	3780 Lm	1260 Lm	5670 Lm	1890 Lm	7560 Lm	2520 Lm	126 Lm/W	90+
5000K ⁴	1950 Lm	650 Lm	3900 Lm	1300 Lm	5850 Lm	1950 Lm	7880 Lm	2600 Lm	130 Lm/W	90+

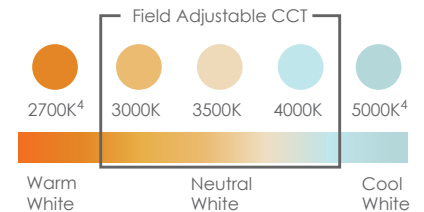

³ CCT within +/-10%

ORDERING INFO

SERIES LIN-DI	LENGTH 24 - 2FT 20W 48 - 4FT 40W 72 - 6FT 60W 96 - 8FT 80W	CCT DSW1 - 3000K/3500K/4000K selectable D2700 ⁴ - 2700K 90CRI D5000 ⁴ - 5000K 90CRI	LENS OP - OPAL	FINISH WH - WHITE BK - BLACK SV - SILVER
SERIES LIN-DI	LIT CONNECTOR L - 90° L SHAPED T - 2 x 90° T SHAPED X - 4 x 90° X SHAPED V ⁴ - 120° V SHAPED Y - 3 x 120° Y SHAPED	CCT DSW1 - 3000K/3500K/4000K selectable D2700 ⁴ - 2700K 90CRI D5000 ⁴ - 5000K 90CRI	LENS OP - OPAL	FINISH WH - WHITE BK - BLACK SV - SILVER

⁴ Consult factory on lead time

OPTIONAL REMOTE EMERGENCY BATTERY
EM-LIN [see Page 6 for details](#)

OPTIONAL ROLLABLE LENS
LIN-LC-OP - [see page 6 for details](#)
1Ft increments up to 80Ft

MOUNTING ACCESSORIES
[See Page 3 for details](#)

LIN-DI

LED LINEAR
DIRECT/INDIRECT LINEAR LIGHTING



Fixture Type
Project
Notes

DIMENSIONAL DRAWING

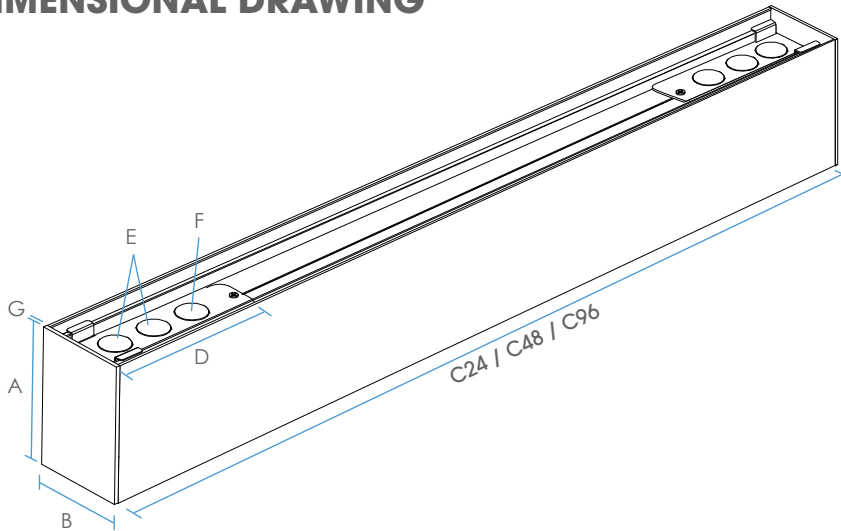

DIMENSIONS

A	3 3/16"	88mm Height
B	2 1/2"	63mm Width
C24	24 3/16"	614mm
C48	47 1/4"	1200mm
C96	94 1/2"	2400mm
D	4 5/16"	110mm Knockout plate length
E	Trade size 3/8" Knockout	
F	Trade size 1/2" Knockout	
G	1/8"	3.7mm Thickness of endcap

PHOTOMETRIC 3500K 48in. SAMPLE

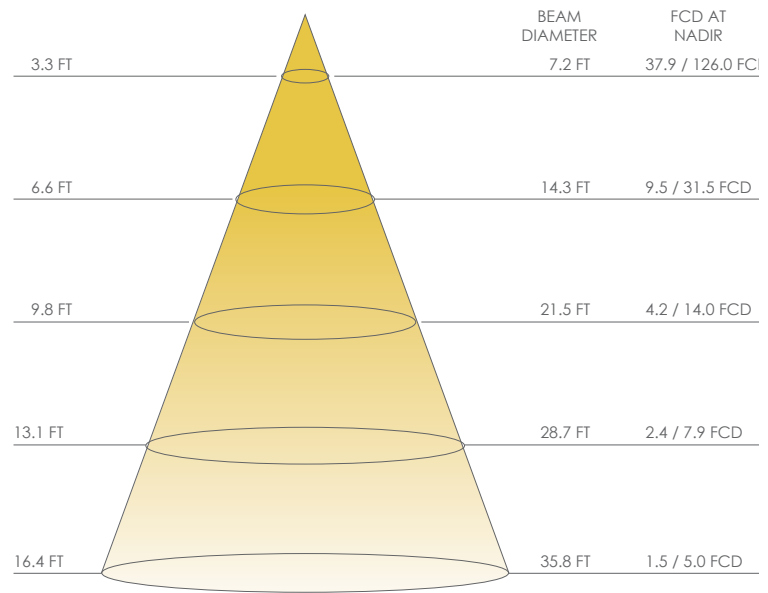
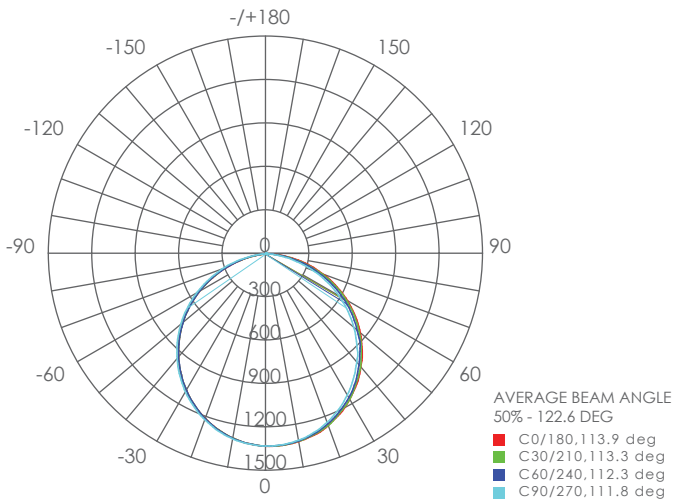

TM30-15 3500K 48in. Sample

CRI (Re) (R1-R15) Ra = 94.7 AvgR = 91.6

R1	96	R6	96	R11	97
R2	97	R7	94	R12	78
R3	96	R8	86	R13	96
R4	97	R9	66	R14	97
R5	95	R10	91	R15	92

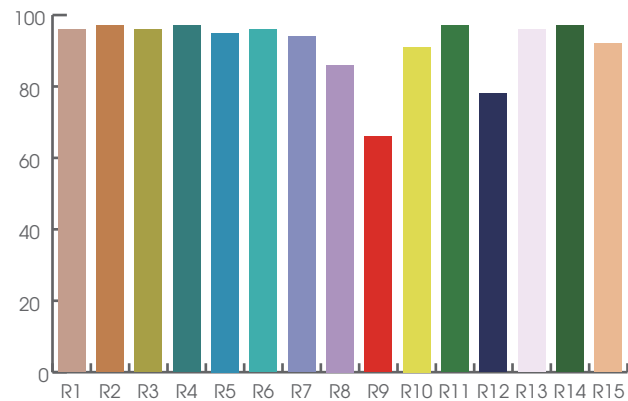

Fixture Type
Project
Notes

LIT CONNECTORS

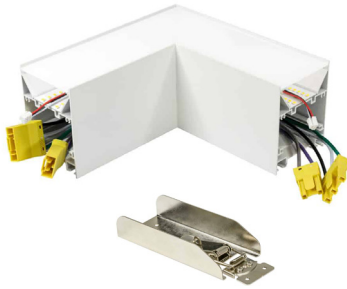

	SHAPE	CCT	LENS	FINISH
PART NUMBER	LIN - D - L - [] - OP - []			
DESCRIPTION	90° L Shaped Lit Connector			
LUMEN	660 Lm			
ENVIRONMENT	Indoor, Dry			
DIMENSIONS	A 3 3/16" (88 mm)	B 2 1/2" (63 mm)	C 4 7/16" (113 mm)	D 6 15/16" (176 mm) E 6 15/16" (176 mm)

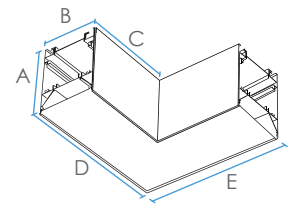

LIN-JBR 1 included

Metal support bracket with latch & hook locking mechanism

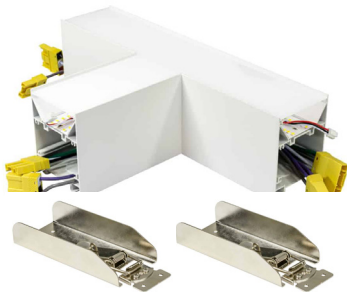

	SHAPE	CCT	LENS	FINISH
PART NUMBER	LIN - D - T - [] - OP - []			
DESCRIPTION	2 x 90° T Shaped Lit Connector			
LUMEN	1000 Lm			
ENVIRONMENT	Indoor, Dry			
DIMENSIONS	A 3 3/16" (88 mm)	B 2 1/2" (63 mm)	C 4 7/16" (113 mm)	D 6 15/16" (176 mm) E 11 3/8" (289 mm)

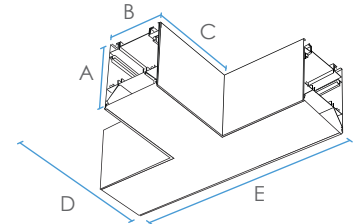

LIN-JBR 2 included

Metal support bracket with latch & hook locking mechanism

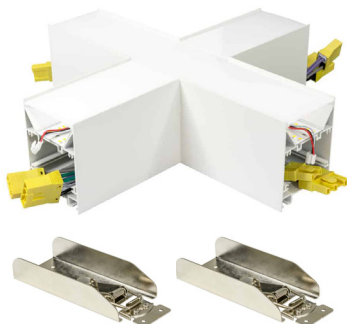

	SHAPE	CCT	LENS	FINISH
PART NUMBER	LIN - D - X - [] - OP - []			
DESCRIPTION	4 x 90° X Shaped Lit Connector			
LUMEN	1320 Lm			
ENVIRONMENT	Indoor, Dry			
DIMENSIONS	A 3 3/16" (88 mm)	B 2 1/2" (63 mm)	C 4 7/16" (113 mm)	D 11 3/8" (289 mm) E 11 3/8" (289 mm)

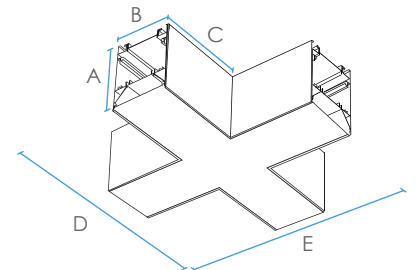

LIN-JBR 2 included

Metal support bracket with latch & hook locking mechanism

Fixture Type
Project
Notes

LIT CONNECTORS ... continued

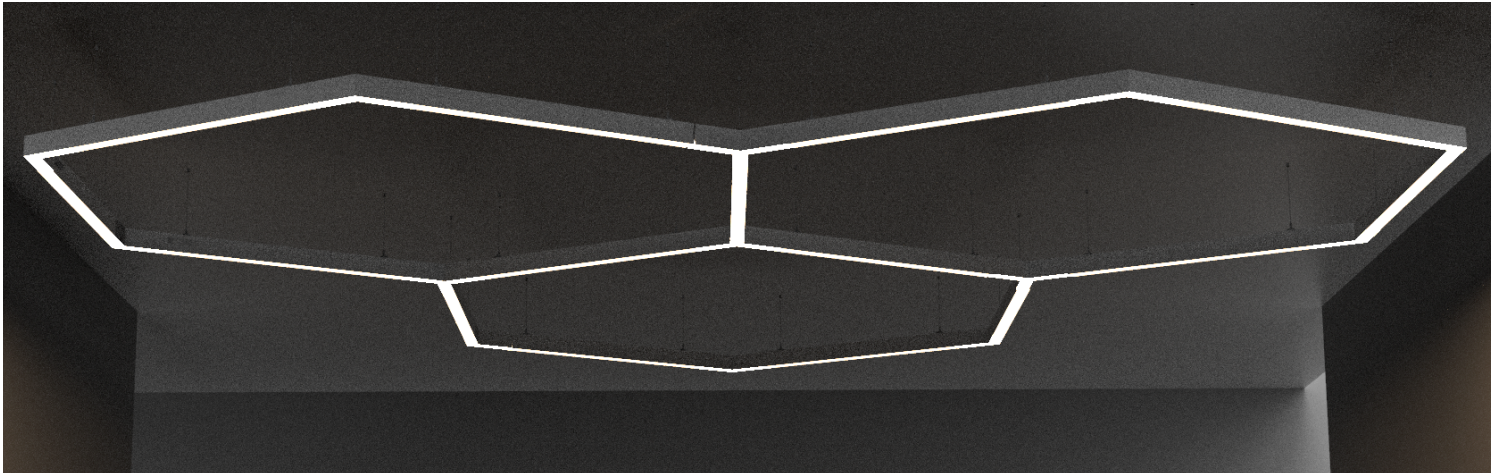

	SHAPE	CCT	LENS	FINISH
PART NUMBER	LIN - D - V -		OP -	
DESCRIPTION	120° V Shaped Lit Connector			
LUMEN	660 Lm			
ENVIRONMENT	Indoor, Dry			
DIMENSIONS	A 3 3/16" (88mm)	B 2 1/2" (63 mm)	C 4 7/16" (113 mm)	D 6 5/16" (160 mm) E 8 3/4" (223 mm)

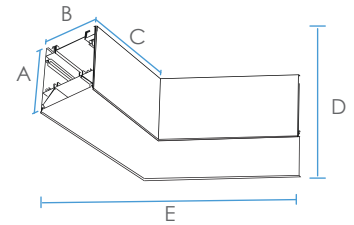

LIN-JBR 1 included

Metal support bracket with latch & hook locking mechanism



	SHAPE	CCT	LENS	FINISH
PART NUMBER	LIN - D - Y -		OP -	
DESCRIPTION	120° Y Shaped Lit Connector			
LUMEN	1000 Lm			
ENVIRONMENT	Indoor, Dry			
DIMENSIONS	A 3 3/16" (88 mm)	B 2 1/2" (63 mm)	C 4 7/16" (113 mm)	D 4 7/16" (113 mm)

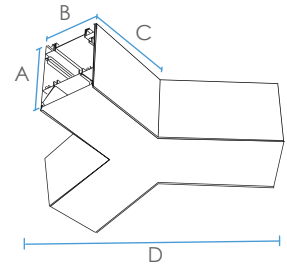

LIN-JBR 2 included

Metal support bracket with latch & hook locking mechanism

Fixture Type
Project
Notes

MOUNTING ACCESSORIES PENDANT MOUNT

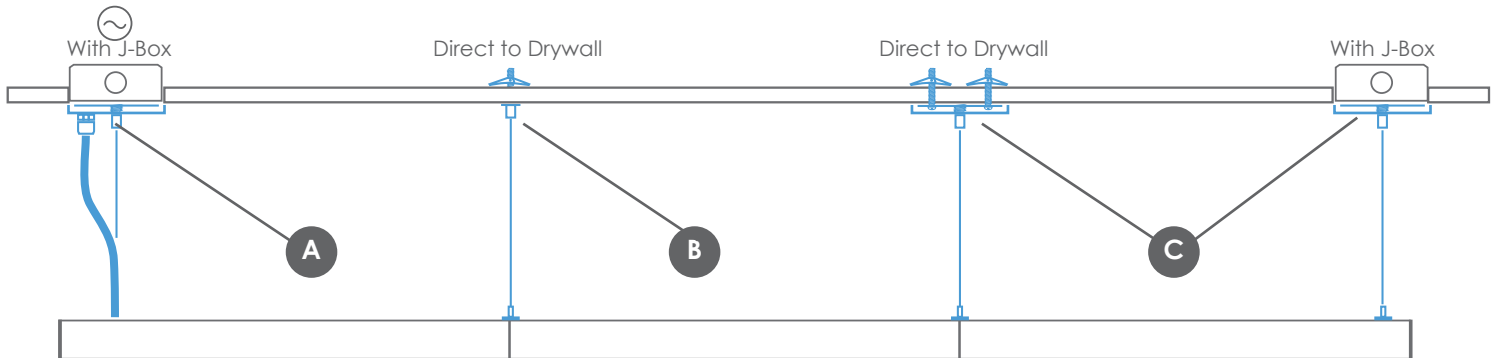

A



LIN-PD-KIT-PF-WH-8FT

Pendant mounting kit with power feed canopy and mounting accessories. White canopy, cord 8Ft air-craft cable and cord. Indoor, Dry.

LIN-PD-KIT-PF-WH-20FT

Pendant mounting kit with power feed canopy and mounting accessories. White canopy, cord 20Ft air-craft cable and cord. Indoor, Dry.

LIN-PD-KIT-PF-BK-8FT

Pendant mounting kit with power feed canopy and mounting accessories. Black canopy, cord 8Ft air-craft cable and cord. Indoor, Dry.

LIN-PD-KIT-PF-BK-20FT

Pendant mounting kit with power feed canopy and mounting accessories. Black canopy, cord 20Ft air-craft cable and cord. Indoor, Dry.

B



LIN-PD-KIT-DC-8FT

Pendant direct mounting kit 8Ft air-craft cable Indoor, Dry.

LIN-PD-KIT-DC-20FT

Pendant direct mounting kit 20Ft air-craft cable Indoor, Dry.

C



LIN-PD-KIT-NF-WH-8FT

Pendant mounting kit with non-power canopy and mounting accessories. White canopy, cord 8Ft air-craft cable and cord. Indoor, Dry.

LIN-PD-KIT-NF-WH-20FT

Pendant mounting kit with non-power canopy and mounting accessories. White canopy, cord 20Ft air-craft cable and cord. Indoor, Dry.

LIN-PD-KIT-NF-BK-8FT

Pendant mounting kit with non-power canopy and mounting accessories. Black canopy, cord 8Ft air-craft cable and cord. Indoor, Dry.

LIN-PD-KIT-NF-BK-20FT

Pendant mounting kit with non-power canopy and mounting accessories. Black canopy, cord 20Ft air-craft cable and cord. Indoor, Dry.

POWER FEED CABLE
18/5 AWG WIRE



Fixture Type
Project
Notes

MOUNTING ACCESSORIES WALL MOUNT

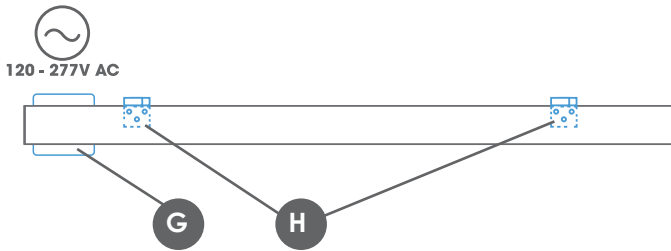

POWER FEED CABLE
18/5 AWG WIRE

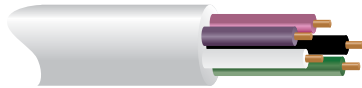

G

LIN-SM-KIT-PF-WH

Surface mount power-feed kit with 2Ft.
White cord, white cover plate. Indoor, Dry.

H

LIN-WS-KIT

Universal 9/16, 15/16. T-Bar recessed
mounting kit. Indoor, Dry.



REMOTE EMERGENCY BATTERY

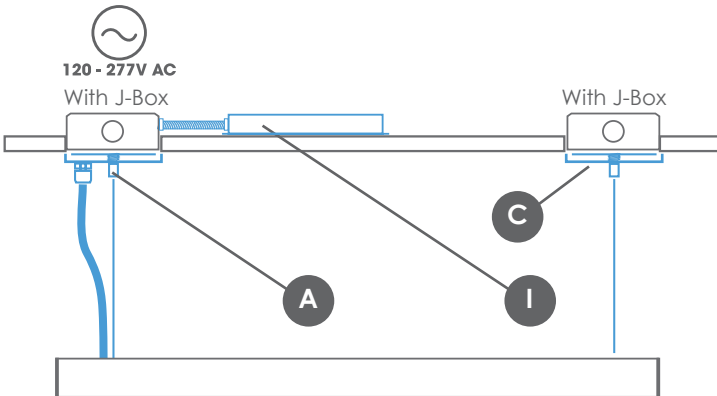

I

EM-LIN

Remote emergency battery back up with remote tester.



LIN-DI

LED LINEAR
DIRECT/INDIRECT LINEAR LIGHTING



Fixture Type
Project
Notes

RF DIMMING

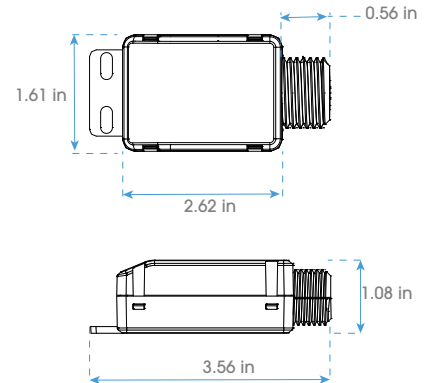
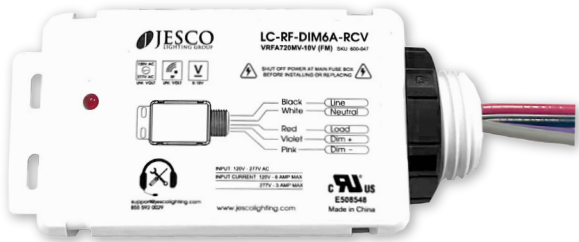

MODEL	LC-RF-DIM6A-HW-RCV
DESCRIPTIONS	0-10V RF Hardwire Receiver
INPUT VOLTAGE	120V - 277V AC
INPUT CURRENT MAX	120V - 6A / 277V - 3A
STAND BY POWER	<1W
OUTPUT POWER MAX	120V - 720W / 277V - 831W
LIN SERIES DIRECT	120V - 80FT / 277V - 100FT
LIN SERIES DIRECT/INDIRECT	120V - 60FT / 277V - 70FT
AMBIENT TEMPERATURE, ta	-4F° - 113F°
STORAGE TEMPERATURE	-13F° - 131F°
MAX. RELATIVE HUMIDITY	0-75%, non condensing
ENVIRONMENT	Indoor, Dry IP20

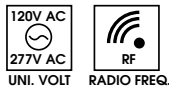
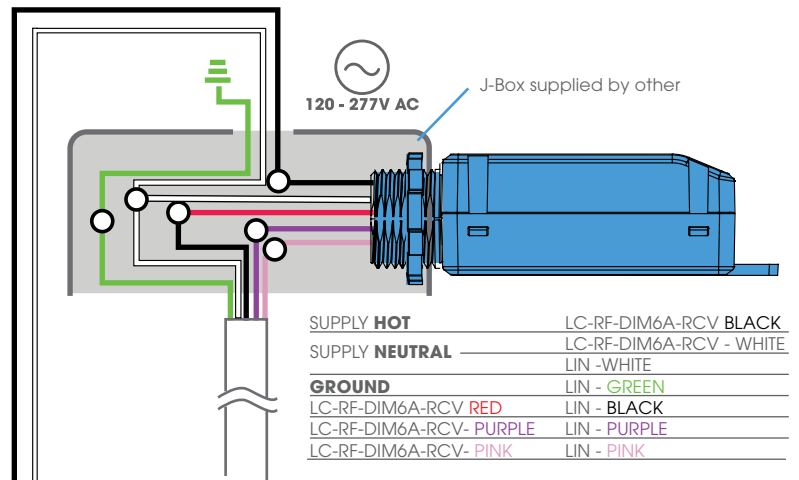

MODEL	LC-RF-DIM6A-W
DESCRIPTIONS	0-10V RF Wall Dimming Switch
INPUT VOLTAGE	120V - 277V AC
INPUT CURRENT MAX	120V - 6A / 277V - 3A
CHARGING OUTPUT	5V DC, 60mA
OPERATING RANGE	25 Ft
ENVIRONMENT	Indoor, Dry IP20

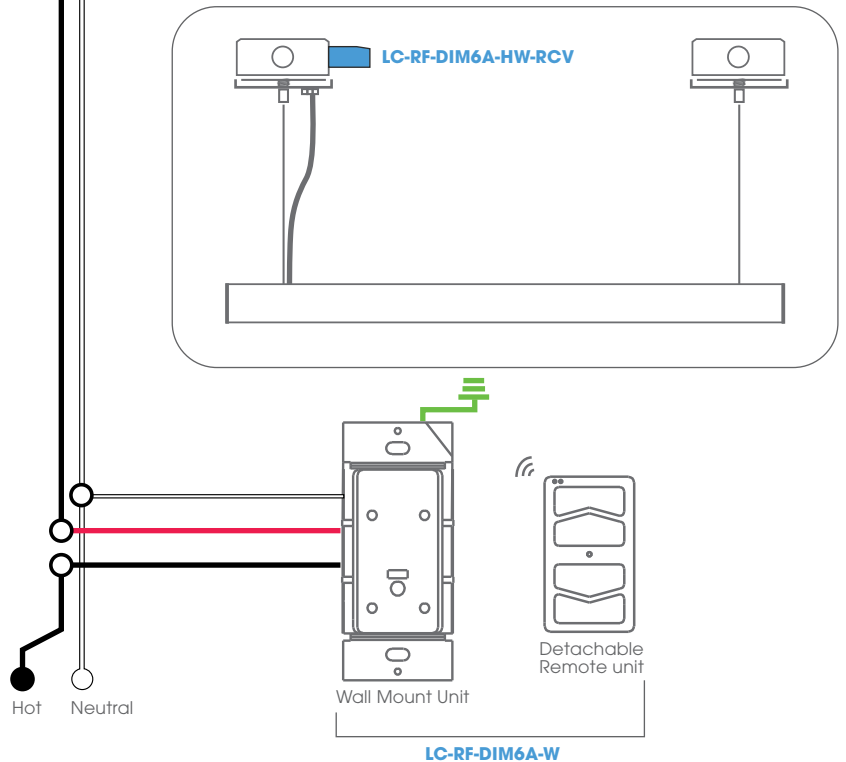

LIN-DI

LED LINEAR
DIRECT/INDIRECT LINEAR LIGHTING



Fixture Type
Project
Notes

CASAMBI READY

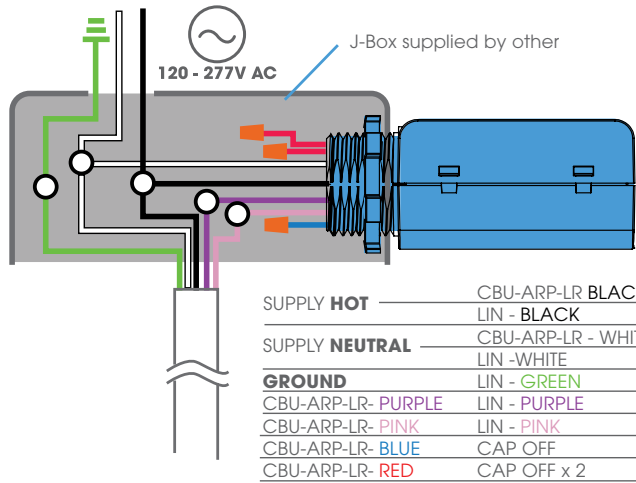
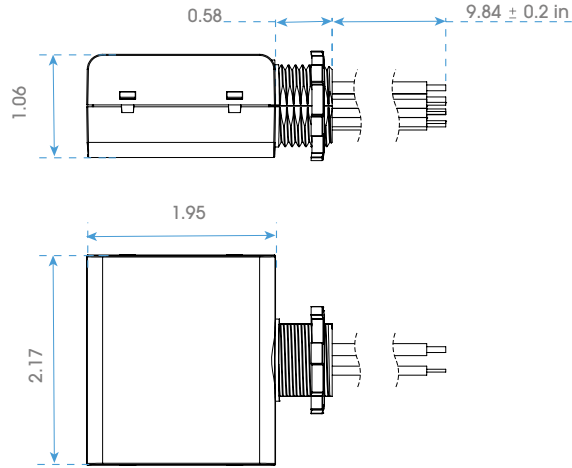
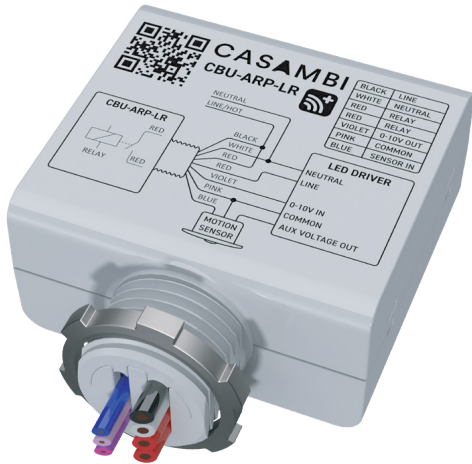

MODEL	CBU-ARP-LR supply by other
RATED POWER	120V 240W
	277V 554W
RATED CURRENT	2A
INPUT	120-277V AC
RELAY CONTACT RATING	120-277V AC
CONTROL OUTPUT	0-10V DC, max 7mA
OPERATING FREQUENCIES	2400-2480 MHz
MAX. OUTPUT POWER	+4dBm
NO-LOAD STANDBY POWER	< 0.5W
AMBIENT TEMPERATURE, t_a	-4F° - 113F°
MAX. CASE TEMPERATURE, t_c	158F°
STORAGE TEMPERATURE	-13F° - 158F°
MAX. RELATIVE HUMIDITY	0-80%, non condensing
ENVIRONMENT	Indoor, Dry IP20
WIRE GAUGE INPUT/OUTPUT	14-22AWG Solid or Stranded
WIRE STRIP LENGTH	0.2"
TIGHTENING FORCE	0.4Nm
MAX. INPUT CABLE LENGTH	10 Ft
MAX. LOAD CABLE LENGTH	10 Ft
WEIGHT	110 g

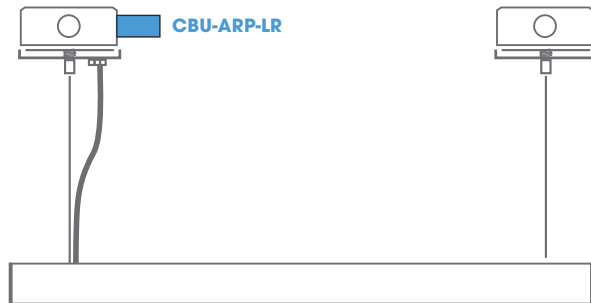

MAX CONNECTED RUN LENGTH	120V DIRECT - 80 Feet
	120V DIRECT/INDIRECT - 60 Feet
	277V DIRECT - 80 Feet
	277V DIRECT/INDIRECT - 60 Feet