



ADJUSTABLE-SHELF

Specification:

1. Material: MDF + Plywood + Birch
2. Finish: See Table
3. Hardware: See Table
4. Slides: USE58-300-18 + USCLIP2ND-4W( 7 Set )
5. Hinge: 700.0536.25 + 600.1234.05 ( 4 Set )
6. Shelf Supports: 1707BN ( 4 PCS )
7. The tolerance is +/- 1/8"

Item number	Finish	Deco Hardware	
		Item number	Qty
VN2THE-48-BK-NT	Black	PC, vendor's item	8
VN2THE-48-BL-NT	Blue	SBZ, vendor's item	8
VN2THE-48-BS-NT	Blue Steel	PC, vendor's item	8
VN2THE-48-GN-NT	Green	SBZ, vendor's item	8
VN2THE-48-GR-NT	Grey	PC, vendor's item	8
VN2THE-48-WH-NT	White	PC, vendor's item	8

 <p><b>PROPRIETARY AND CONFIDENTIAL</b></p> <p>THE INFORMATION CONTAINED IN THIS DRAWING IS THE SOLE PROPERTY OF HARDWARE RESOURCES INC. ANY REPRODUCTION IN PART OR AS A WHOLE WITHOUT THE WRITTEN PERMISSION OF HARDWARE RESOURCES INC. IS PROHIBITED.</p>	ITEM#: VN2THE-48	MATERIAL:	
	FINISH:	WEIGHT: 9	
	TOLERANCE UNLESS OTHERWISE SPECIFIED: X ±0.20 X.X ±0.10 X.XX ±0.05 ANGULAR: ±0.5°	UNITS:	PROJECTION 
	DO NOT SCALE DRAWING	DRAWN BY: <b>Tony.Huang</b> APPROVED BY: SHEET: RELEASE LEVEL: DATE: Nov-22-21 REVISION:	

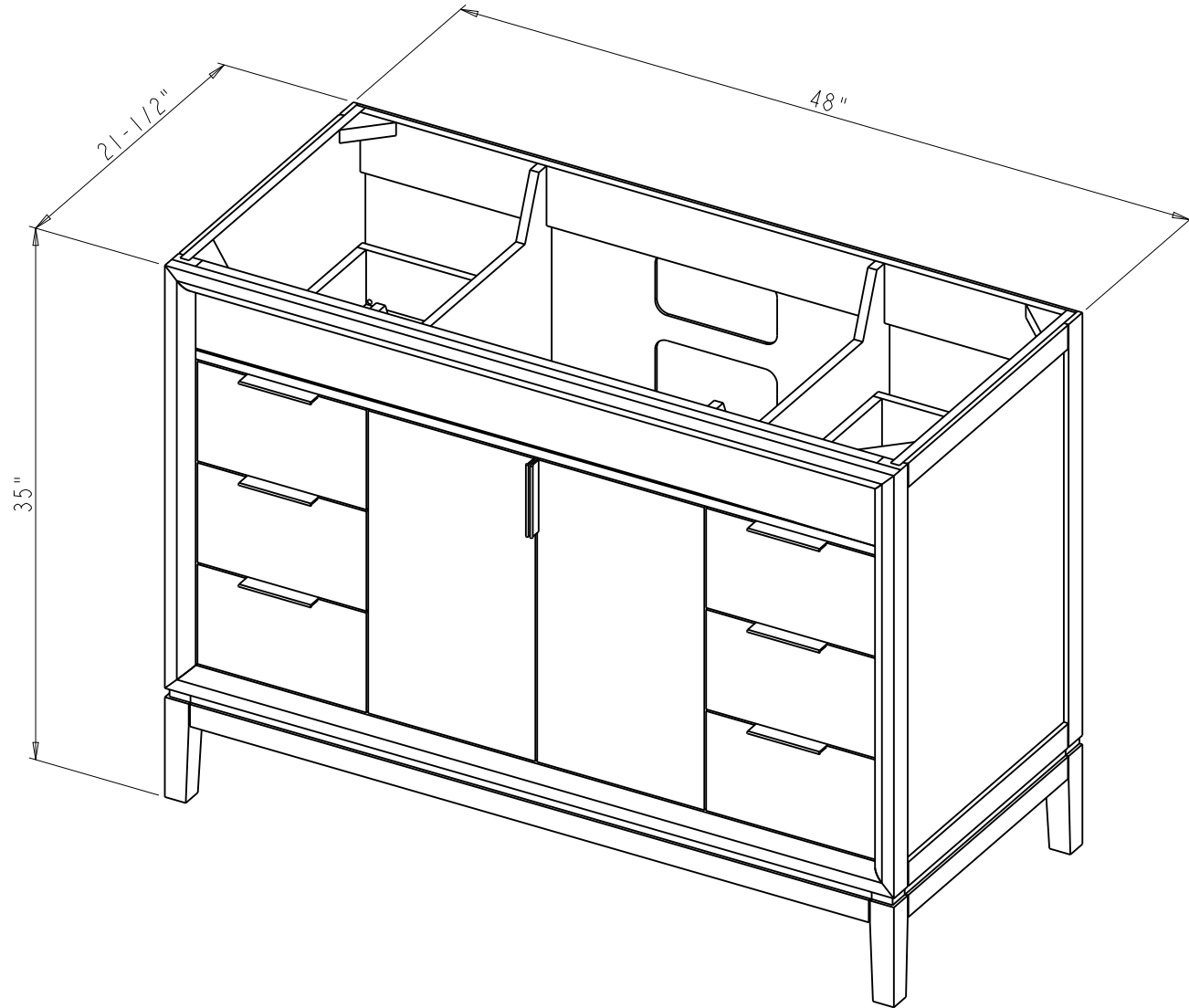

 <b>PROPRIETARY AND CONFIDENTIAL</b> THE INFORMATION CONTAINED IN THIS DRAWING IS THE SOLE PROPERTY OF HARDWARE RESOURCES INC. ANY REPRODUCTION IN PART OR AS A WHOLE WITHOUT THE WRITTEN PERMISSION OF HARDWARE RESOURCES INC. IS PROHIBITED.	ITEM#: VN2THE - 48		MATERIAL:		
	FINISH:		WEIGHT: 9		
	TOLERANCE UNLESS OTHERWISE SPECIFIED: X ±0.20 X.X ±0.10 X.XX ±0.05 ANGULAR: ±0.5°		UNITS:	DRAWN BY: <i>Tony.Huang</i>	DATE: May-20-21
	DO NOT SCALE DRAWING		SIZE:	APPROVED BY:	DATE:
		SHEET:	RELEASE LEVEL:	REVISION:	

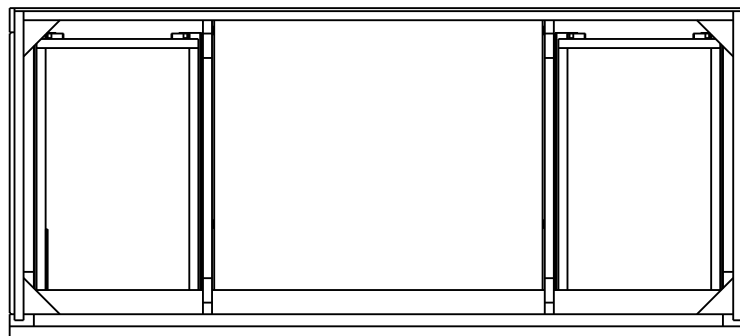
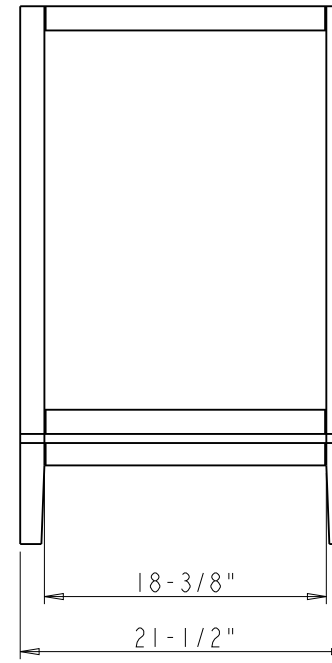
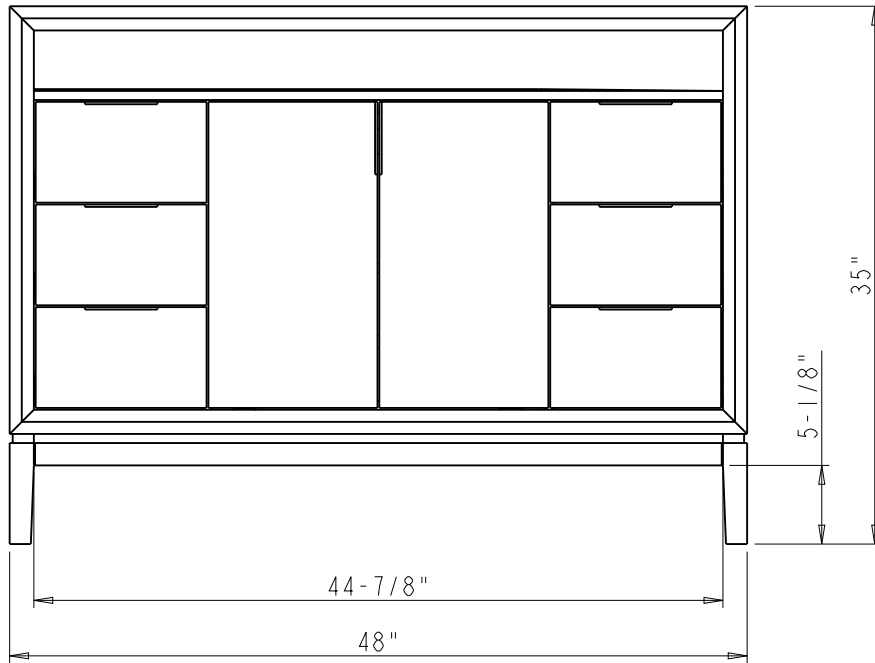

	ITEM#: VN2THE - 48		MATERIAL:		
	FINISH:		WEIGHT: 9		
<p><b>PROPRIETARY AND CONFIDENTIAL</b></p> <p>THE INFORMATION CONTAINED IN THIS DRAWING IS THE SOLE PROPERTY OF HARDWARE RESOURCES INC. ANY REPRODUCTION IN PART OR AS A WHOLE WITHOUT THE WRITTEN PERMISSION OF HARDWARE RESOURCES INC. IS PROHIBITED.</p> <p>DO NOT SCALE DRAWING</p>	PROJECTION		DATE: May-20-21		
	TOLERANCE UNLESS OTHERWISE SPECIFIED: X ±0.20 X.X ±0.10 X.XX ±0.05 ANGULAR: ±0.5°	UNITS:	DRAWN BY: <i>Tony.Huang</i>	DATE:	
	SIZE:	APPROVED BY:	DATE:		
	SHEET:	RELEASE LEVEL:	REVISION:		