

ADJUSTABLE-SHELF



Specification:

1. Material: MDF + Plywood + Birch
2. Finish: See Table
3. Hardware: See Table
4. Slides: USE58-300-18 + USCLIP2ND-4W(1 Set)
5. Hinge: 700.0537.25 + 600.1234.05 (4 Set)
6. Shelf Supports: I707BN (4 PCS)
7. The tolerance is +/- 1/8"

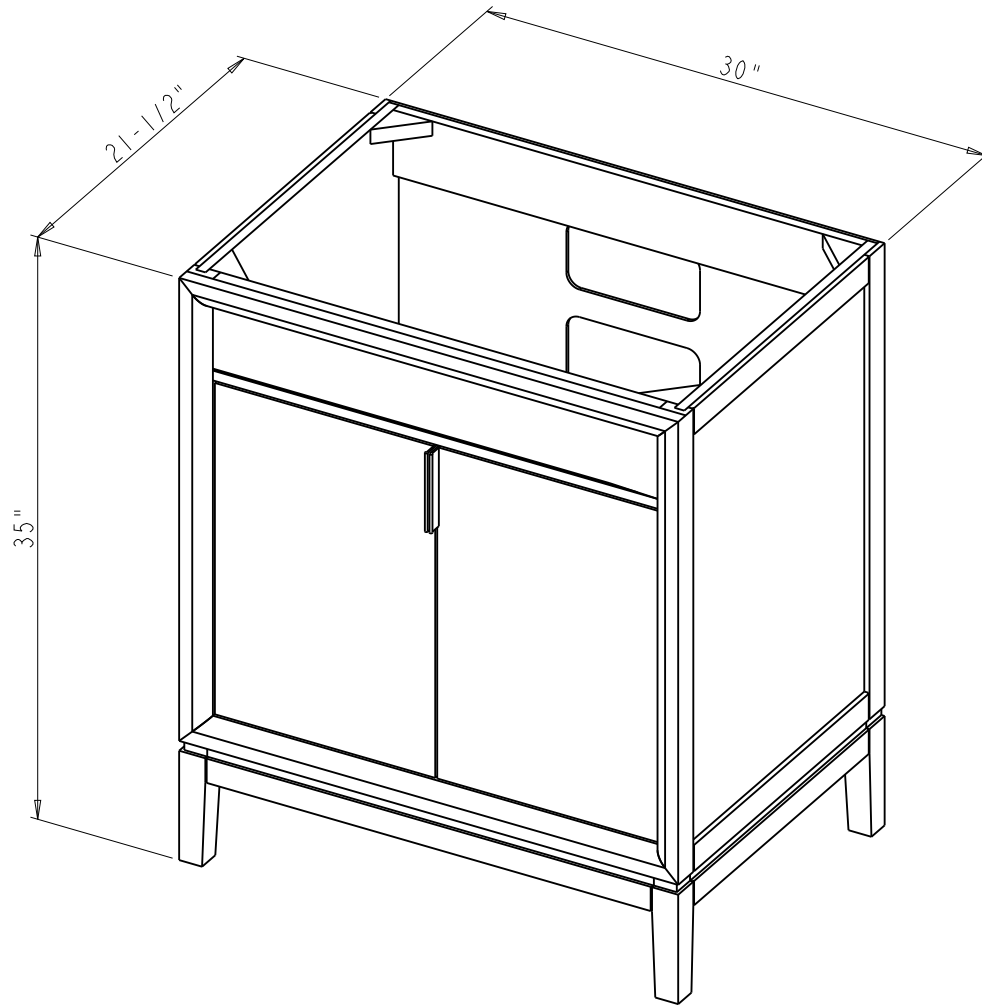

Item number	Finish	Deco Hardware	
		Item number	Qty
VN2THE-30-BK-NT	Black	PC, vendor's item	2
VN2THE-30-BL-NT	Blue	SBZ, vendor's item	2
VN2THE-30-BS-NT	Blue Steel	PC, vendor's item	2
VN2THE-30-GN-NT	Green	SBZ, vendor's item	2
VN2THE-30-GR-NT	Grey	PC, vendor's item	2
VN2THE-30-WH-NT	White	PC, vendor's item	2

<p>hardware resources</p> <p>PROPRIETARY AND CONFIDENTIAL</p> <p>THE INFORMATION CONTAINED IN THIS DRAWING IS THE SOLE PROPERTY OF HARDWARE RESOURCES INC. ANY REPRODUCTION IN PART OR AS A WHOLE WITHOUT THE WRITTEN PERMISSION OF HARDWARE RESOURCES INC. IS PROHIBITED.</p> <p>DO NOT SCALE DRAWING</p>	ITEM#: VN2THE-30	MATERIAL:	
	FINISH:	WEIGHT: 9	
	TOLERANCE UNLESS OTHERWISE SPECIFIED: X ±0.20 X.X ±0.10 X.XX ±0.05 ANGULAR: ±0.5°	UNITS: DRAWN BY: Tony.Huang	DATE: Nov-22-21
	SIZE: SHEET:	APPROVED BY: RELEASE LEVEL:	DATE: REVISION:

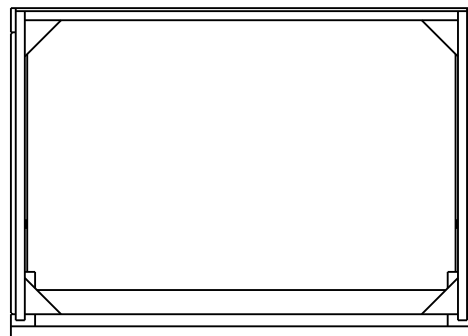
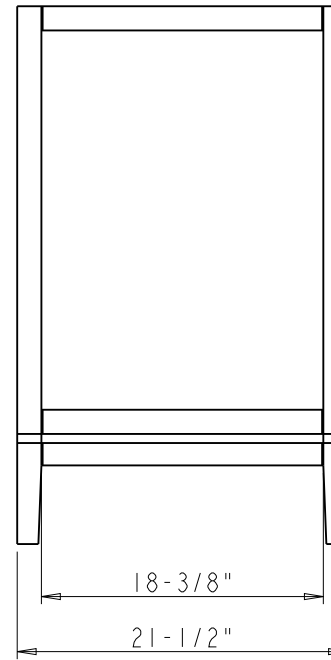
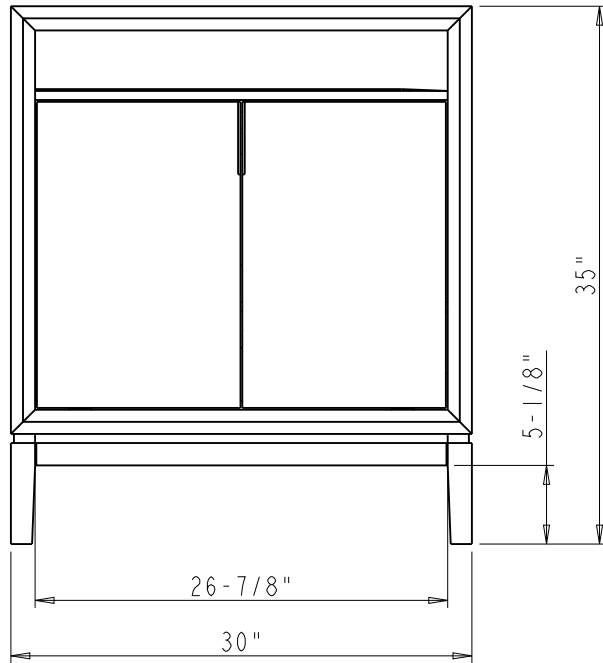

	ITEM#: VN2THE - 30		MATERIAL:		
	FINISH:		WEIGHT: 9		
<p>PROPRIETARY AND CONFIDENTIAL</p> <p>THE INFORMATION CONTAINED IN THIS DRAWING IS THE SOLE PROPERTY OF HARDWARE RESOURCES INC. ANY REPRODUCTION IN PART OR AS A WHOLE WITHOUT THE WRITTEN PERMISSION OF HARDWARE RESOURCES INC. IS PROHIBITED.</p>	PROJECTION 		DATE: May - 20 - 21		
	TOLERANCE UNLESS OTHERWISE SPECIFIED: X ±0.20 X.X ±0.10 X.XX ±0.05 ANGULAR: ±0.5°		UNITS:	DRAWN BY: Tony.Huang	DATE:
	DO NOT SCALE DRAWING		SIZE:	APPROVED BY:	DATE:
			SHEET:	RELEASE LEVEL:	REVISION:



 PROPRIETARY AND CONFIDENTIAL THE INFORMATION CONTAINED IN THIS DRAWING IS THE SOLE PROPERTY OF HARDWARE RESOURCES INC. ANY REPRODUCTION IN PART OR AS A WHOLE WITHOUT THE WRITTEN PERMISSION OF HARDWARE RESOURCES INC. IS PROHIBITED.	ITEM#: VN2THE - 30		MATERIAL:	
	FINISH:		WEIGHT:	
TOLERANCE UNLESS OTHERWISE SPECIFIED: X ±0.20 X.X ±0.10 X.XX ±0.05 ANGULAR: ±0.5° DO NOT SCALE DRAWING	UNITS:		DRAWN BY: <i>Tony.Huang</i>	
	SIZE:		APPROVED BY:	
	SHEET:		RELEASE LEVEL:	
	DATE:		REVISION:	
		PROJECTION 		DATE: May - 20 - 21
				9