





Specification:

1. Material: MDF + Plywood + Birch
2. Finish: See Table
3. Hardware: See Table
4. Slides: USE58-300-18 + USCLIP2ND-4W (2 Set)
5. Hinge: 700.0536.25 + 600.1234.05 (2 Set)
6. The tolerance is +/- 1/8"

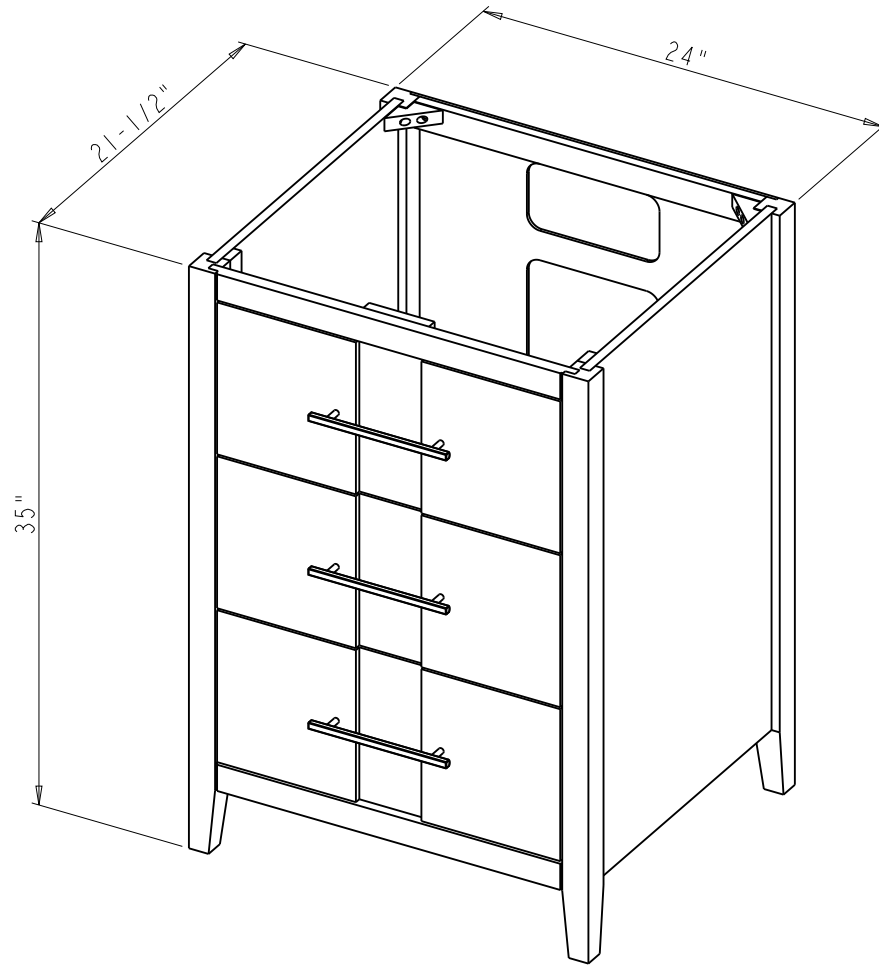

Item number	Finish	Deco Hardware	
		Item number	Qty
VN2KAT-24-BK-NT	Black	845-160PC	3
VN2KAT-24-BL-NT	Blue	845-160SBZ	3
VN2KAT-24-GR-NT	Grey	845-160MB	3
VN2KAT-24-WH-NT	White	845-160MB	3

 <p>PROPRIETARY AND CONFIDENTIAL</p> <p>THE INFORMATION CONTAINED IN THIS DRAWING IS THE SOLE PROPERTY OF HARDWARE RESOURCES INC. ANY REPRODUCTION IN PART OR AS A WHOLE WITHOUT THE WRITTEN PERMISSION OF HARDWARE RESOURCES INC. IS PROHIBITED.</p> <p>DO NOT SCALE DRAWING</p>	ITEM#: VN2KAT-24	MATERIAL:	
	FINISH:	WEIGHT: 9	
	TOLERANCE UNLESS OTHERWISE SPECIFIED: X ±0.20 X.X ±0.10 X.XX ±0.05 ANGULAR: ±0.5°	UNITS:	PROJECTION 
	DATE: Nov-22-21	DRAWN BY: Tony.Huang	DATE:
	APPROVED BY:	DATE:	
	RELEASE LEVEL:	REVISION:	

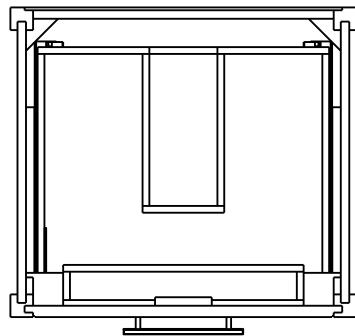
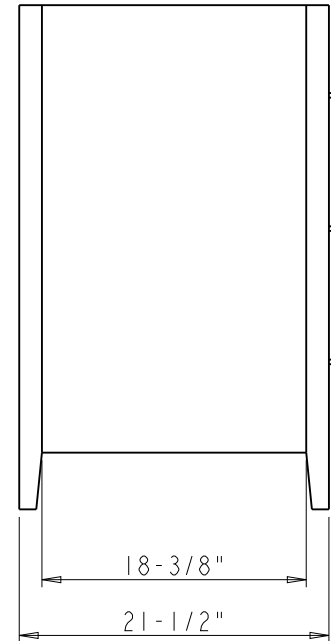
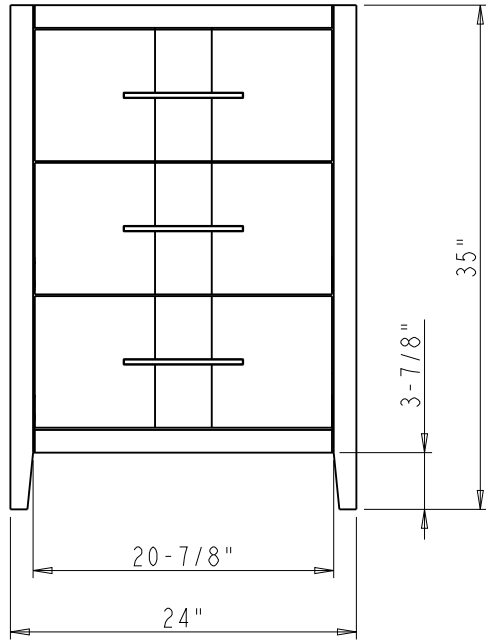

	ITEM#: VN2KAT - 24		MATERIAL:		
	FINISH:		WEIGHT: 9		
<p>PROPRIETARY AND CONFIDENTIAL</p> <p>THE INFORMATION CONTAINED IN THIS DRAWING IS THE SOLE PROPERTY OF HARDWARE RESOURCES INC. ANY REPRODUCTION IN PART OR AS A WHOLE WITHOUT THE WRITTEN PERMISSION OF HARDWARE RESOURCES INC. IS PROHIBITED.</p>	PROJECTION 		DATE: Jul-16-21		
	TOLERANCE UNLESS OTHERWISE SPECIFIED: X ±0.20 X.X ±0.10 X.XX ±0.05 ANGULAR: ±0.5°		UNITS:	DRAWN BY: <i>Hugo.cai</i>	DATE:
	DO NOT SCALE DRAWING		SIZE:	APPROVED BY:	DATE:
			SHEET:	RELEASE LEVEL:	REVISION:



 <p>PROPRIETARY AND CONFIDENTIAL</p> <p>THE INFORMATION CONTAINED IN THIS DRAWING IS THE SOLE PROPERTY OF HARDWARE RESOURCES INC. ANY REPRODUCTION IN PART OR AS A WHOLE WITHOUT THE WRITTEN PERMISSION OF HARDWARE RESOURCES INC. IS PROHIBITED.</p> <p>DO NOT SCALE DRAWING</p>	ITEM#: VN2KAT - 24		MATERIAL:		
	FINISH:		WEIGHT:		
	TOLERANCE UNLESS OTHERWISE SPECIFIED: X ±0.20 X.X ±0.10 X.XX ±0.05 ANGULAR: ±0.5°		UNITS:	DRAWN BY: <i>Hugo.cai</i>	DATE: Jul-16-21
	SIZE:		APPROVED BY:	DATE:	PROJECTION 
SHEET:		RELEASE LEVEL:	REVISION:		