

72" EMMELINE DOUBLE VANITY

D100-V72-M-PBO

FREEPOWER COMPATIBLE

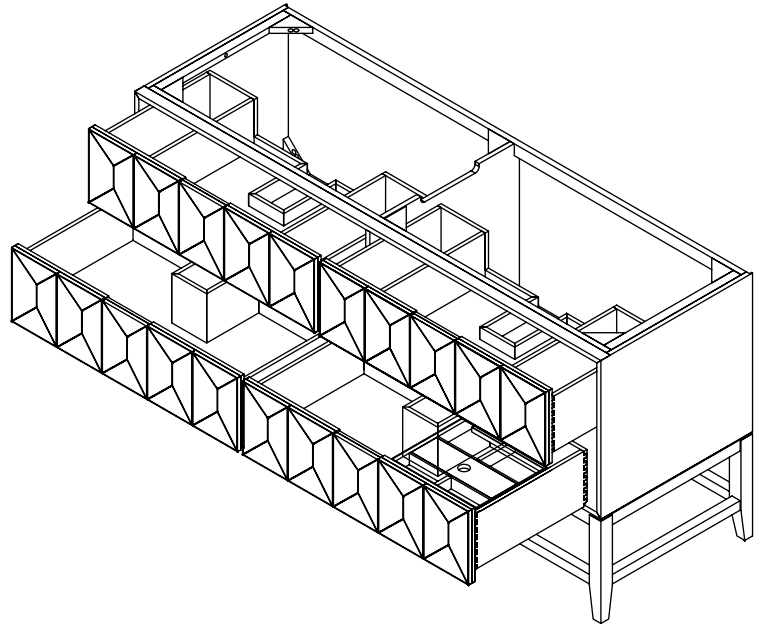
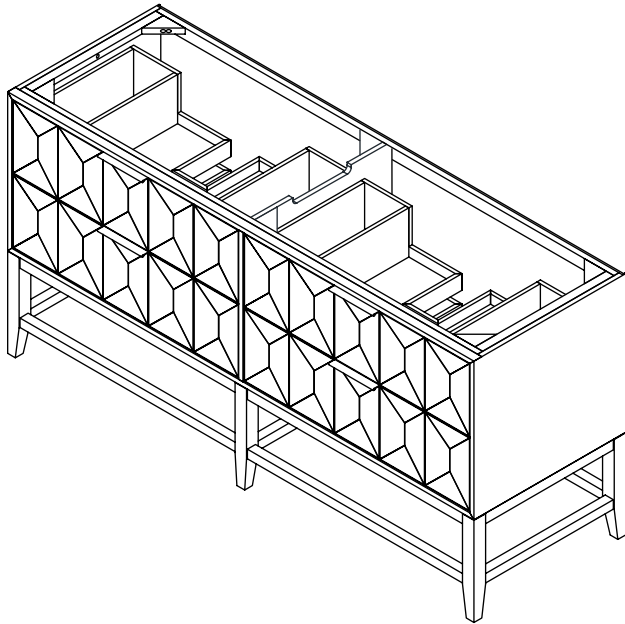

Features and Materials

- Solids: Ash
- Veneers: Ash
- Panels: Marine MDF
- Installation Type: Free-standing
- Number of Doors: 0
- Number of Drawers: 4
- Top Drawers: Left and Right Storage Compartments and center U-shaped tray style storage underneath the sink areas
- Bottom Drawers: U-Shaped drawers to accommodate plumbing
- Assembly Required: No
- Removable organizer with aluminum laminate liner
- Drawer Boxes: Ash veneer over Marine MDF
- English Dovetail joinery
- Aluminum Laminate Drawer Liners
- Hardware Finish: Champagne Brass
- Full Extension, Soft Close Glides
- Vanity Top: Not Included – Optional 3cm Tops available
- Number of Basins: 2
(included with optional countertop purchase)
- Adjustable Levelers

Dimension

- Width: 71-1/2" (1817mm)
- Depth: 23 -1/4" (591mm)
- Height: 34 - 3/4" (884 mm)
- Rough-In: 21" (551mm)

Drawer Edge Pulls

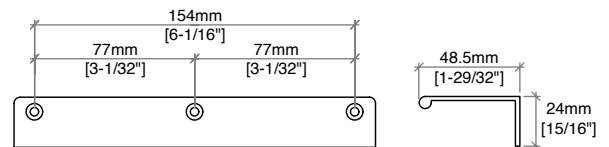

72" EMMELINE DOUBLE VANITY
D100-V72-M-PBO

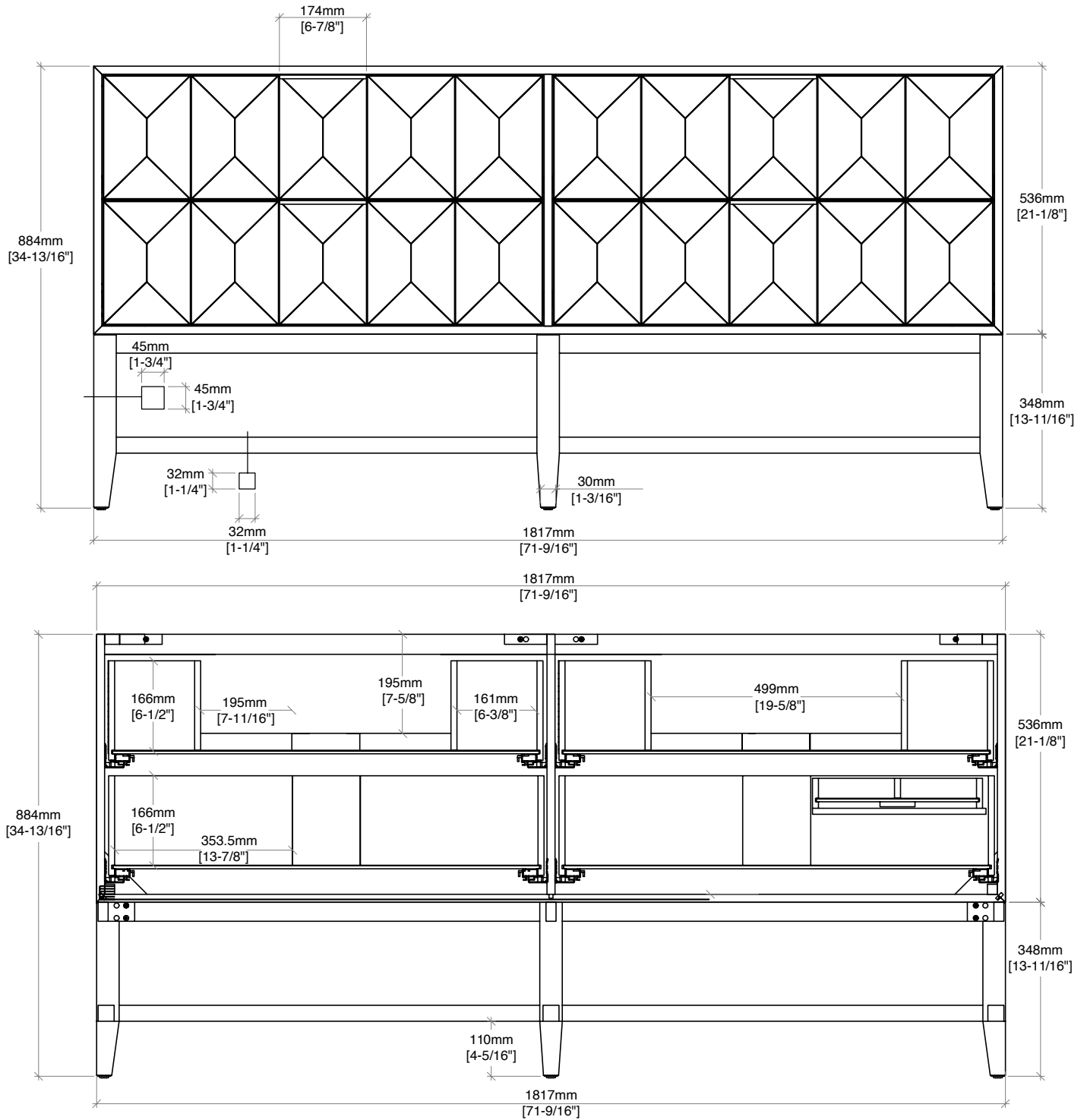

All dimensions are nominal

Diagrams are of cabinet only—James Martin Optional Countertops and sinks are not shown

Visit website for warranty and installation information
www.jamesmartinvanities.com

72" EMMELINE DOUBLE VANITY

D100-V72-M-PBO

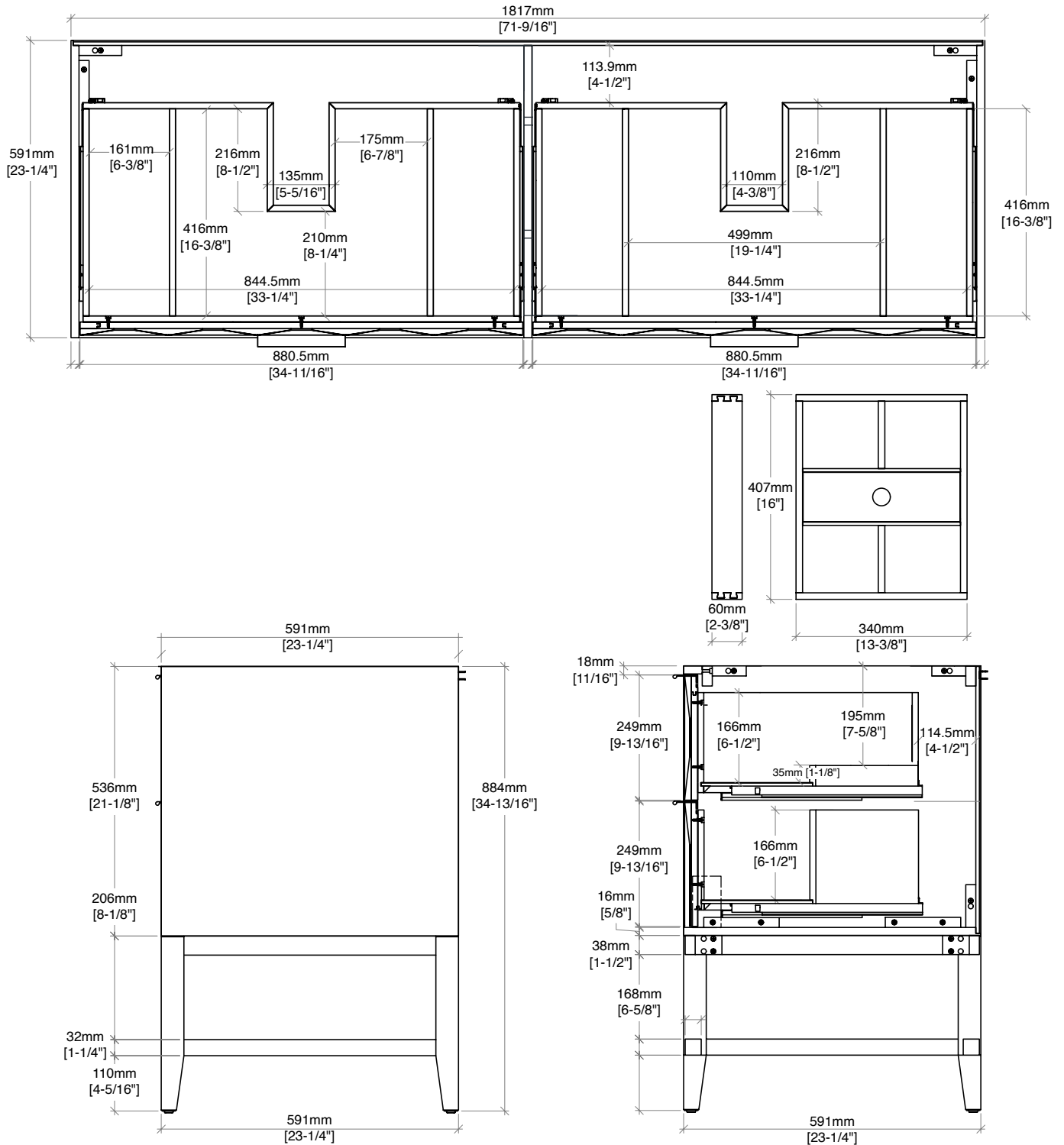

All dimensions are nominal

Diagrams are of cabinet only—James Martin Optional Countertops and sinks are not shown

Visit website for warranty and installation information
www.jamesmartinvanities.com

72" EMMELINE DOUBLE VANITY
D100-V72-M-PBO

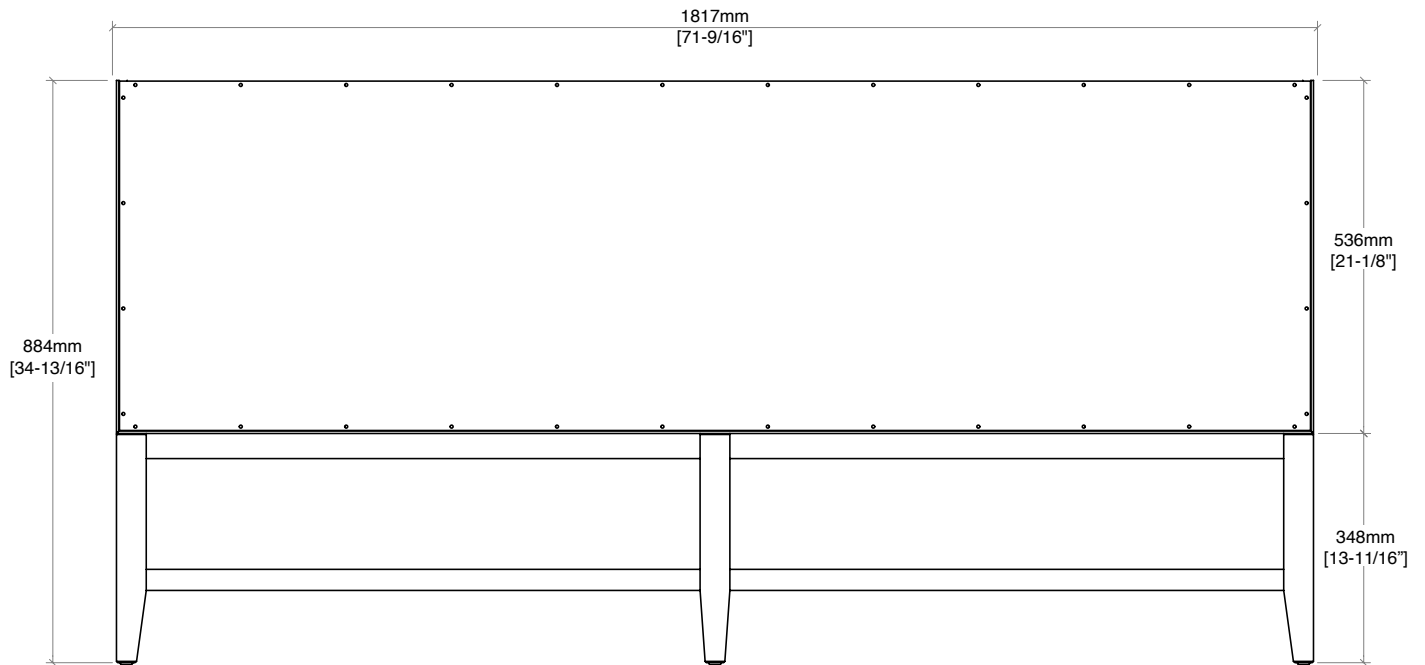

All dimensions are nominal
Diagrams are of cabinet only—James Martin Optional Countertops and sinks are not shown

Visit website for warranty and installation information
www.jamesmartinvanities.com

Ēclos Care and Maintenance

ĒCLOS materials have been designed to offer exceptional performance and aesthetics, making them the ideal choice for bathroom countertops. However, as with any high-end material, they are not completely unalterable. To ensure its useful life and preserve its beauty, it is important to follow some basic recommendations for use and maintenance.

Daily Maintenance: To maintain the appearance and performance of the material, it is recommended to clean stains and residue as soon as possible with a soft cloth, neutral soap and water. Avoid water puddling on the surface.

Cleaning: Avoid using cleaning products, aggressive solvents, strong acids, abrasive scouring pads, as they can damage the finish and properties of the material.

Applying hot tap water, along with a soft cloth and a neutral detergent, helps dissolve greasy and stuck-on residue, making it easier to remove without damaging the surface.

For stubborn stains, follow these guidelines:

Water and Lime Stains

Neutral anti-scale products applied with wet sponge

Other Stains

Oxygenated cleaners with a maximum hydrogen peroxide concentration of 5.5% applied with a wet sponge.

Impact Resistance Defined

Although Ēclos is durable, careful use will extend its lifespan. Handle heavy and sharp objects with care near the surface, avoiding sudden impact.

Heat Precautions

Although Ēclos is designed to withstand high temperatures for short periods of time, it is not recommended that the product be exposed to sustained contact with a heat source, like curling irons. The use of a trivet is recommended in such situations.

UV Exposure

Avoid direct sunlight, as it can visually alter the material over time. To fully enjoy the original design and color of Ēclos, we recommend using LED or fluorescent lighting.

SNK-RF RECTANGULAR PORCELAIN UNDERMOUNT SINK

JAMES MARTIN
VANITIES

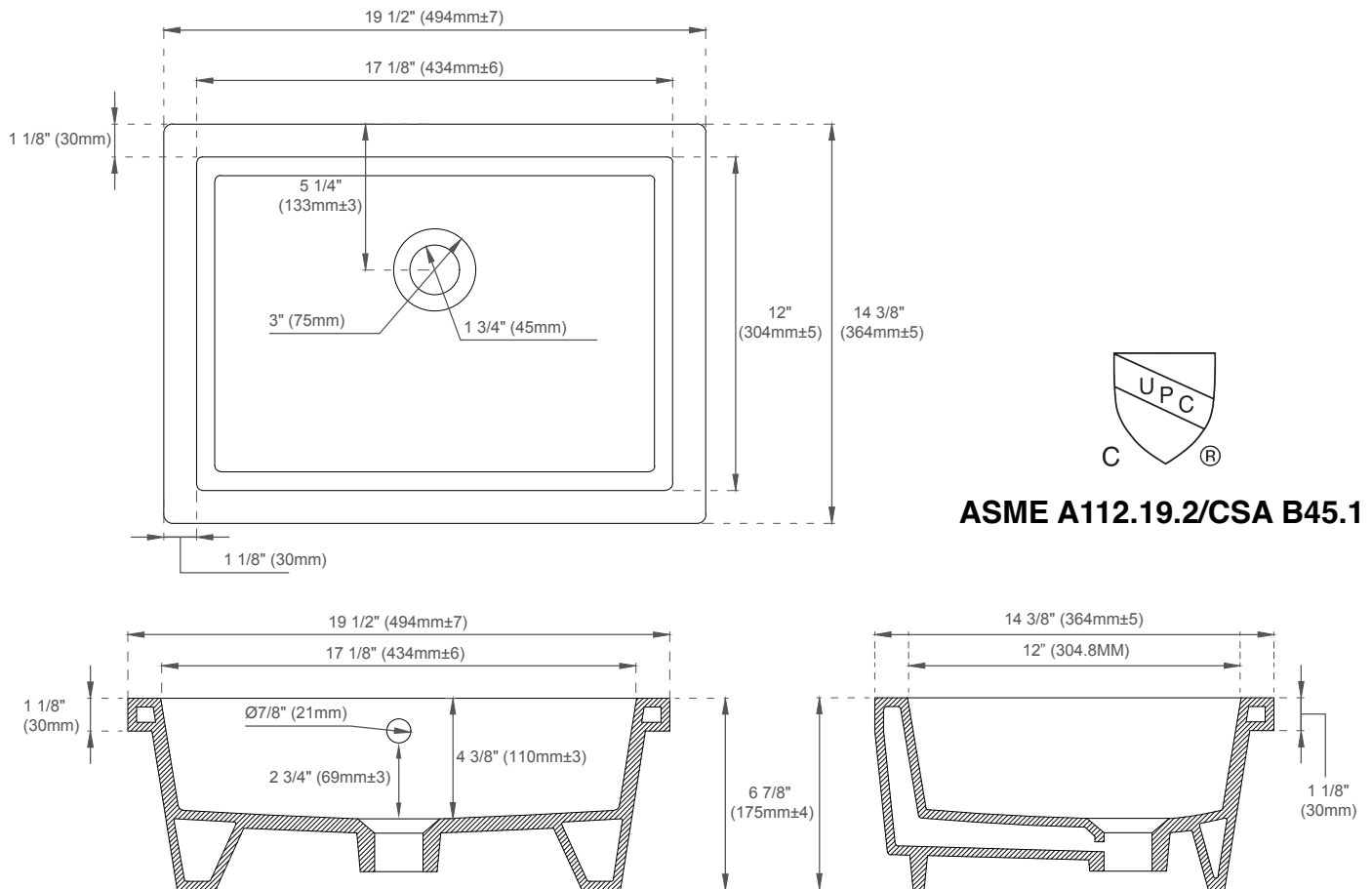

FEATURES:

- Designed to fit with all James Martin Vanities with a 3cm Silestone quartz top
- Sink Material: Porcelain
- Integrated overflow
- Sink shape: Rectangular with straight sides
- Sink ships in a separate carton from top and vanity
- Sink clips and hardware are not included. All mounting hardware ships with the 3cm quartz tops
- Drain included: NO
- Faucet included: NO
- Overflow cover: NO

EXTERNAL DIMENSIONS:

Length: 19-1/2"
Width: 14-3/8"
Height: 6-7/8"

INTERNAL BASIN DIMENSIONS:

Basin Length: 17-1/8"
Basin Width: 12"
Basin Depth: 4-3/8"
Fits Drain Hole Size: 1-1/2"

All dimensions are nominal

Visit website for warranty and installation information
www.jamesmartinvanities.com

Version: 202301