

35 7/8"

Item Number:
E444-V36-MCA

JAMES MARTIN



VANITIES™

Addison 35 7/8" Single Cabinet
Diagrams with Dimensions
page 01 of 03

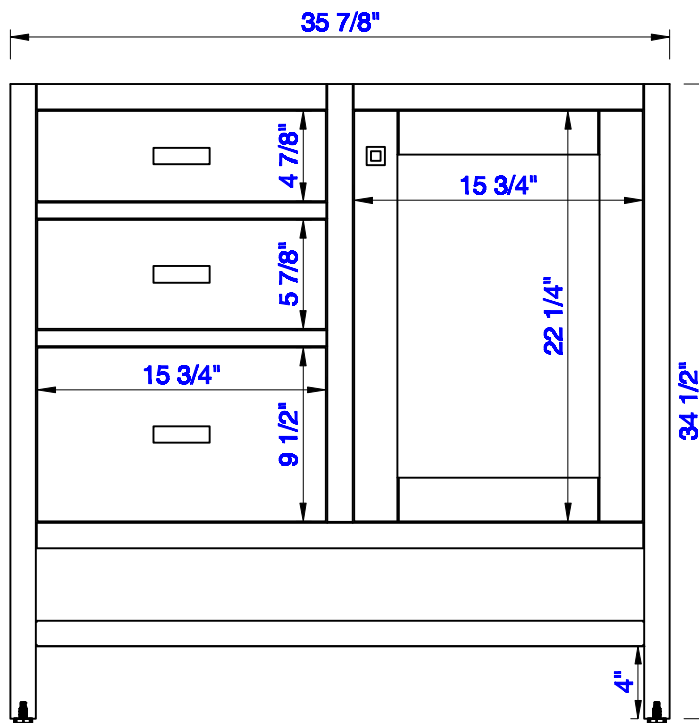

NOTE ONE: Countertops are not shown in these diagrams. (Cabinet Only)

NOTE TWO: This vanity does not have a Backsplash.

Please consult our website for Countertop Diagrams: www.jamesmartinvanities.com

Version:202004

35 7/8"

Item Number:
E444-V36-MCA

JAMES MARTIN



VANITIES™

Addison 35 7/8" Single Cabinet
Diagrams with Dimensions
page 02 of 03

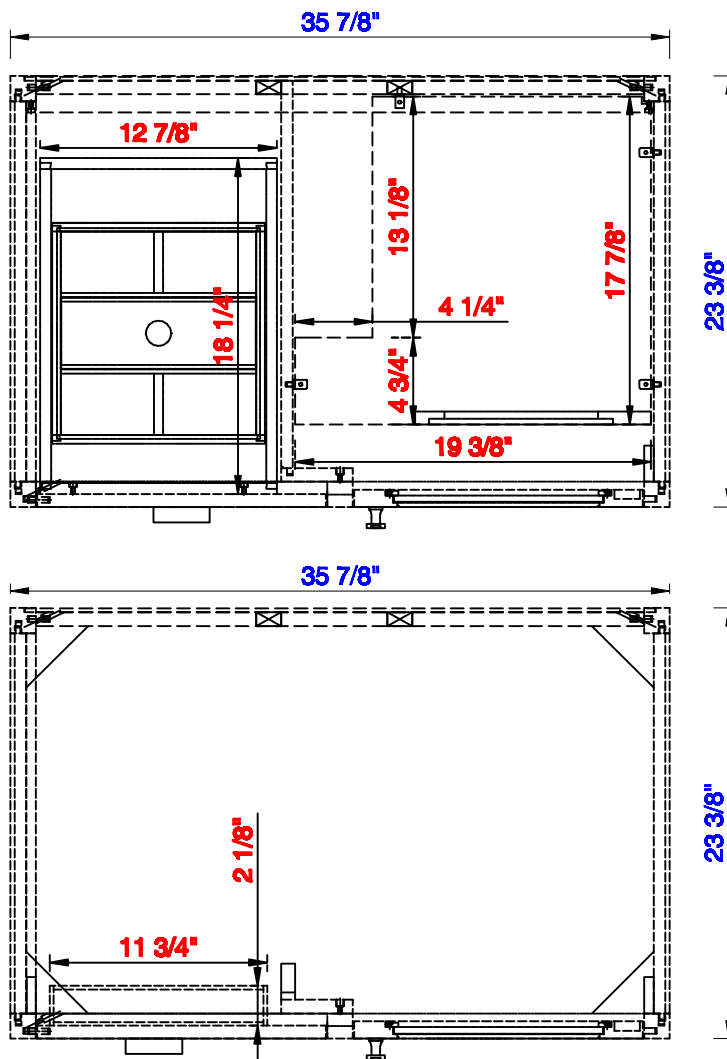

NOTE ONE: Countertops are not shown in these diagrams. (Cabinet Only)

NOTE TWO: Internal Shelves (Shown) are designed to align with sinks in James Martin's Optional Countertops. Customer's own countertops and sinks may align differently, and modification may be required. Please consult our website for Countertop Diagrams: www.jamesmartinvanities.com

Version:202004

35 7/8"

Item Number:
E444-V36-MCA

JAMES MARTIN

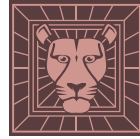

VANITIES™

Addison 35 7/8" Single Cabinet
Diagrams with Dimensions
page 03 of 03

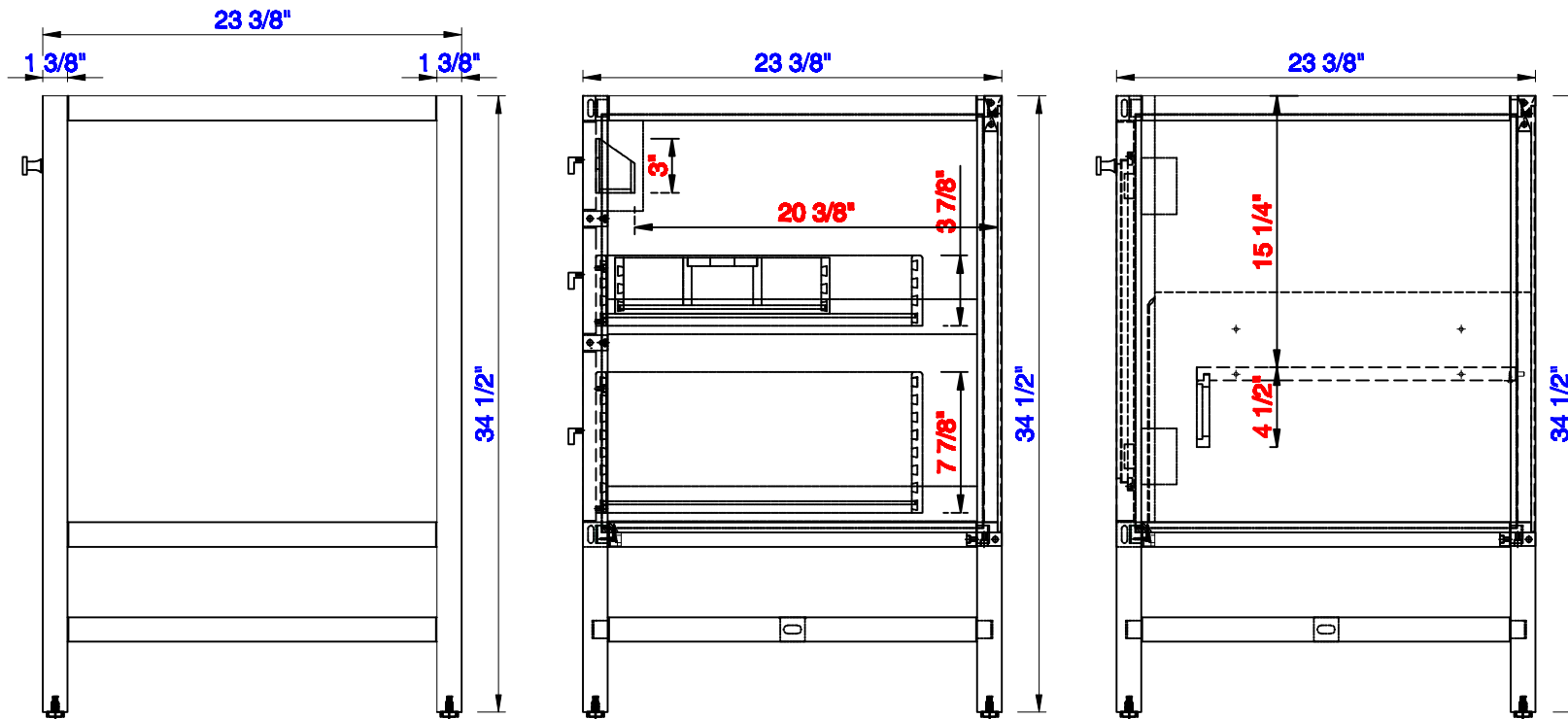

NOTE ONE: Countertops are not shown in these diagrams. (Cabinet Only)

NOTE TWO: This vanity does not have a Backsplash.

Please consult our website for Countertop Diagrams: www.jamesmartinvanities.com

Version:202004

910mm

Item Number:
E444-V36-MCA

JAMES MARTIN

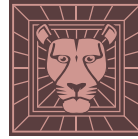

VANITIES™

Addison 910mm Single Cabinet
Diagrams with Dimensions
page 01 of 03

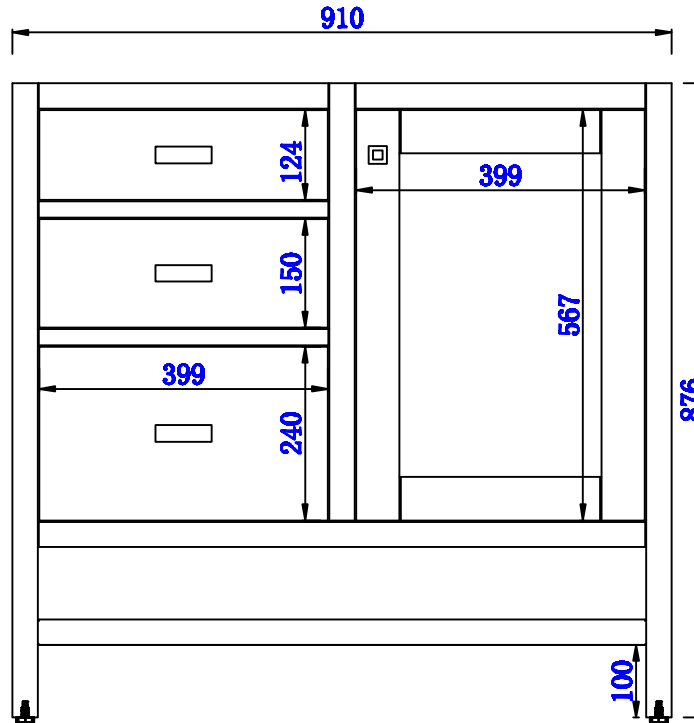

NOTE ONE: Countertops are not shown in these diagrams. (Cabinet Only)

NOTE TWO: This vanity does not have a Backsplash.

Please consult our website for Countertop Diagrams: www.jamesmartinvanities.com

Version:202004

910mm

Item Number:
E444-V36-MCA

JAMES MARTIN

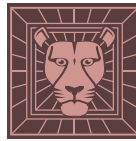

VANITIES™

Addison 910mm Single Cabinet
Diagrams with Dimensions
page 02 of 03

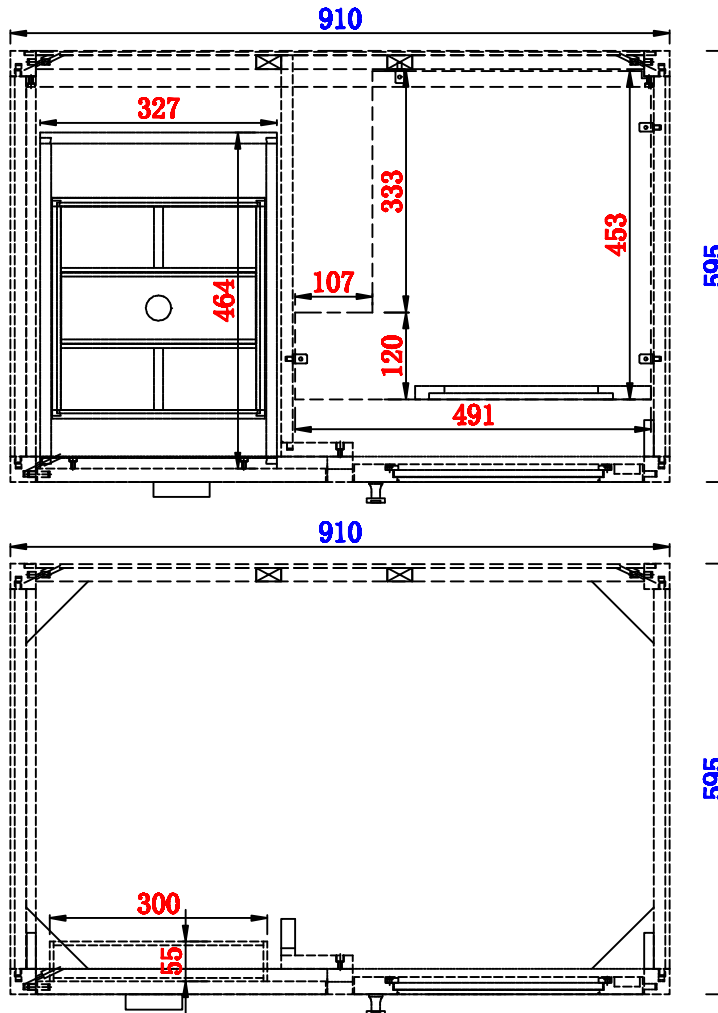

NOTE ONE: Countertops are not shown in these diagrams. (Cabinet Only)

NOTE TWO: Internal Shelves (Shown) are designed to align with sinks in James Martin's Optional Countertops. Customer's own countertops and sinks may align differently, and modification may be required. Please consult our website for Countertop Diagrams: www.jamesmartinvanities.com

Version:202004

910mm

Item Number:
E444-V36-MCA

JAMES MARTIN

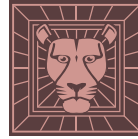

VANITIES™

Addison 910mm Single Cabinet
Diagrams with Dimensions
page 03 of 03

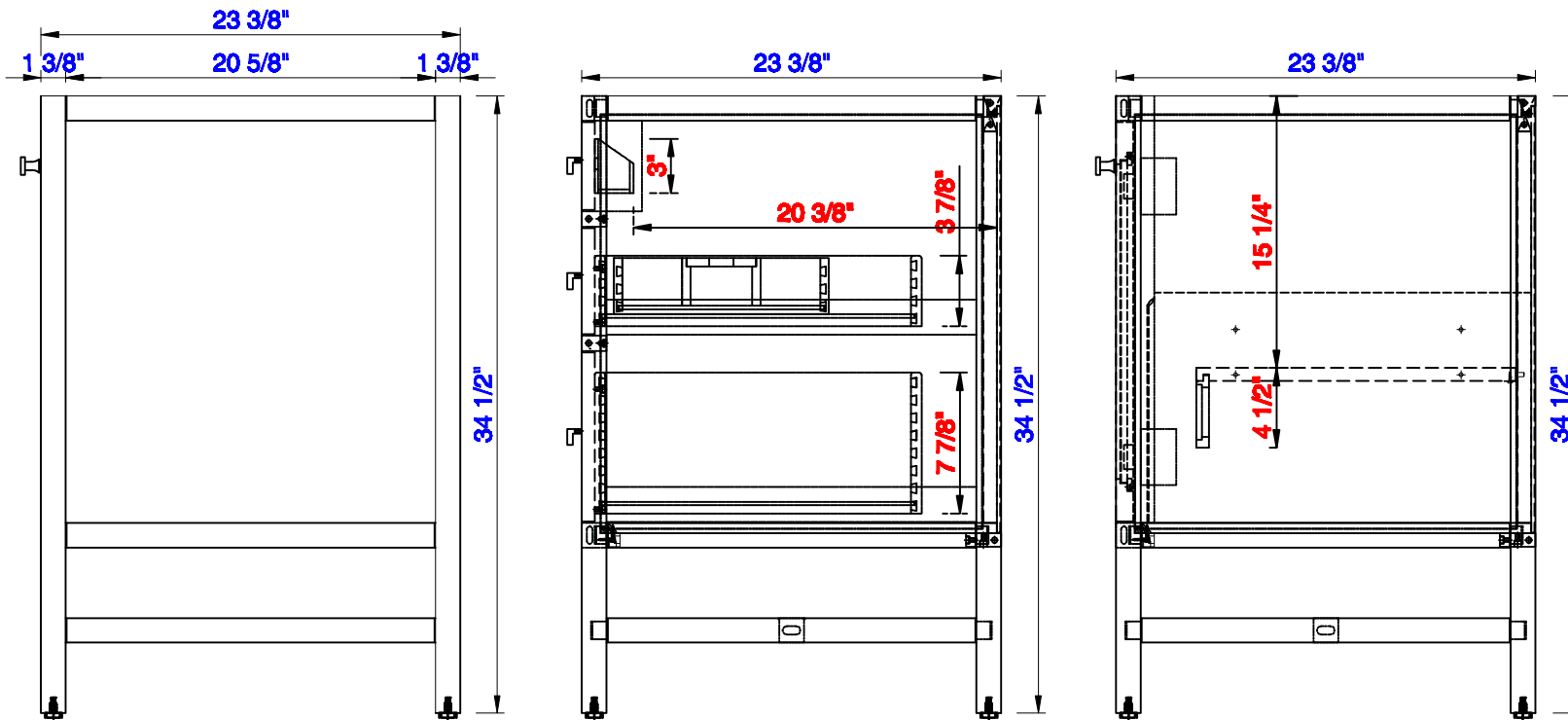

NOTE ONE: Countertops are not shown in these diagrams. (Cabinet Only)

NOTE TWO: This vanity does not have a Backsplash.

Please consult our website for Countertop Diagrams: www.jamesmartinvanities.com

Version:202004

35 7/8"

Item Number:
E444-V36-MCA

JAMES MARTIN

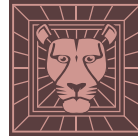

VANITIES™

Addison 35 7/8" Single Cabinet
Diagrams with Dimensions
page 01 of 01

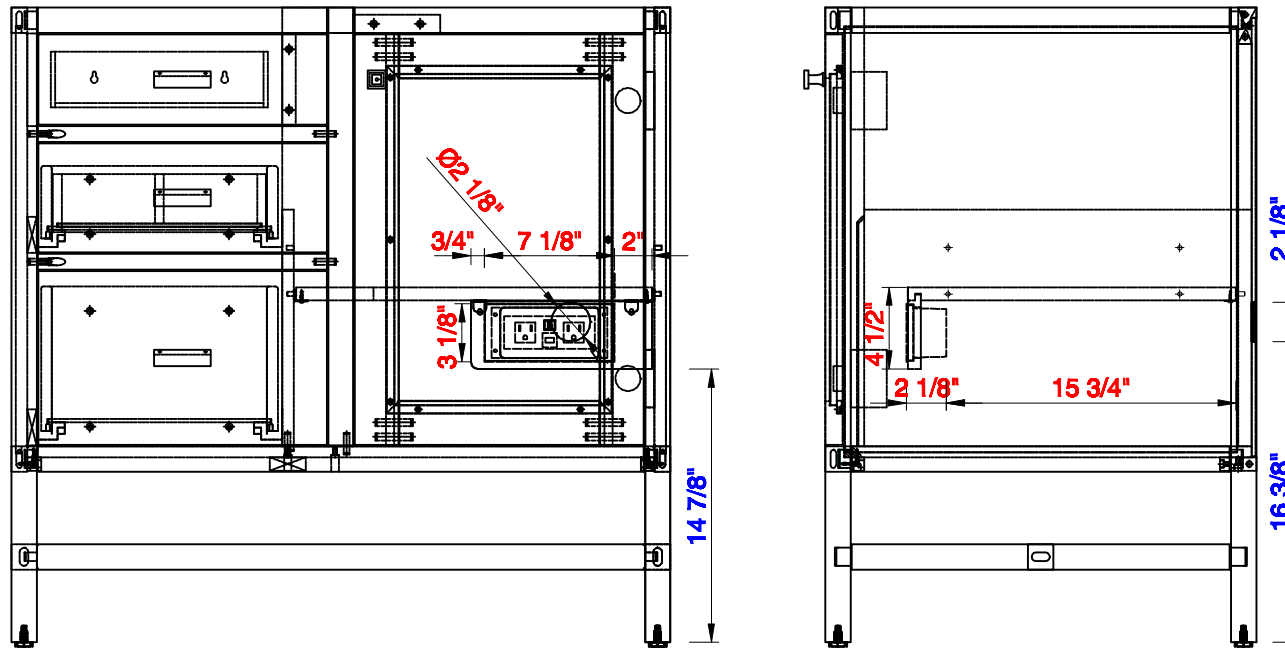

910mm

Item Number:
E444-V36-MCA

JAMES MARTIN



VANITIES™

Addison 910mm Single Cabinet
Diagrams with Dimensions
page 01 of 01

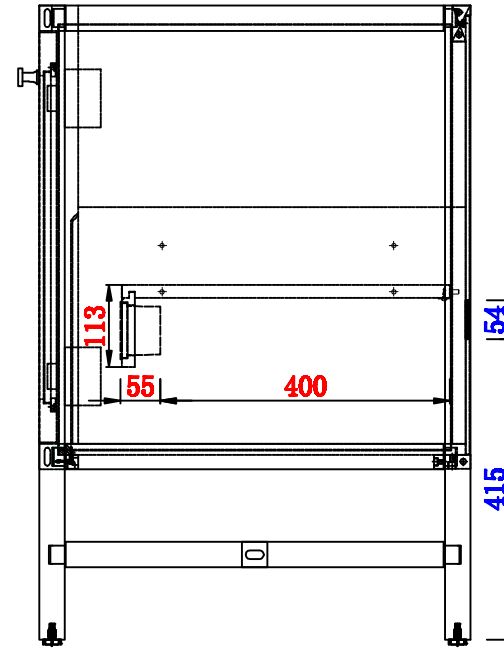
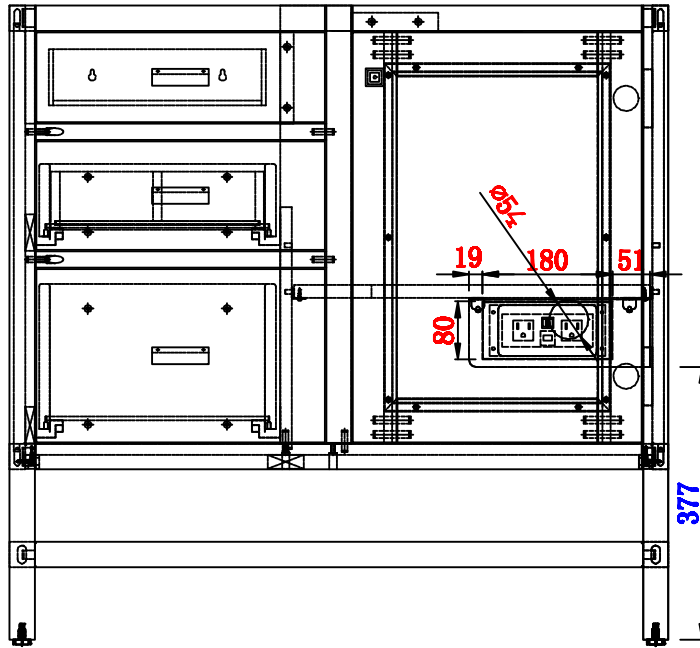

15"

Item Number:
E444-BC15-MCA
E444-BC15-GW

JAMES MARTIN

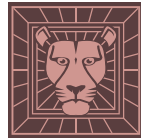

VANITIES™

Addison 15" Base Cabinet with Drawers
Diagrams with Dimensions
page 01 of 03

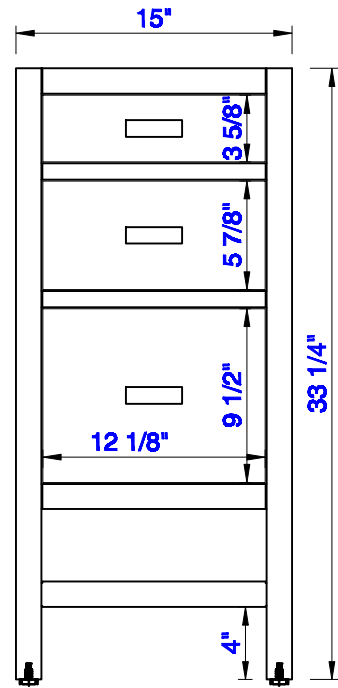

NOTE ONE: Countertops are not shown in these diagrams. (Cabinet Only)

NOTE TWO: This Cabinet does not have a Backsplash.

Please consult our website for Countertop Diagrams: www.jamesmartinvanities.com

Version:202009

15"

Item Number:
E444-BC15-MCA
E444-BC15-GW

JAMES MARTIN



VANITIES™

Addison 15" Base Cabinet with Drawers
Diagrams with Dimensions
page 02 of 03

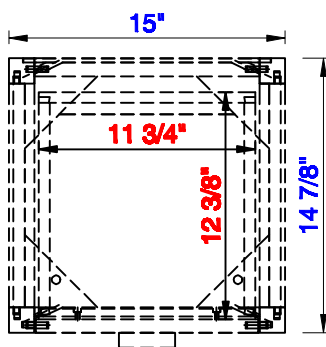
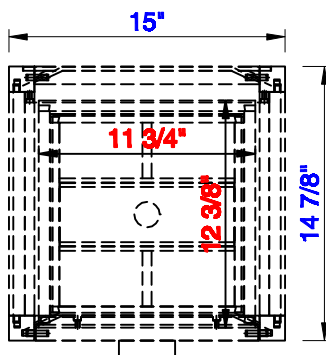

NOTE ONE: Countertops are not shown in these diagrams. (Cabinet Only)
Please consult our website for Countertop Diagrams: www.jamesmartinvanities.com

Version:202009

15"

Item Number:
E444-BC15-MCA
E444-BC15-GW

JAMES MARTIN

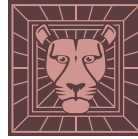

VANITIES™

Addison 15" Base Cabinet with Drawers
Diagrams with Dimensions
page 03 of 03

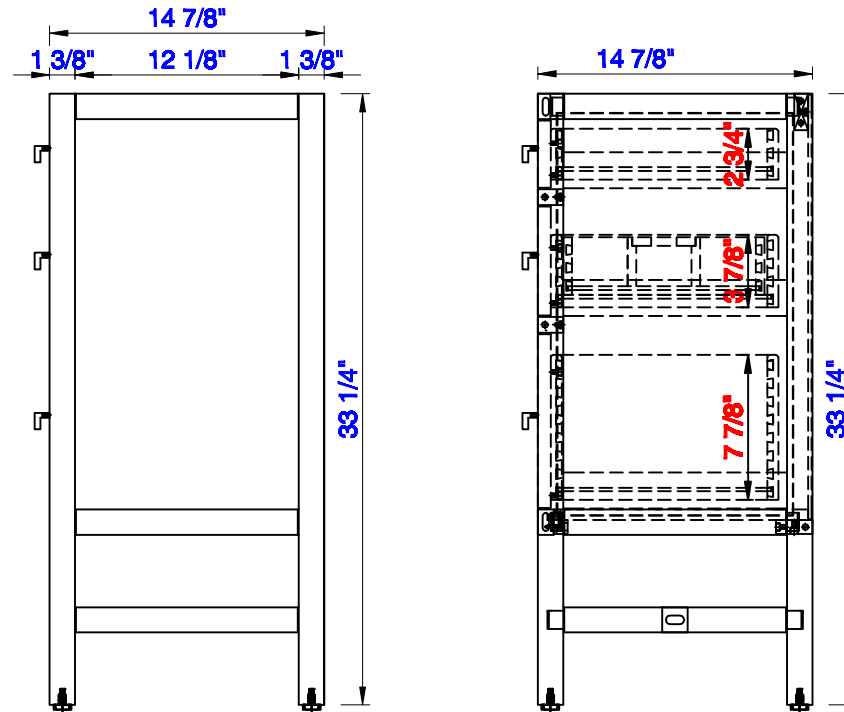

NOTE ONE: Countertops are not shown in these diagrams. (Cabinet Only)

NOTE TWO: This Cabinet does not have a Backsplash.

Please consult our website for Countertop Diagrams: www.jamesmartinvanities.com

Version:202009

381mm

Item Number:
E444-BC15-MCA
E444-BC15-GW

JAMES MARTIN

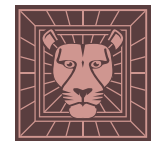

VANITIES™

Addison 381mm Base Cabinet with Drawers
Diagrams with Dimensions
page 01 of 03

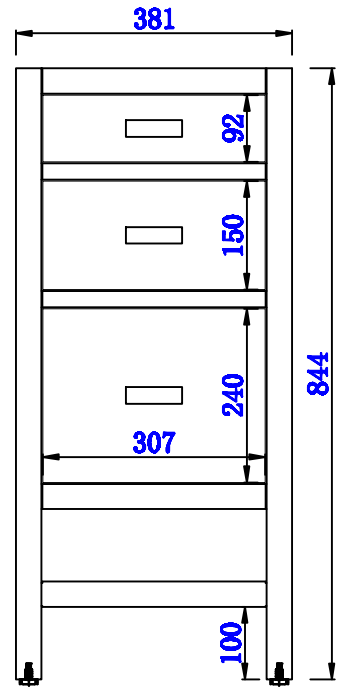

NOTE ONE: Countertops are not shown in these diagrams. (Cabinet Only)

NOTE TWO: This Cabinet does not have a Backsplash.

Please consult our website for Countertop Diagrams: www.jamesmartinvanities.com

Version:202009

381mm

Item Number:
E444-BC15-MCA
E444-BC15-GW

JAMES MARTIN



VANITIES™

Addison 381mm Base Cabinet with Drawers
Diagrams with Dimensions
page 02 of 03

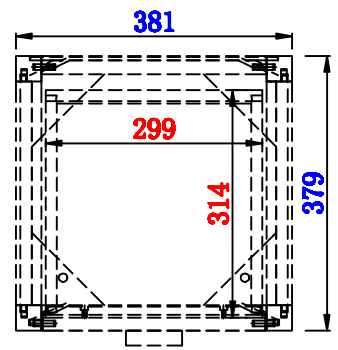
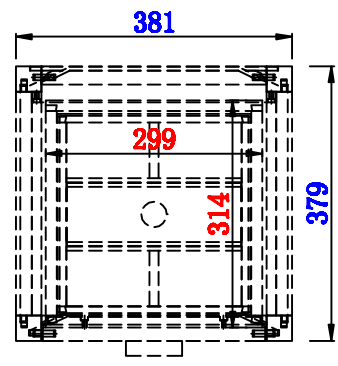

NOTE ONE: Countertops are not shown in these diagrams. (Cabinet Only)
Please consult our website for Countertop Diagrams: www.jamesmartinvanities.com

Version:202009

381mm

Item Number:
E444-BC15-MCA
E444-BC15-GW

JAMES MARTIN

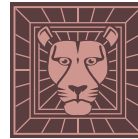

VANITIES™

Addison 381mm Base Cabinet with Drawers
Diagrams with Dimensions
page 03 of 03

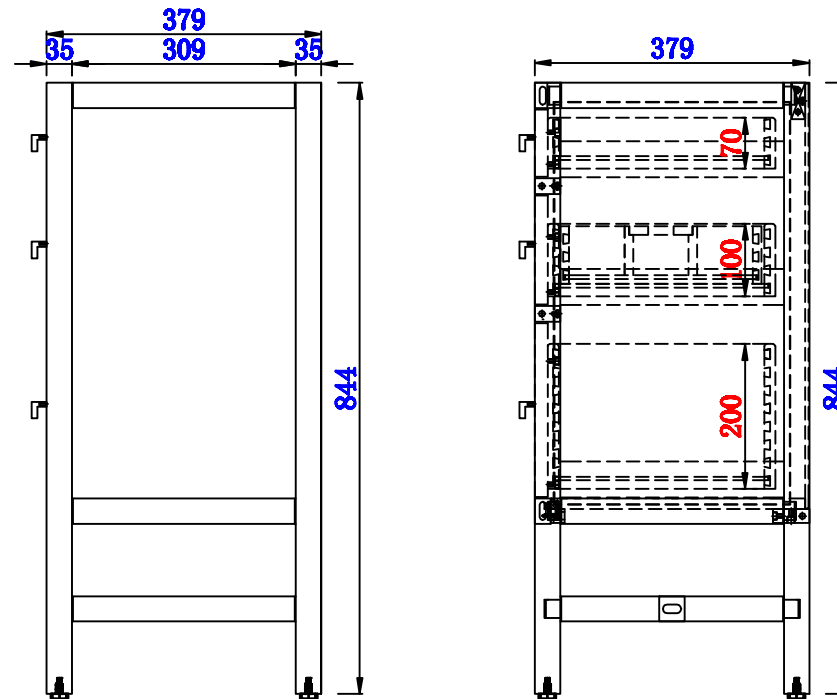

NOTE ONE: Countertops are not shown in these diagrams. (Cabinet Only)

NOTE TWO: This Cabinet does not have a Backsplash.

Please consult our website for Countertop Diagrams: www.jamesmartinvanities.com

Version:202009

12"

Item Number:
E444-H12R-MCA
E444-H12R-GW

JAMES MARTIN



VANITIES™

Addison 12" Petite Tower Hutch - Right
Diagrams with Dimensions
page 01 of 03

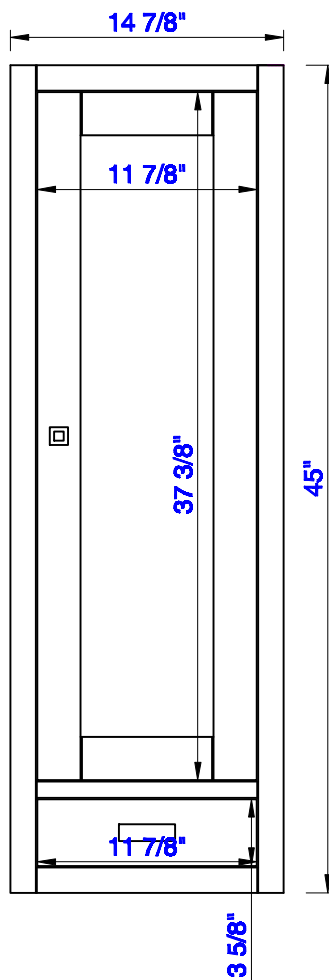

12"

Item Number:
E444-H12R-MCA
E444-H12R-GW

JAMES MARTIN

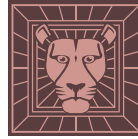

VANITIES™

Addison 12" Petite Tower Hutch - Right
Diagrams with Dimensions
page 02 of 03

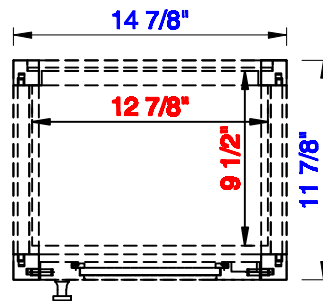
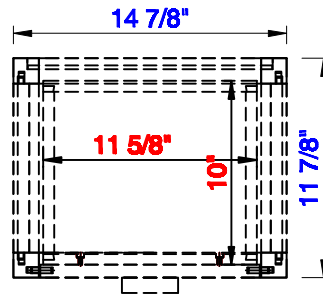

12"

Item Number:
E444-H12R-MCA
E444-H12R-GW

JAMES MARTIN

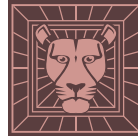

VANITIES™

Addison 12" Petite Tower Hutch - Right
Diagrams with Dimensions
page 03 of 03

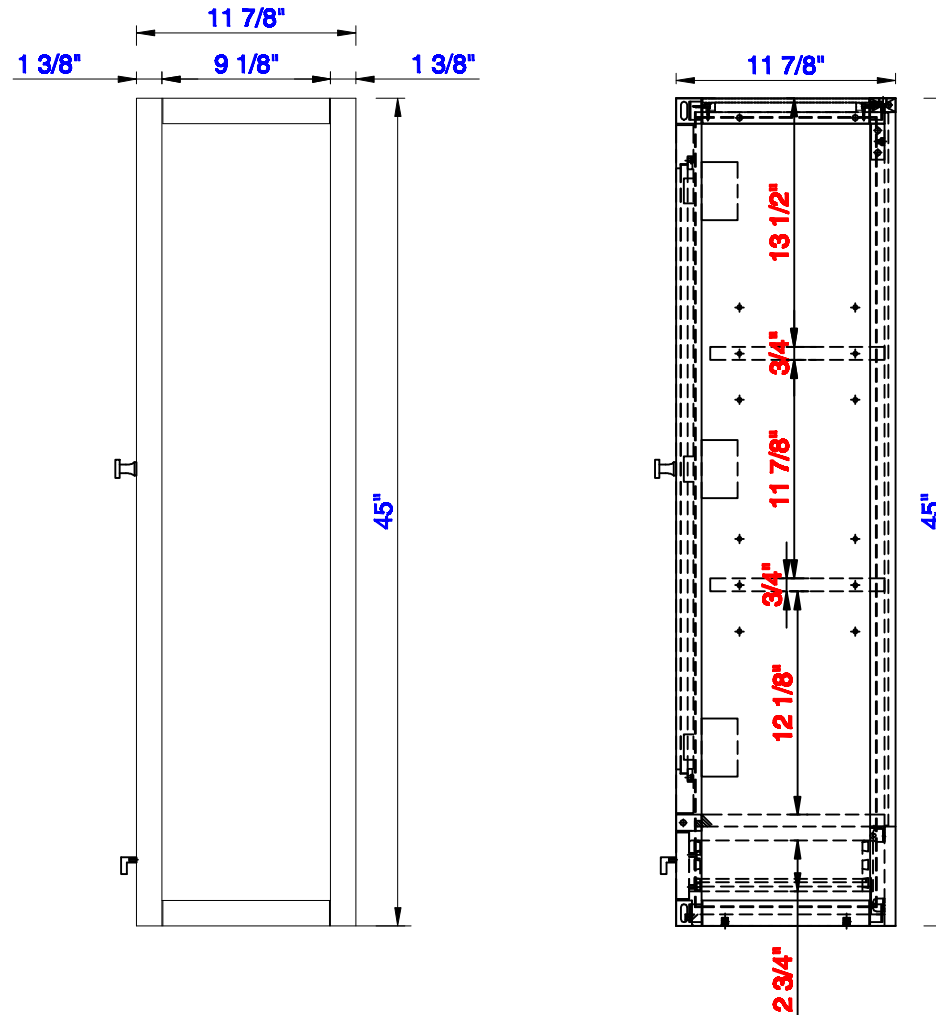

305mm

Item Number:
E444-H12R-MCA
E444-H12R-GW

JAMES MARTIN

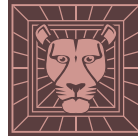

VANITIES™

Addison 305mm Petite Tower Hutch - Right
Diagrams with Dimensions
page 01 of 03

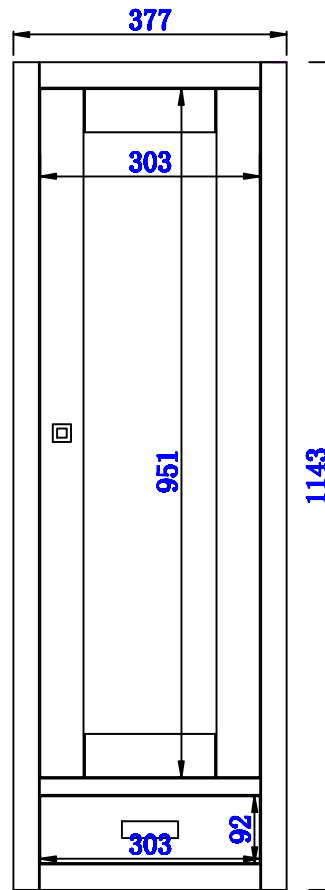

305mm

Item Number:
E444-H12R-MCA
E444-H12R-GW

JAMES MARTIN

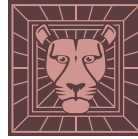

VANITIES™

Addison 305mm Petite Tower Hutch - Right
Diagrams with Dimensions
page 02 of 03

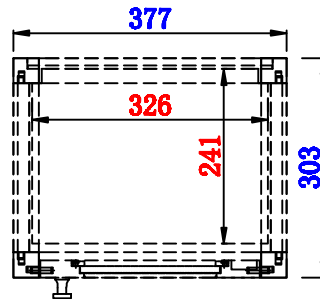
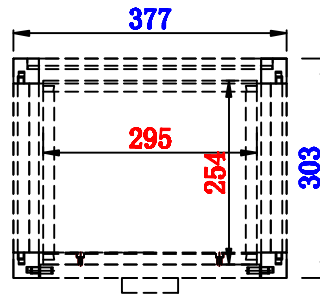

305mm

Item Number:
E444-H12R-MCA
E444-H12R-GW

JAMES MARTIN

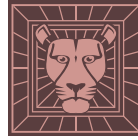

VANITIES™

Addison 305mm Petite Tower Hutch - Right
Diagrams with Dimensions
page 03 of 03

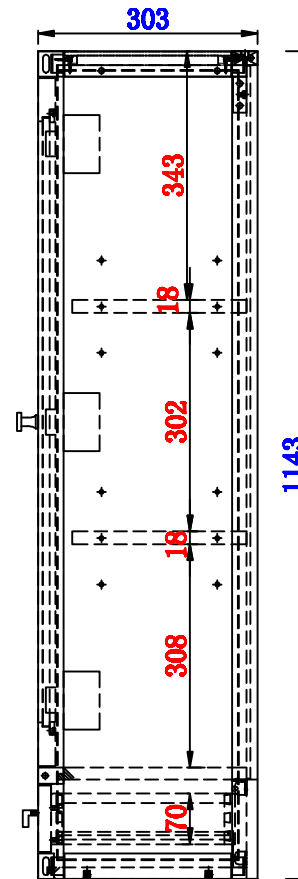
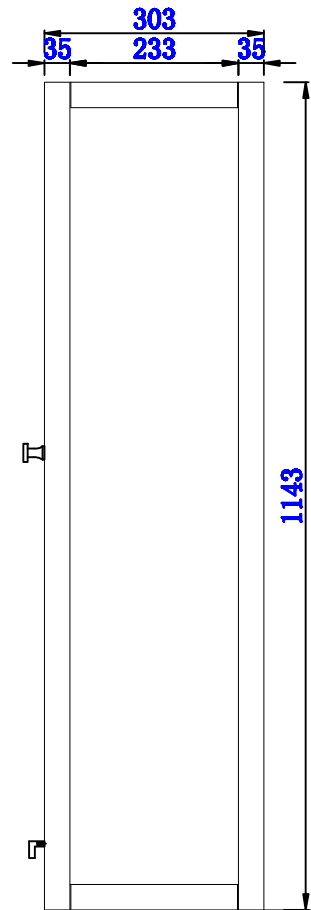

36"

Item Number:
E444-M36-MCA
E444-M36-GW

JAMES MARTIN

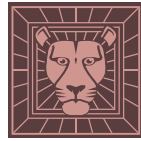

VANITIES™

Addison 36" Mirror
Diagrams with Dimensions
page 01 of 01

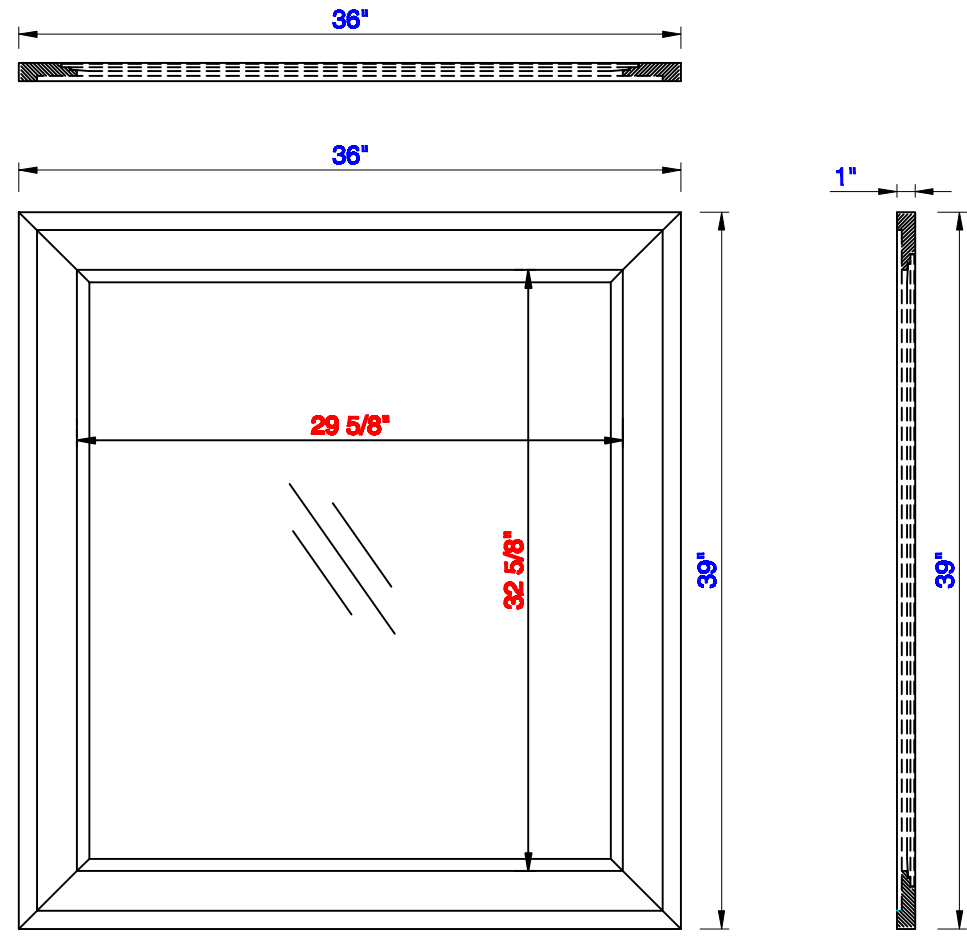

914mm

Item Number:
E444-M36-MCA
E444-M36-GW

JAMES MARTIN

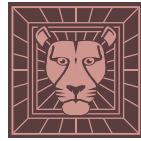

VANITIES™

Addison 914mm Mirror
Diagrams with Dimensions
page 01 of 01

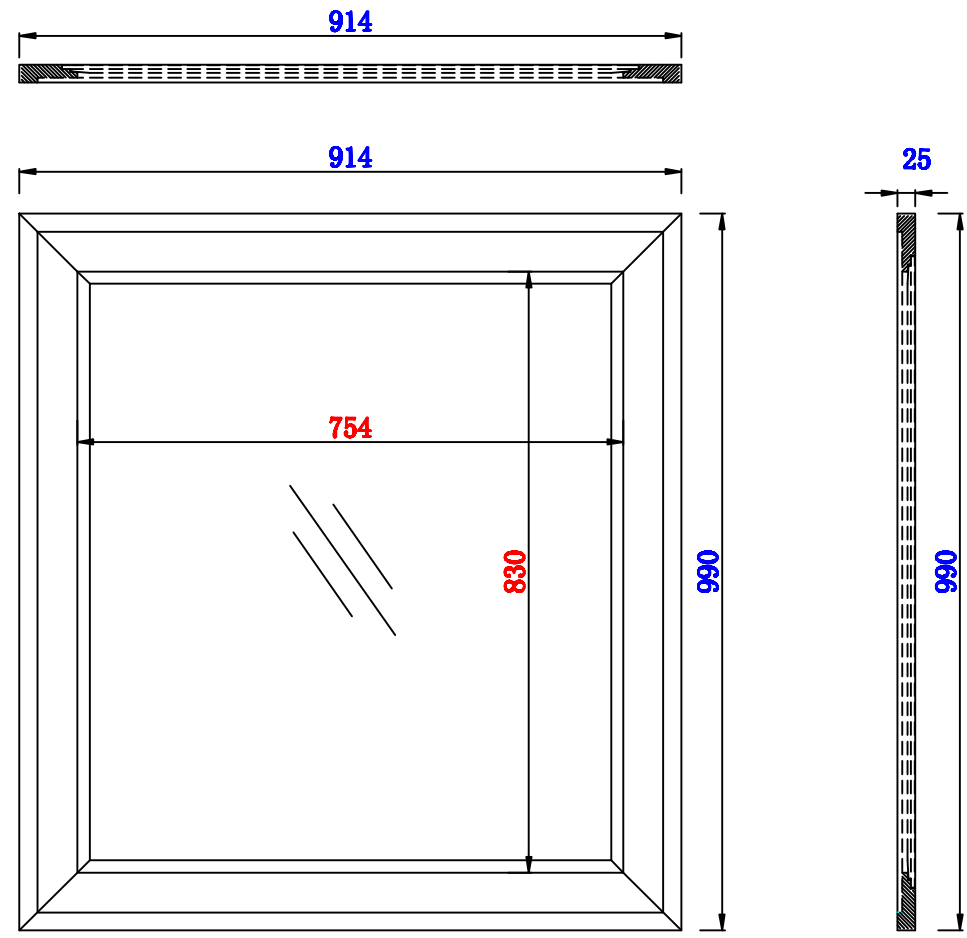



36" Vanity Top Spec Sheet

James Martin Vanities Company always recommends you consult and/or hire a professional contractor when installing your vanity cabinet and top.

3cm/1.18"
Countertop

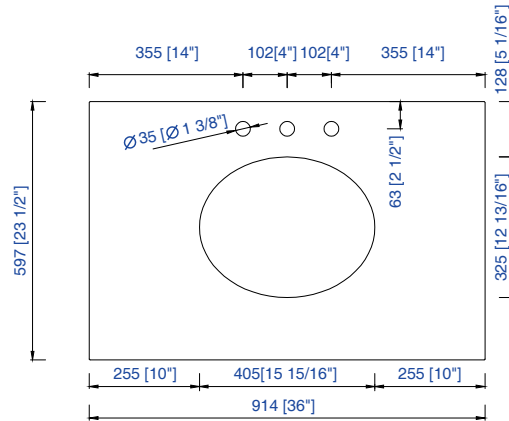

James Martin - Natural Stone Countertop Measurement Specification

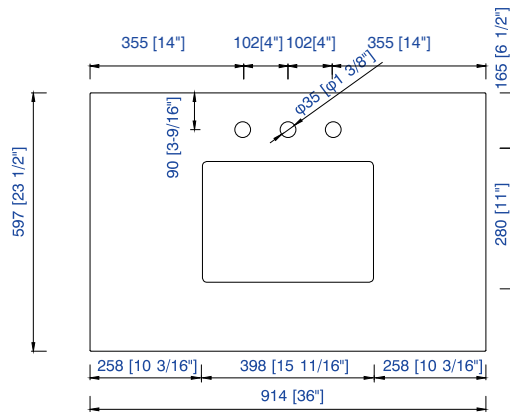

James Martin - Natural Stone & Solid Surface Countertop Measurement Specification

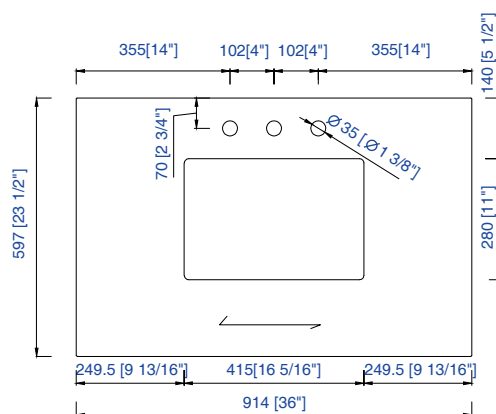

James Martin - Quartz Countertop Measurement Specification

15"

Item Number:
050-T15-CLW
050-T15-CSP
050-T15-EJP
050-T15-GEX
080-T15-AF
090-T15-CAR

JAMES MARTIN



VANITIES™

15" Top for Makeup Counter
Diagrams with Dimensions
page 01 of 01

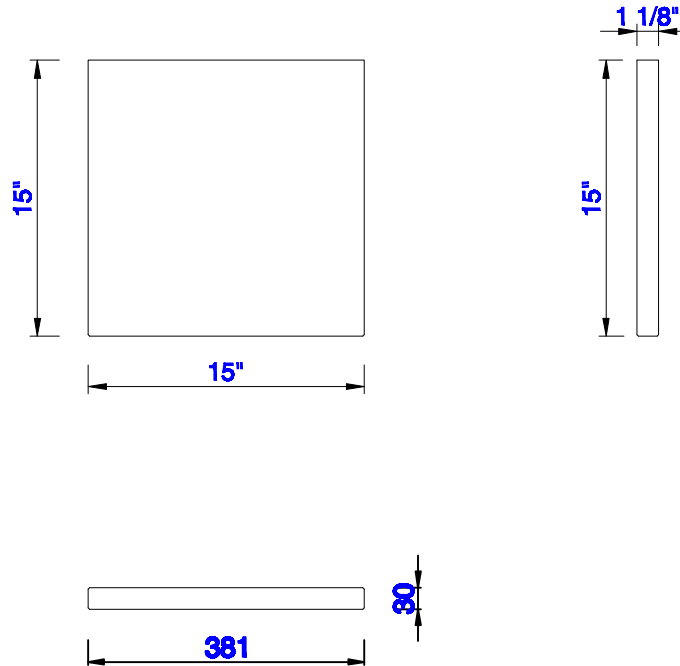

381mm

Item Number:
050-T15-CLW
050-T15-CSP
050-T15-EJP
050-T15-GEX
080-T15-AF
090-T15-CAR

JAMES MARTIN



VANITIES™

381mm Top for Makeup Counter
Diagrams with Dimensions
page 01 of 01

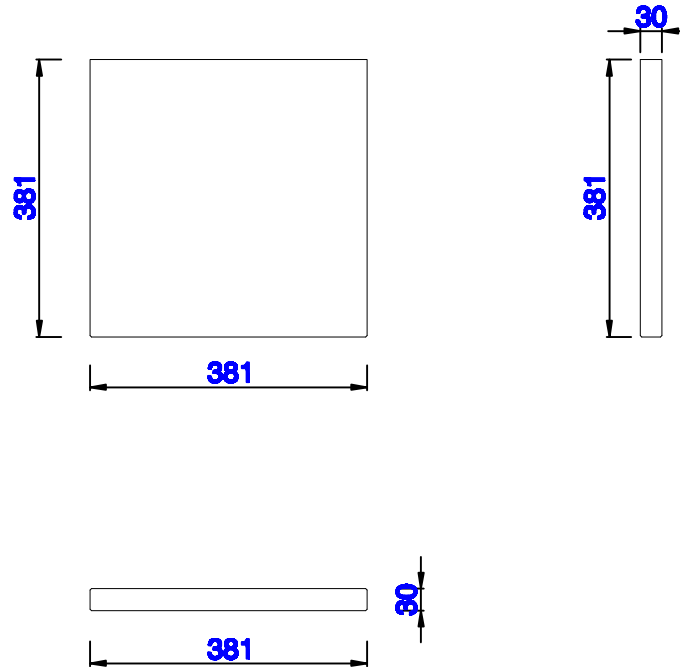



James Martin Vanities - Nova Rectangular Undermount Sink (Basin) **SNK-RCT-WHT**

Used with 3cm thickness premium rectangular countertops:
Silestone Quartz

Imperial Measurements

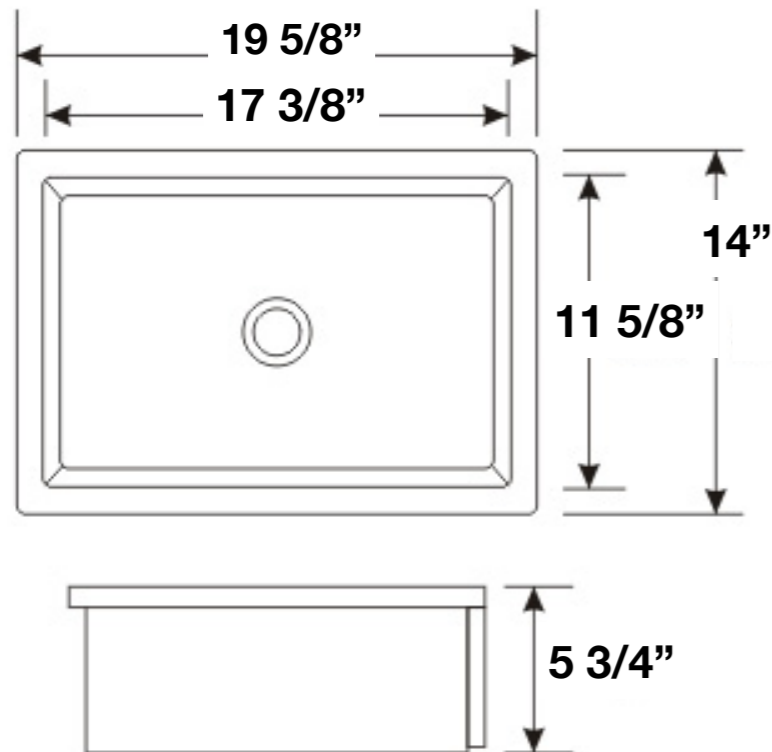

Metric Measurements

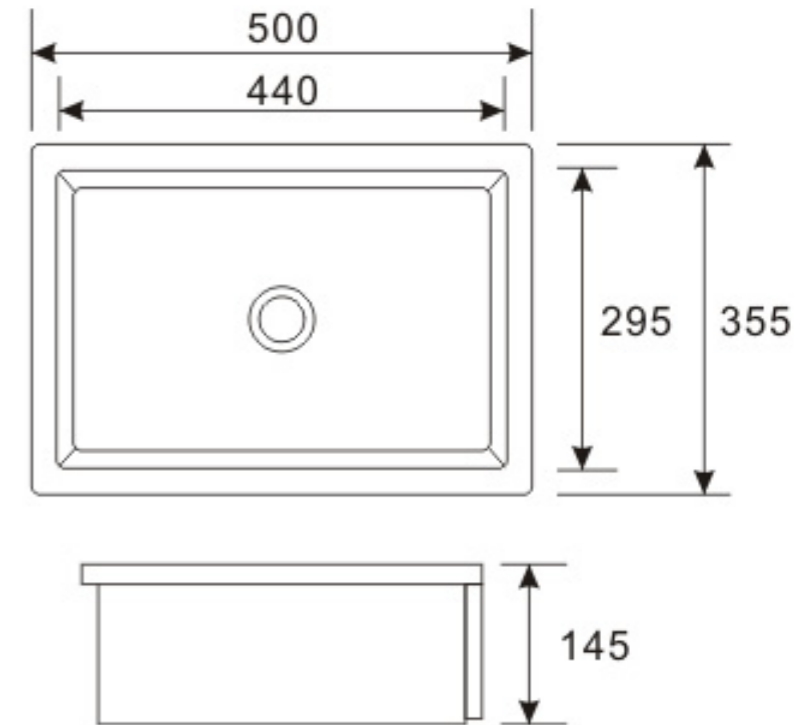

OD Size: 500 x 355 x 145 mm
 19 5/8" x 14" x 5 6/8"
 ID Size: 440 x 295 mm
 17 3/8" x 11 5/8"

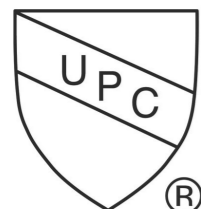

Complies with:
 ASME A112.19.2-2013
 CSA B45.1-13

white

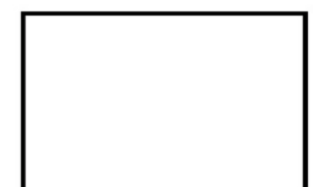

2018 Rv.