

36"

Item Number:

238-104-5511
238-104-V36-CWH
238-104-V36-UGR

JAMES MARTIN



VANITIES

Savannah 36" Cabinet

Diagrams with Dimensions
page 01 of 03

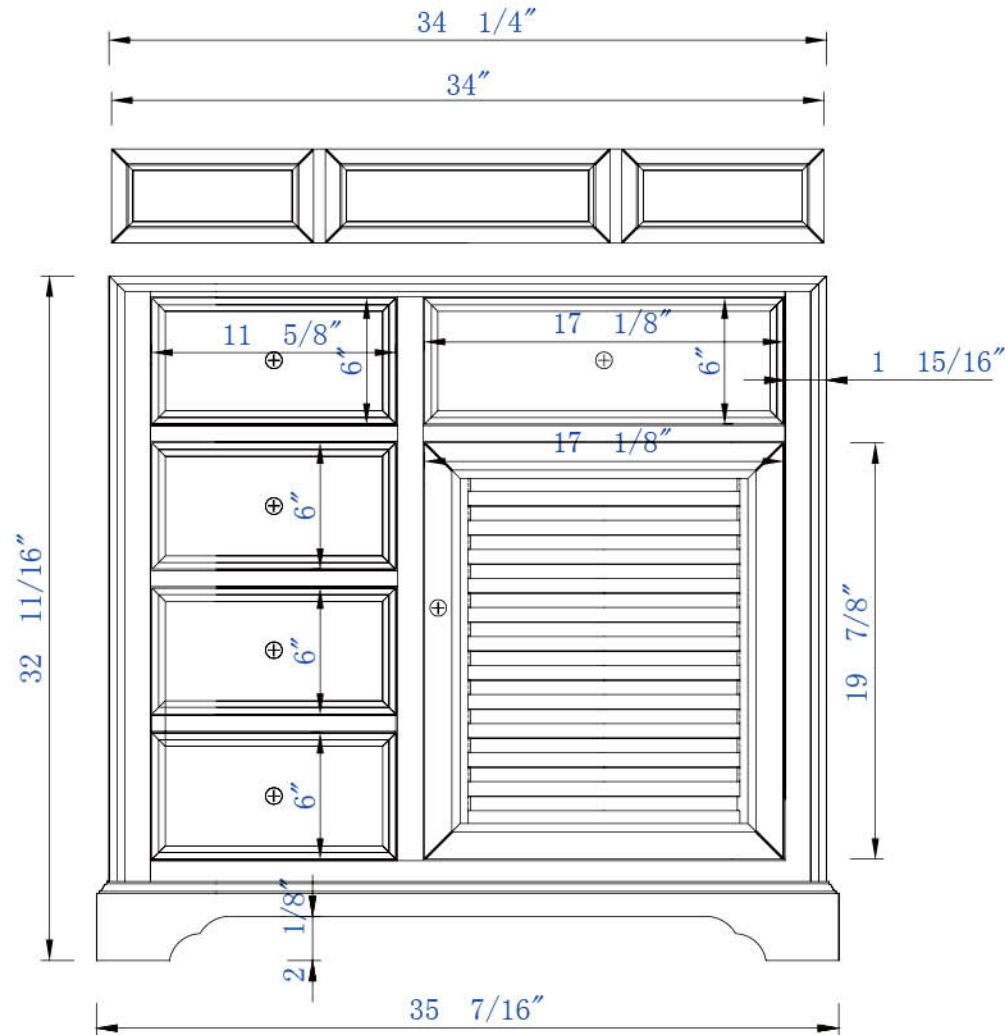

NOTE ONE: Countertops are not shown in these diagrams. (Cabinet Only)

NOTE TWO: Wood Backsplash (Shown) is designed for the molding detail to align with sinks in James Martin's Optional Countertops.

Customers' own countertops and sinks may align differently.

Please consult our website for Countertop Diagrams: www.jamesmartinvanities.com

36"

Item Number:

238-104-5511
238-104-V36-CWH
238-104-V36-UGR

JAMES MARTIN



VANITIES

Savannah 36" Cabinet

Diagrams with Dimensions
page 02 of 03

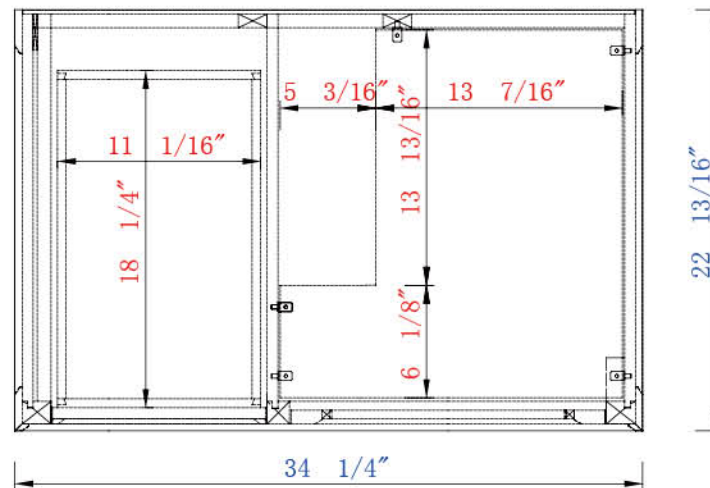
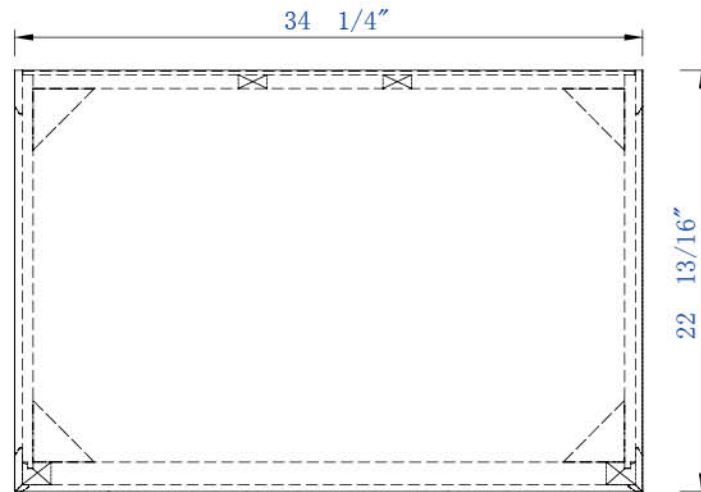

NOTE ONE: Countertops are not shown in these diagrams. (Cabinet Only)

NOTE TWO: Internal Shelves (Shown) are designed to align with sinks in James Martin's Optional Countertops.

Customers' own countertops and sinks may align differently, and modification may be required.

Please consult our website for Countertop Diagrams: www.jamesmartinvanities.com

36"

Item Number:

238-104-5511
238-104-V36-CWH
238-104-V36-UGR

JAMES MARTIN



VANITIES

Savannah 36" Cabinet

Diagrams with Dimensions
page 03 of 03

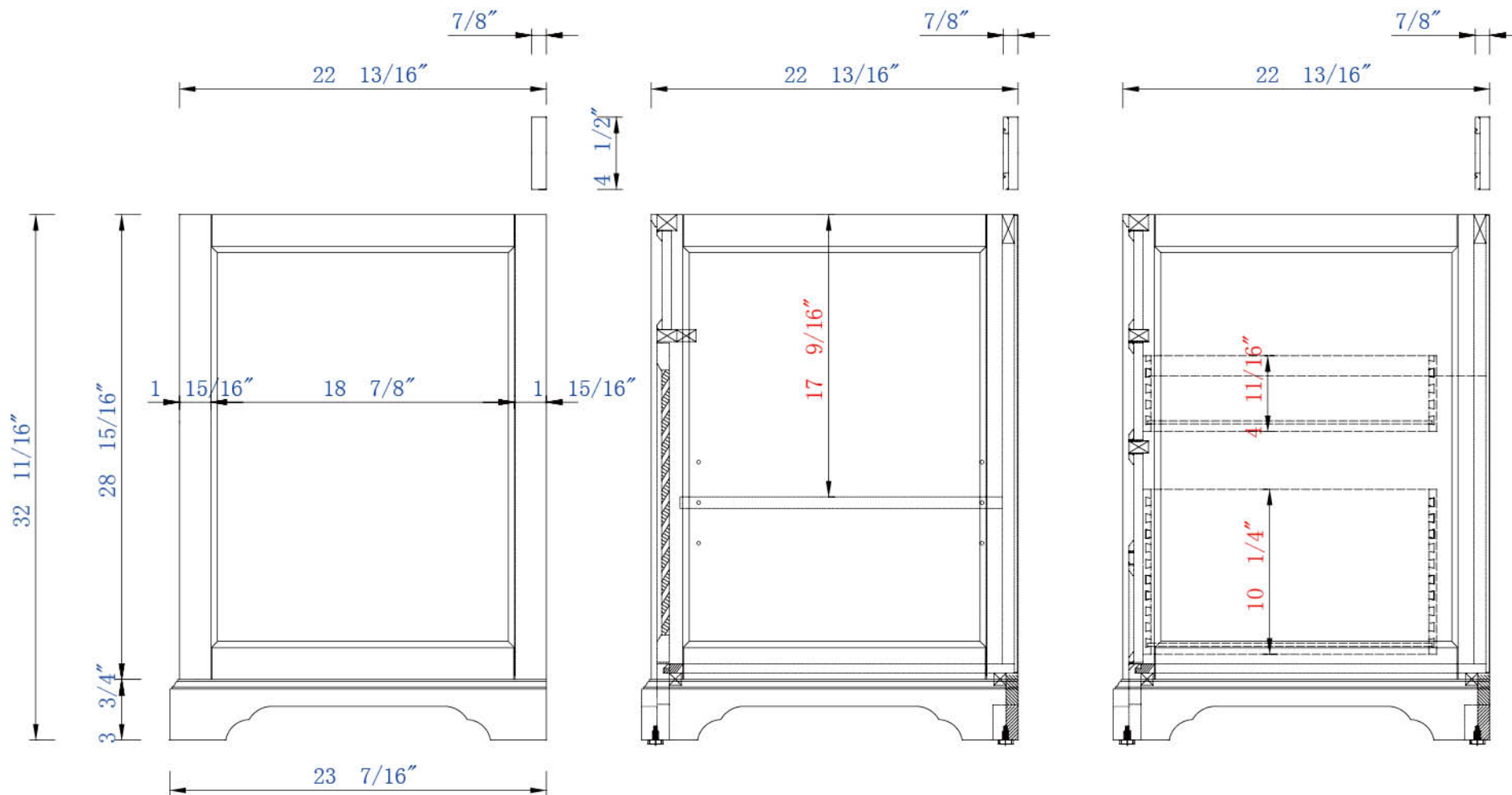

NOTE ONE: Countertops are not shown in these diagrams. (Cabinet Only)

NOTE TWO: Wood Backsplash (Shown) is designed for the molding detail to align with sinks in James Martin's Optional Countertops.

Customers' own countertops and sinks may align differently.

Please consult our website for Countertop Diagrams: www.jamesmartinvanities.com

914mm

Item Number:

238-104-5511
238-104-V36-CWH
238-104-V36-UGR

JAMES MARTIN



VANITIES

Savannah 914mm Cabinet

Diagrams with Dimensions
page 01 of 03

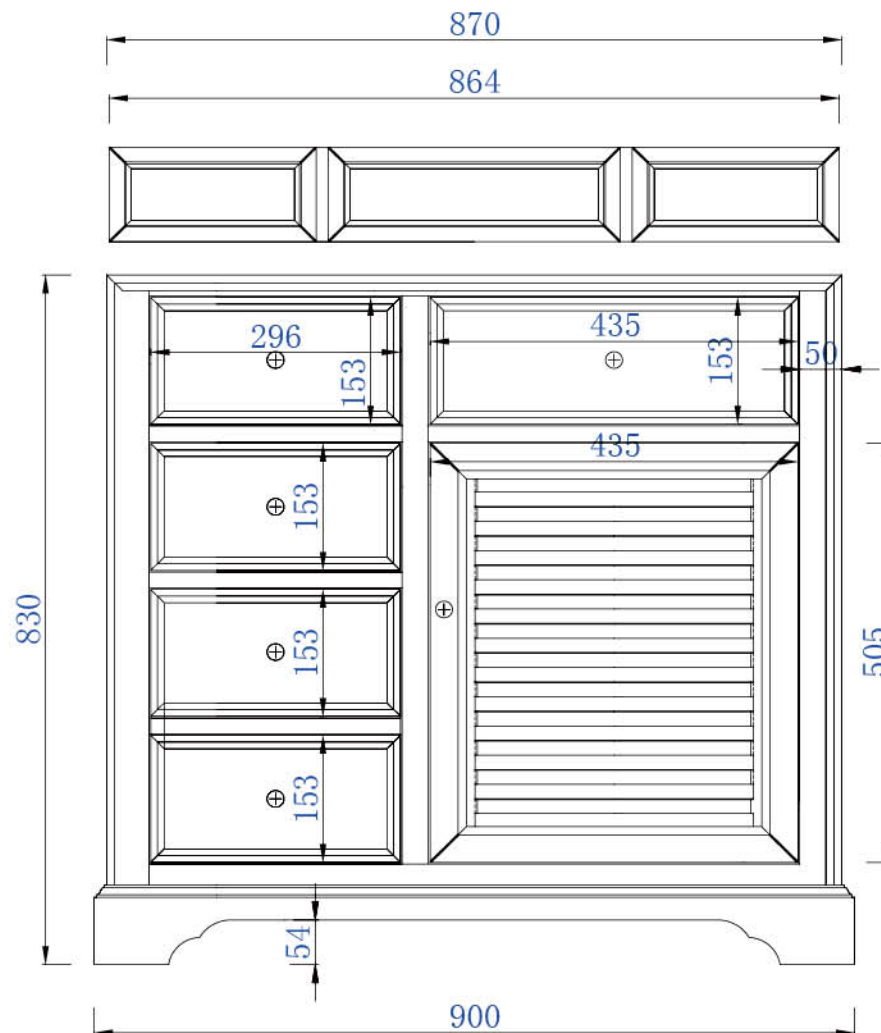

NOTE ONE: Countertops are not shown in these diagrams. (Cabinet Only)

NOTE TWO: Wood Backsplash (Shown) is designed for the molding detail to align with sinks in James Martin's Optional Countertops.

Customers' own countertops and sinks may align differently.

Please consult our website for Countertop Diagrams: www.jamesmartinvanities.com

914mm

Item Number:

238-104-5511
238-104-V36-CWH
238-104-V36-UGR

JAMES MARTIN



VANITIES

Savannah 914mm Cabinet

Diagrams with Dimensions
page 02 of 03

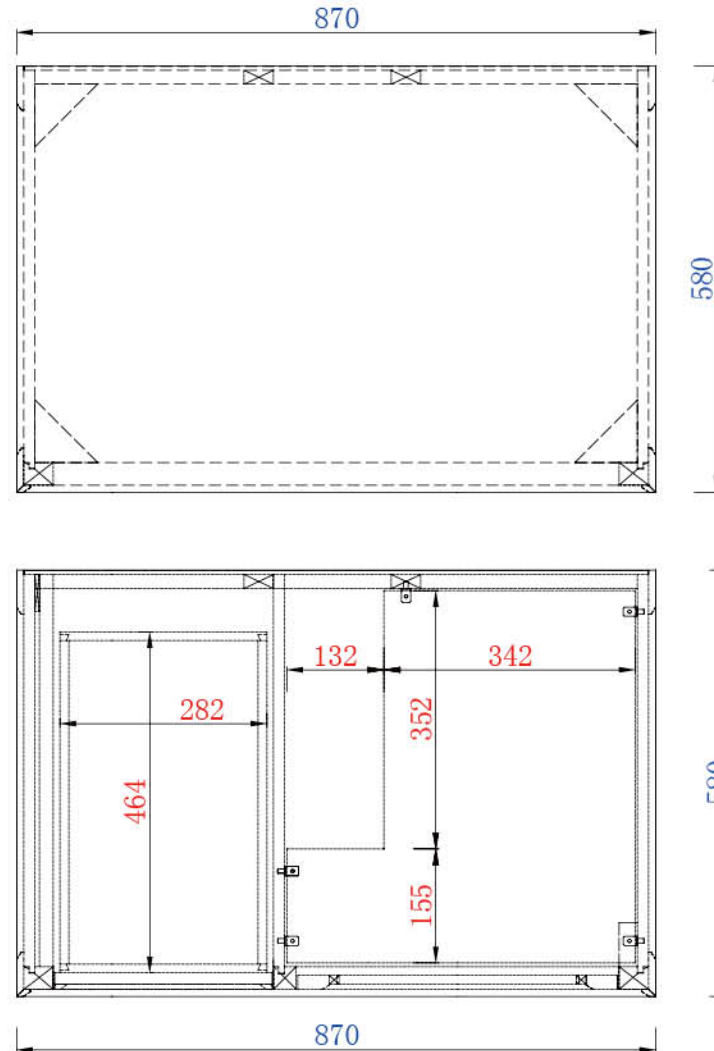

NOTE ONE: Countertops are not shown in these diagrams. (Cabinet Only)

NOTE TWO: Internal Shelves (Shown) are designed to align with sinks in James Martin's Optional Countertops.

Customers' own countertops and sinks may align differently, and modification may be required.

Please consult our website for Countertop Diagrams: www.jamesmartinvanities.com

914mm

Item Number:

238-104-5511
238-104-V36-CWH
238-104-V36-UGR

JAMES MARTIN



VANITIES

Savannah 914mm Cabinet

Diagrams with Dimensions
page 03 of 03

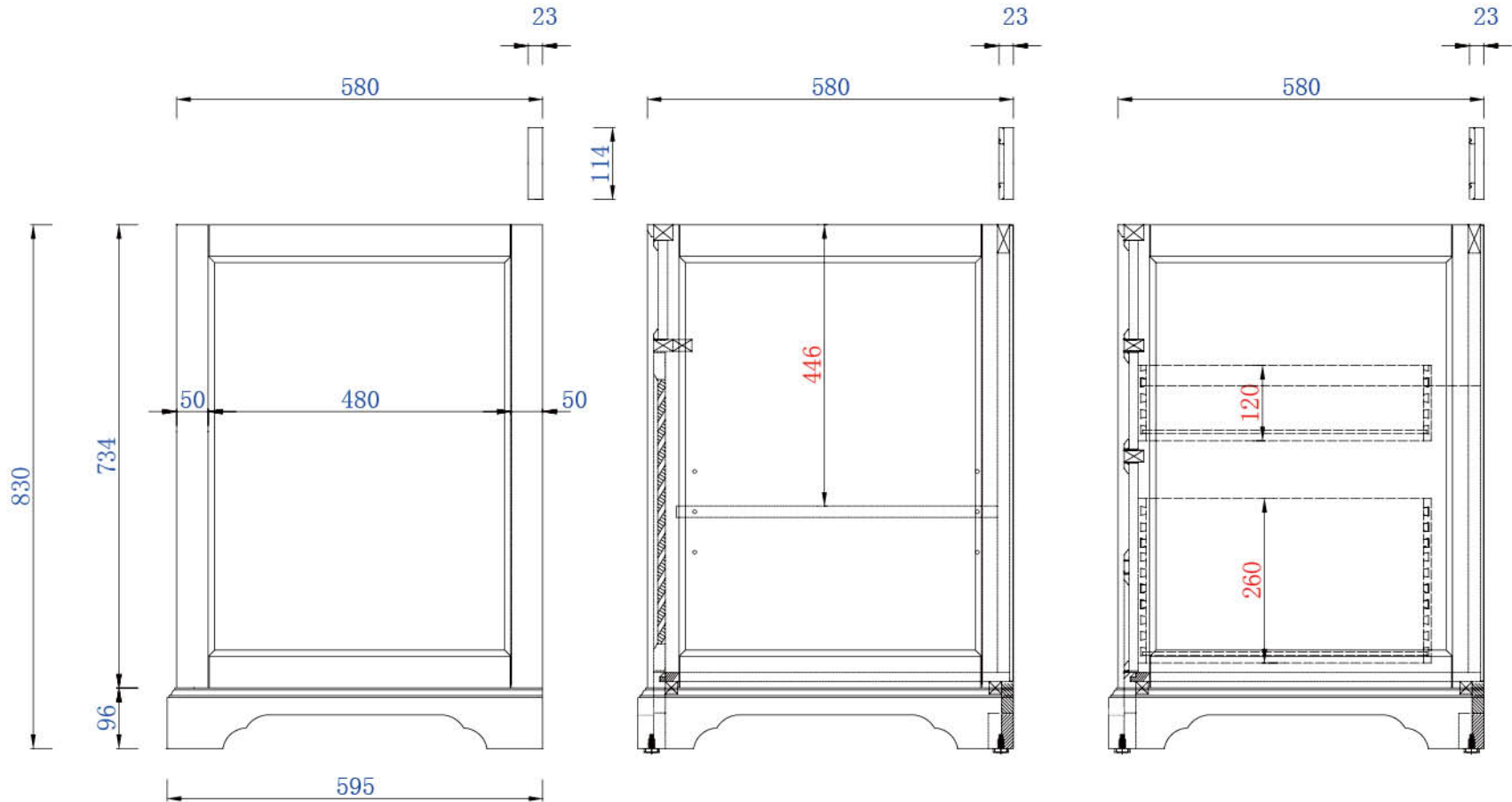

NOTE ONE: Countertops are not shown in these diagrams. (Cabinet Only)

NOTE TWO: Wood Backsplash (Shown) is designed for the molding detail to align with sinks in James Martin's Optional Countertops.

Customers' own countertops and sinks may align differently.

Please consult our website for Countertop Diagrams: www.jamesmartinvanities.com