

60" S

Item Number:

527-V60S-BW  
527-V60S-SL

JAMES MARTIN



VANITIES

Palisades 60" Single Vanity

Diagrams with Dimensions  
page 01 of 03

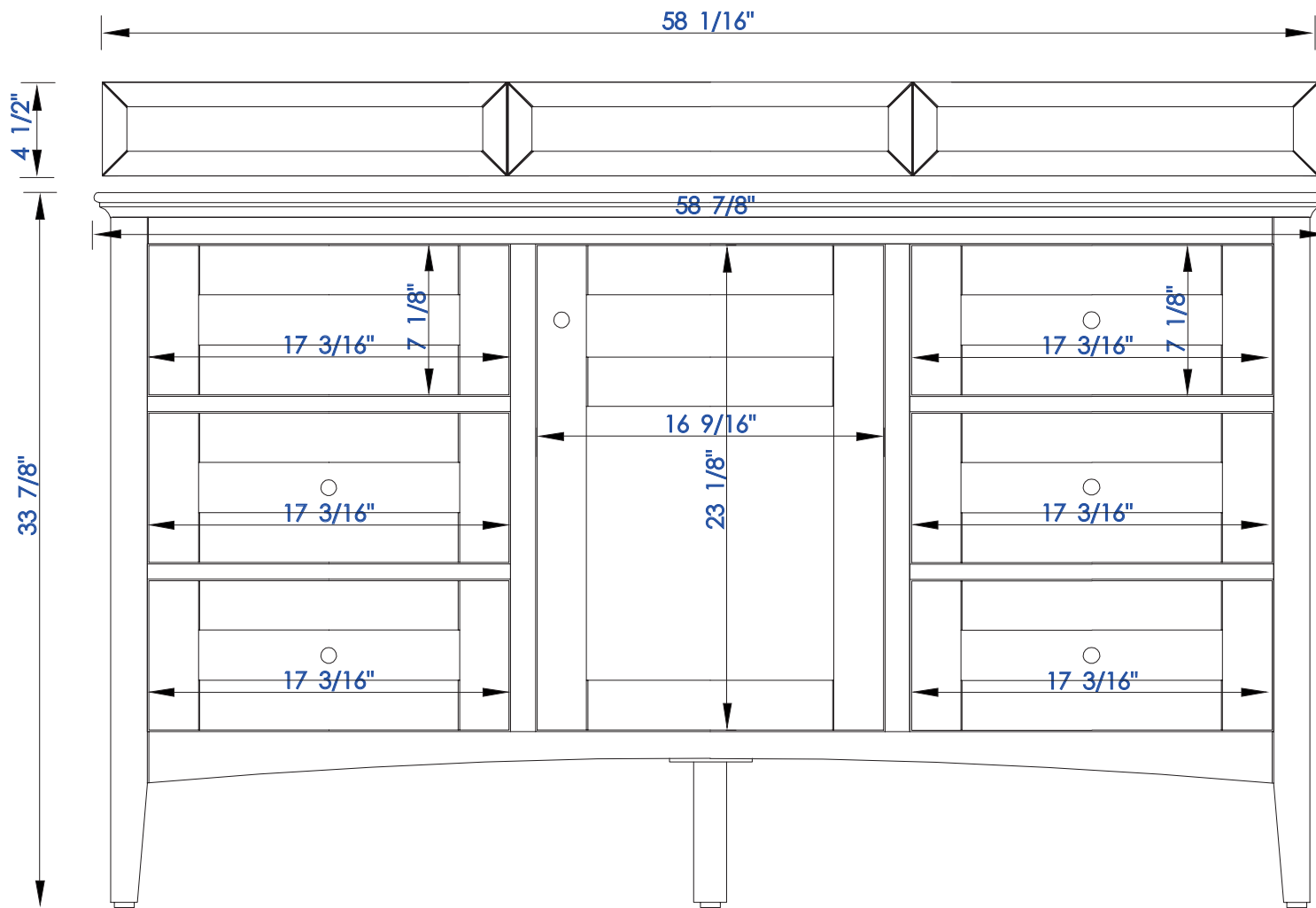

NOTE ONE: Countertops are not shown in these diagrams. (Cabinet Only)

NOTE TWO: Wood Backsplash (Shown) is designed for the molding detail to align with sinks in James Martin's Optional Countertops.

Customer's own countertops and sinks may align differently, and modification may be required.

Please consult our website for Countertop Diagrams: [www.jamesmartinvanities.com](http://www.jamesmartinvanities.com)

60" S

Item Number:

527-V60S-BW  
527-V60S-SL

JAMES MARTIN



VANITIES

Palisades 60" Single Vanity

Diagrams with Dimensions  
page 02 of 03

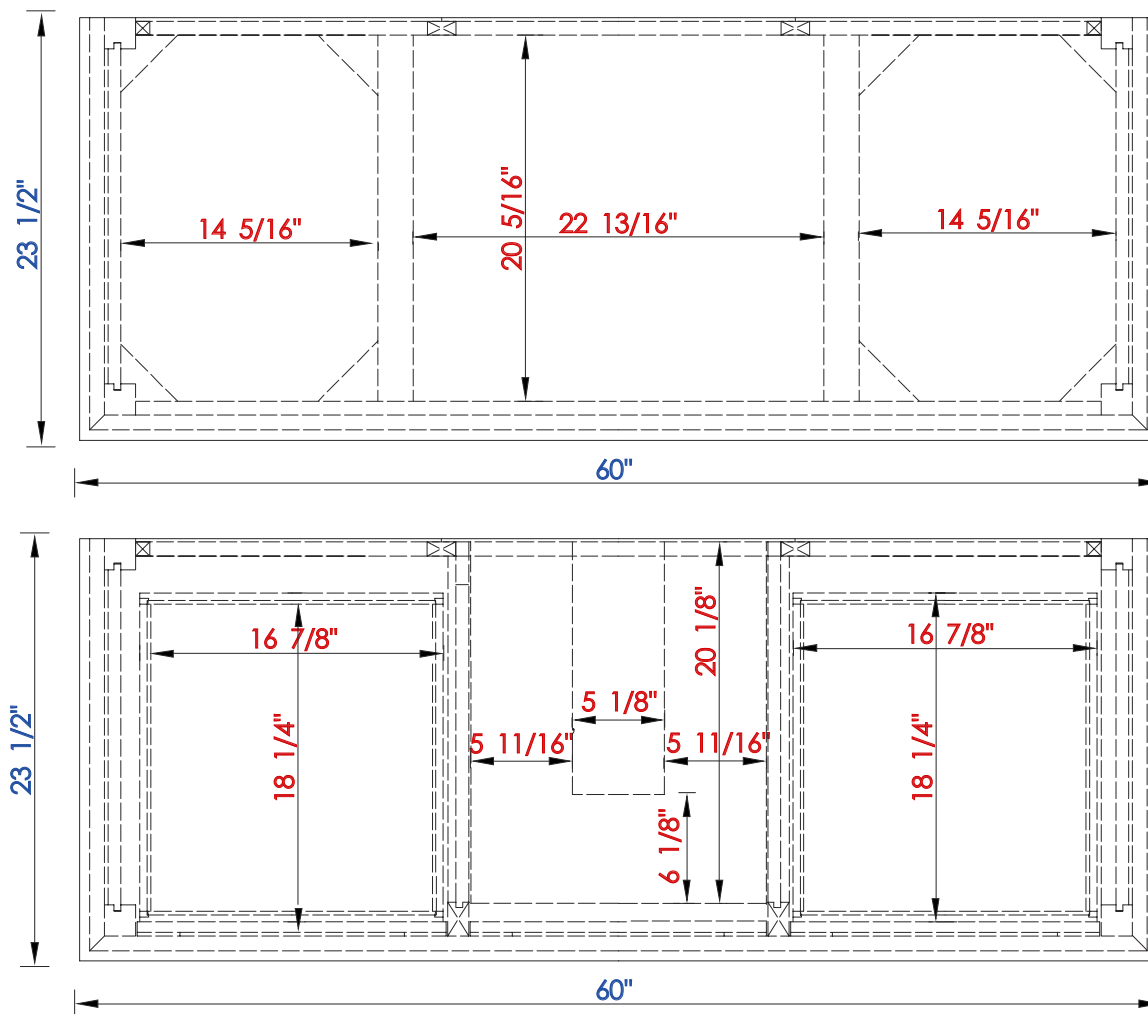

NOTE ONE: Countertops are not shown in these diagrams. (Cabinet Only)

NOTE TWO: Internal Shelves(Shown) are designed to align with sinks in James Martin's Optional Countertops.

Customer's own countertops and sink may align differently, and modification may be required.

Please consult our website for Countertop Diagrams: [www.jamesmartinvanities.com](http://www.jamesmartinvanities.com)

60" S

Item Number:

527-V60S-BW  
527-V60S-SL

JAMES MARTIN



VANITIES

Palisades 60" Single Vanity

Diagrams with Dimensions  
page 03 of 03

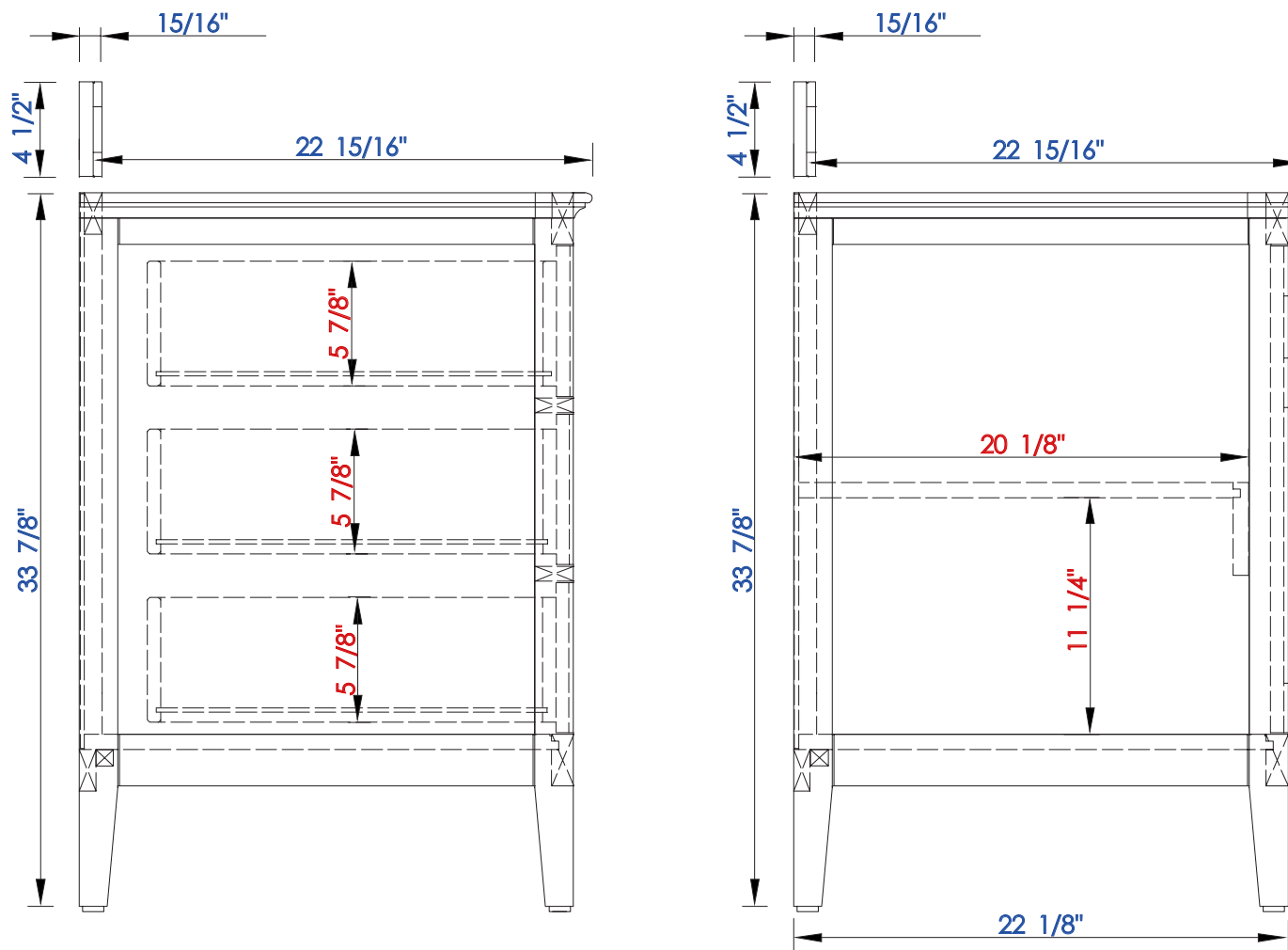

NOTE ONE: Countertops are not shown in these diagrams. (Cabinet Only)

NOTE TWO: Wood Backsplash (Shown) is designed for the molding detail to align with sinks in James Martin's Optional Countertops.

Customer's own countertops and sinks may align differently, and modification may be required.

Please consult our website for Countertop Diagrams: [www.jamesmartinvanities.com](http://www.jamesmartinvanities.com)

1524 mm

Item Number:

527-V60S-BW  
527-V60S-SL

JAMES MARTIN



VANITIES

Palisades 1524mm Single Vanity

Diagrams with Dimensions  
page 01 of 03

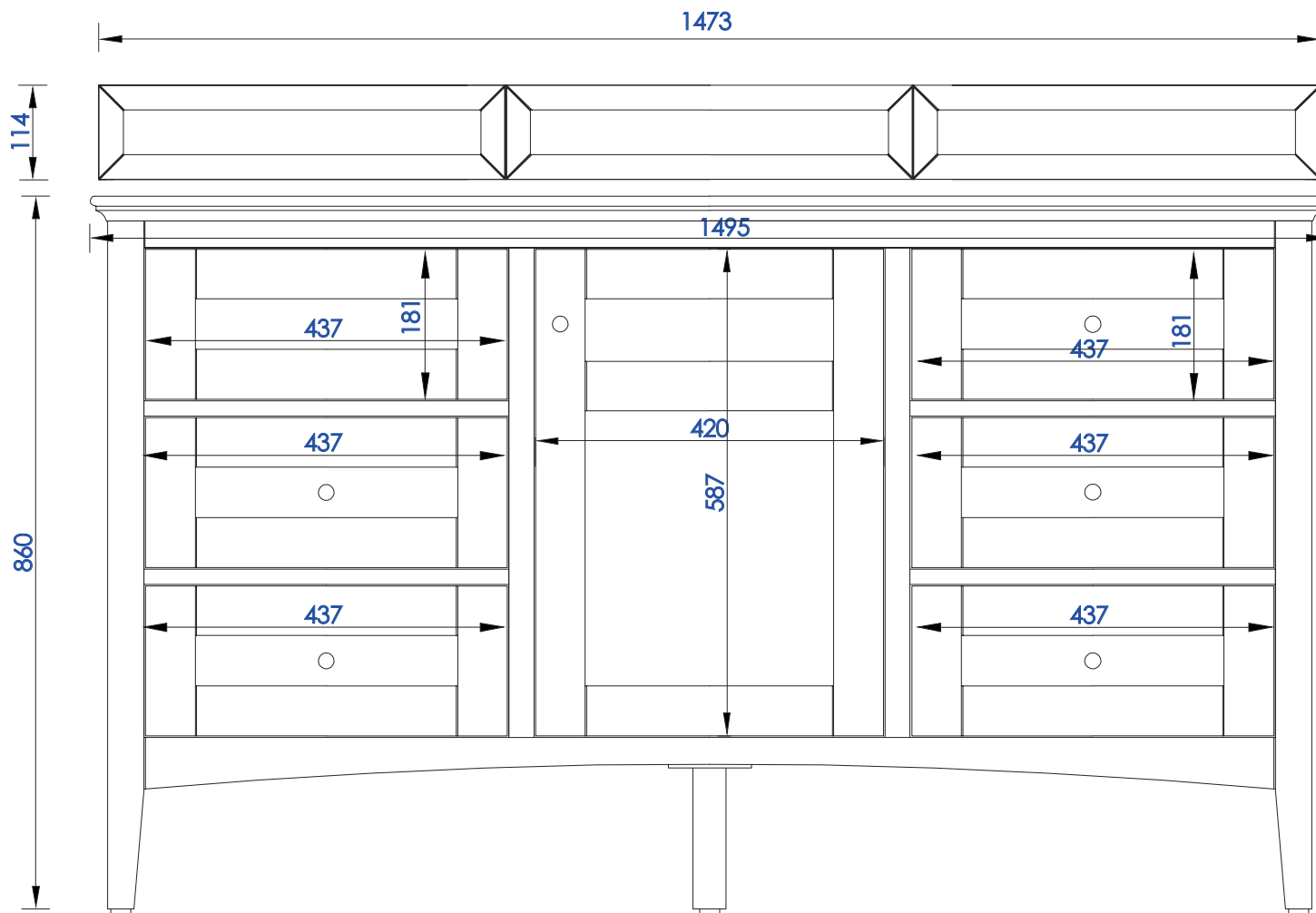

NOTE ONE: Countertops are not shown in these diagrams. (Cabinet Only)

NOTE TWO: Wood Backsplash (Shown) is designed for the molding detail to align with sinks in James Martin's Optional Countertops.

Customer's own countertops and sinks may align differently, and modification may be required.

Please consult our website for Countertop Diagrams: [www.jamesmartinvanities.com](http://www.jamesmartinvanities.com)

1524 mm

Item Number:

527-V60S-BW  
527-V60S-SL

JAMES MARTIN



VANITIES

Palisades 1524mm Single Vanity

Diagrams with Dimensions  
page 02 of 03

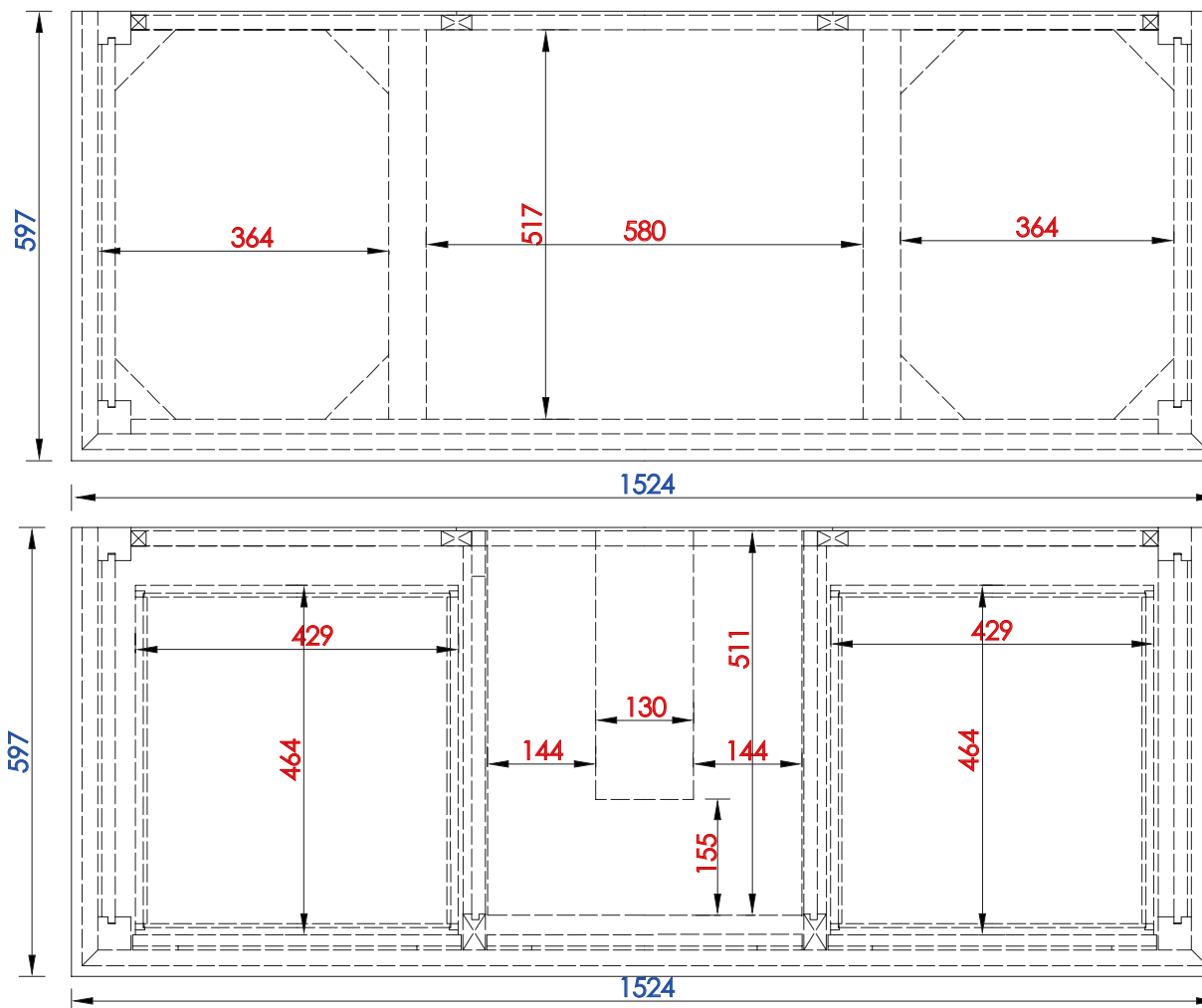

NOTE ONE: Countertops are not shown in these diagrams. (Cabinet Only)

NOTE TWO: Internal Shelves(Shown) are designed to align with sinks in James Martin's Optional Countertops.

Customer's own countertops and sink may align differently, and modification may be required.

Please consult our website for Countertop Diagrams: [www.jamesmartinvanities.com](http://www.jamesmartinvanities.com)

1524 mm

Item Number:

527-V60S-BW  
527-V60S-SL

JAMES MARTIN



VANITIES

Palisades 1524mm Single Vanity

Diagrams with Dimensions  
page 03 of 03

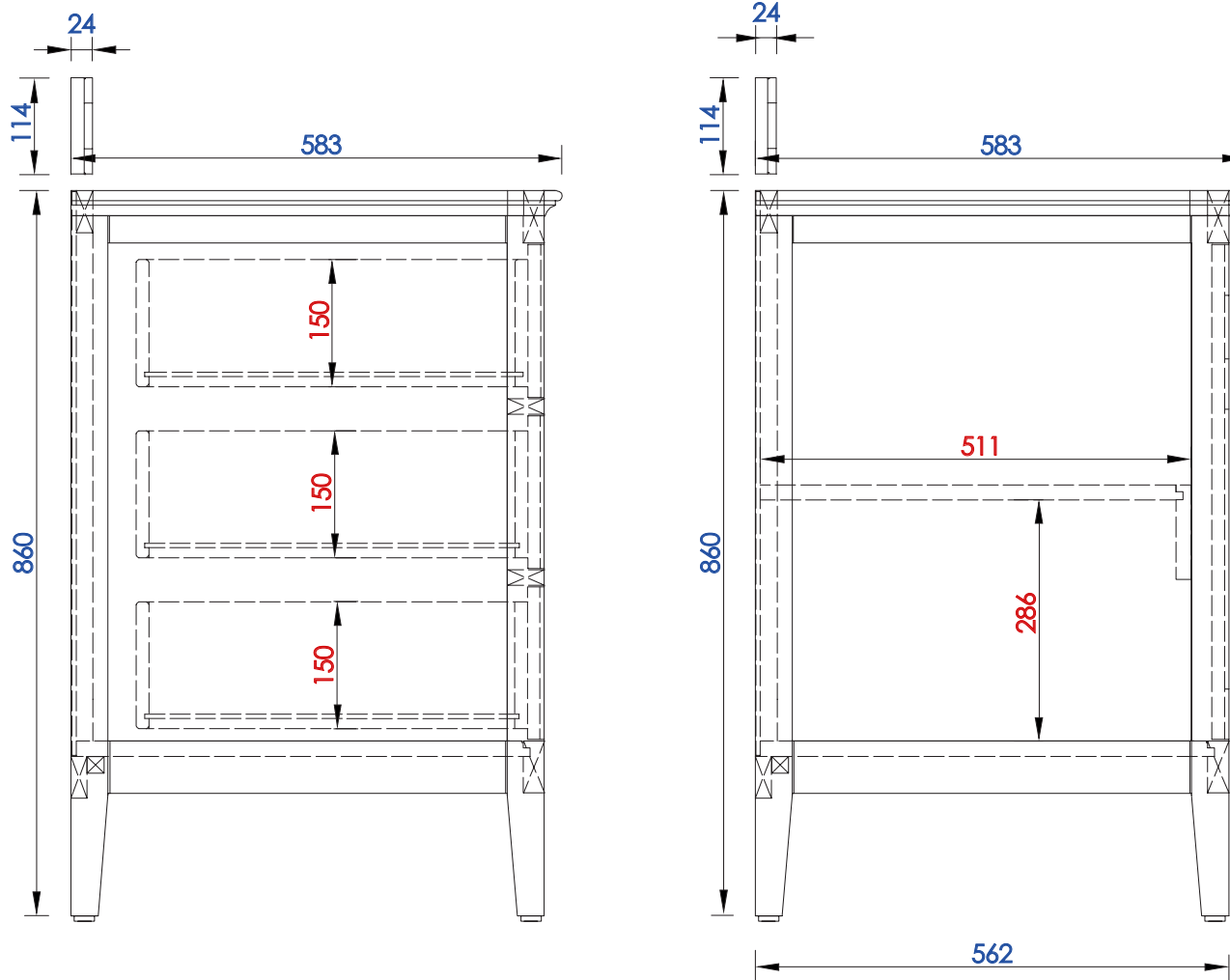

NOTE ONE: Countertops are not shown in these diagrams. (Cabinet Only)

NOTE TWO: Wood Backsplash (Shown) is designed for the molding detail to align with sinks in James Martin's Optional Countertops.

Customer's own countertops and sinks may align differently, and modification may be required.

Please consult our website for Countertop Diagrams: [www.jamesmartinvanities.com](http://www.jamesmartinvanities.com)

60"S

Item Number:

527-V60S-BW  
527-V60S-SL

JAMES MARTIN



VANITIES

Palisades 60" Single Vanity

Diagrams with Dimensions  
page 01 of 01

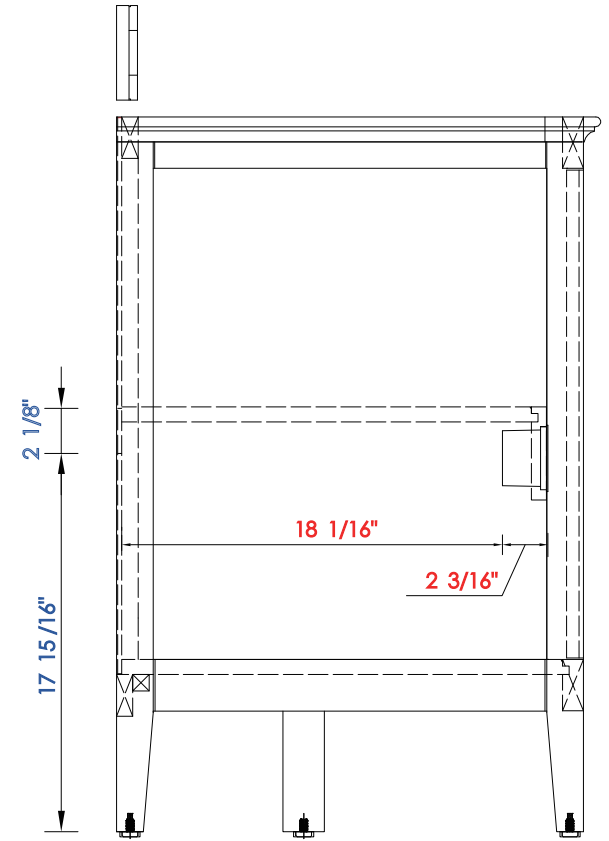
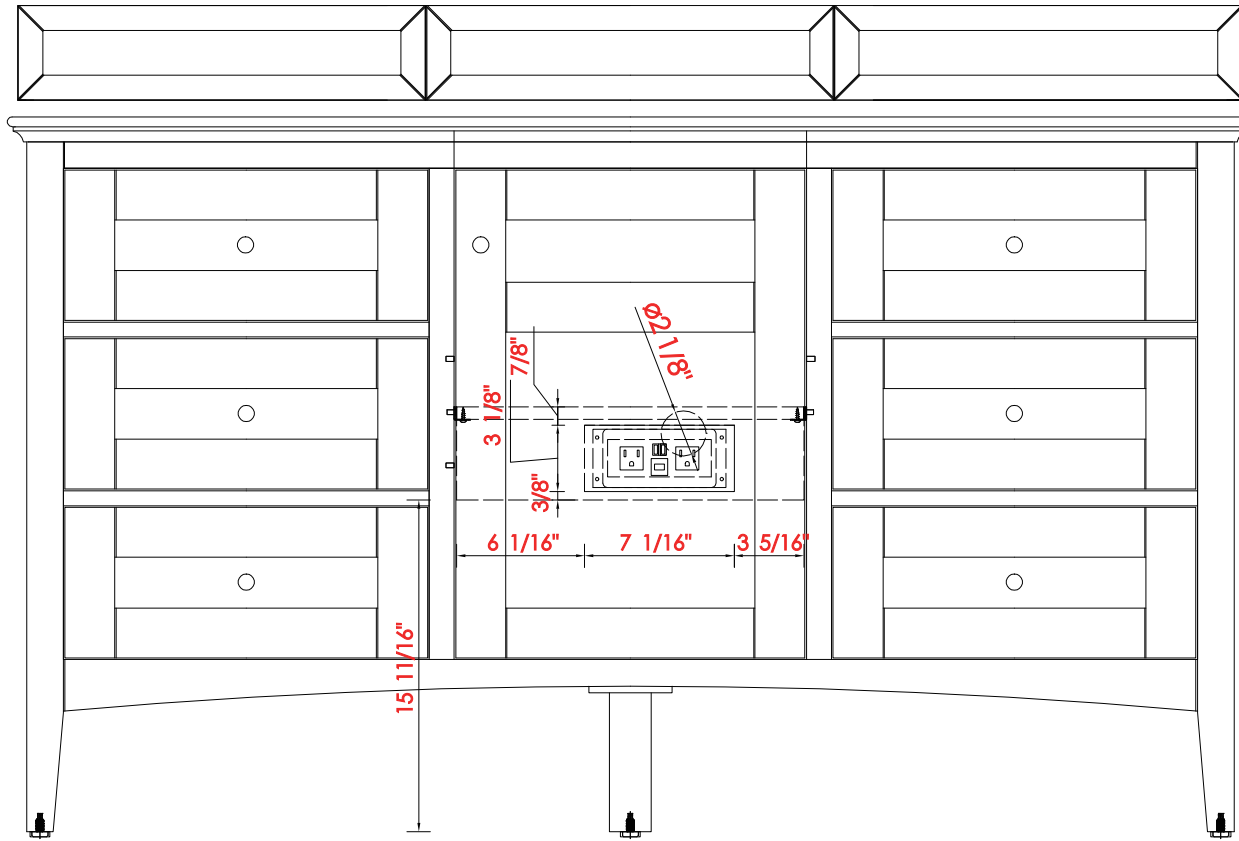

1524 mm

Item Number:

527-V60S-BW  
527-V60S-SL

JAMES MARTIN



VANITIES

### Palisades 1524mm Single Vanity

Diagrams with Dimensions  
page 01 of 01

