

60" S

Item Number:

825-V60S-BNM
825-V60S-BW
825-V60S-SL

JAMES MARTIN



VANITIES

De Soto 60" Single Vanity

Diagrams with Dimensions
page 01 of 03

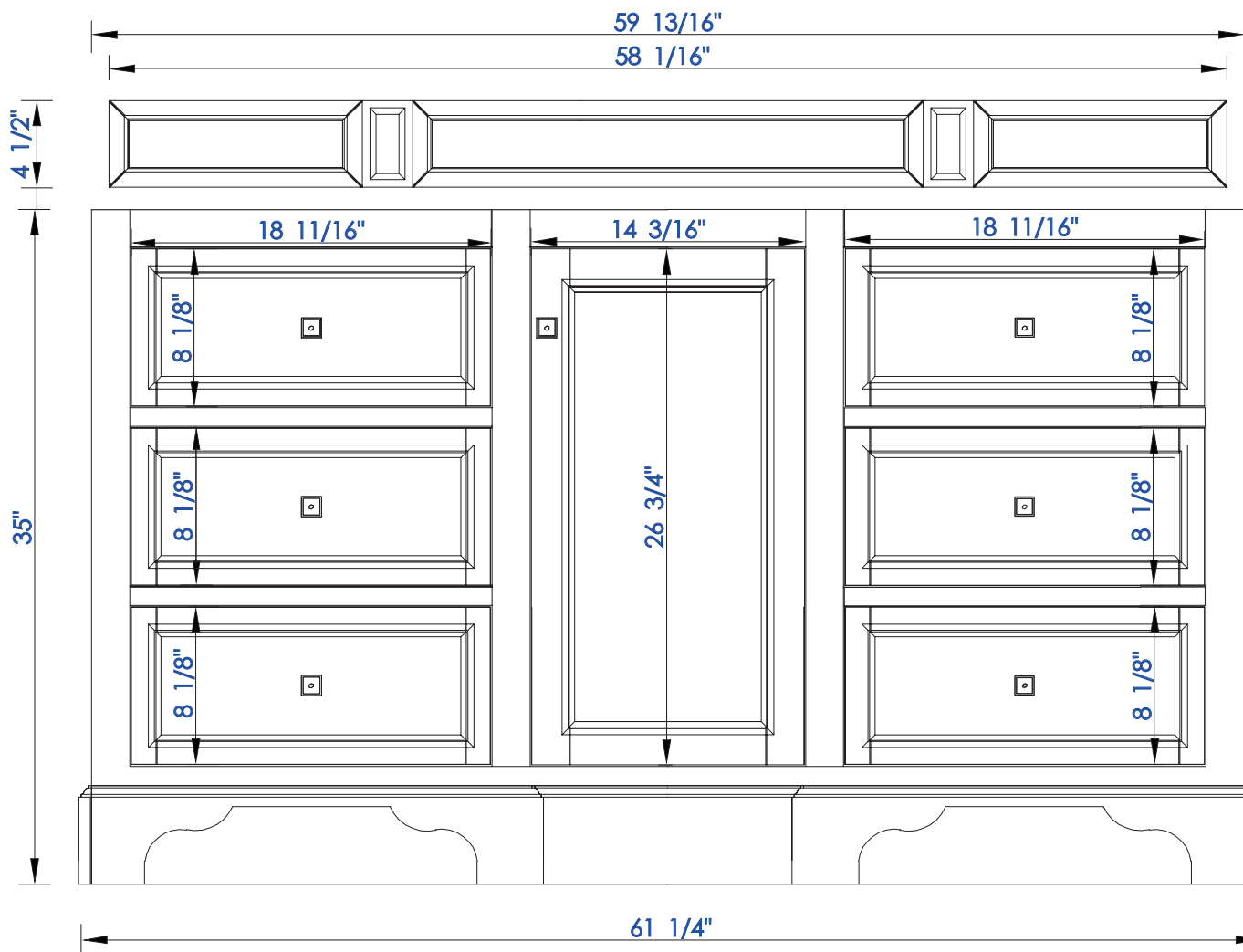

NOTE ONE: Countertops are not shown in these diagrams. (Cabinet Only)

NOTE TWO: Wood Backsplash (Shown) is designed for the molding detail to align with sinks in James Martin's Optional Countertops.

Customer's own countertops and sinks may align differently, and modification may be required.

Please consult our website for Countertop Diagrams: www.jamesmartinvanities.com

60" S

Item Number:

825-V60S-BNM
825-V60S-BW
825-V60S-SL

JAMES MARTIN



VANITIES

De Soto 60" Single Vanity

Diagrams with Dimensions
page 02 of 03

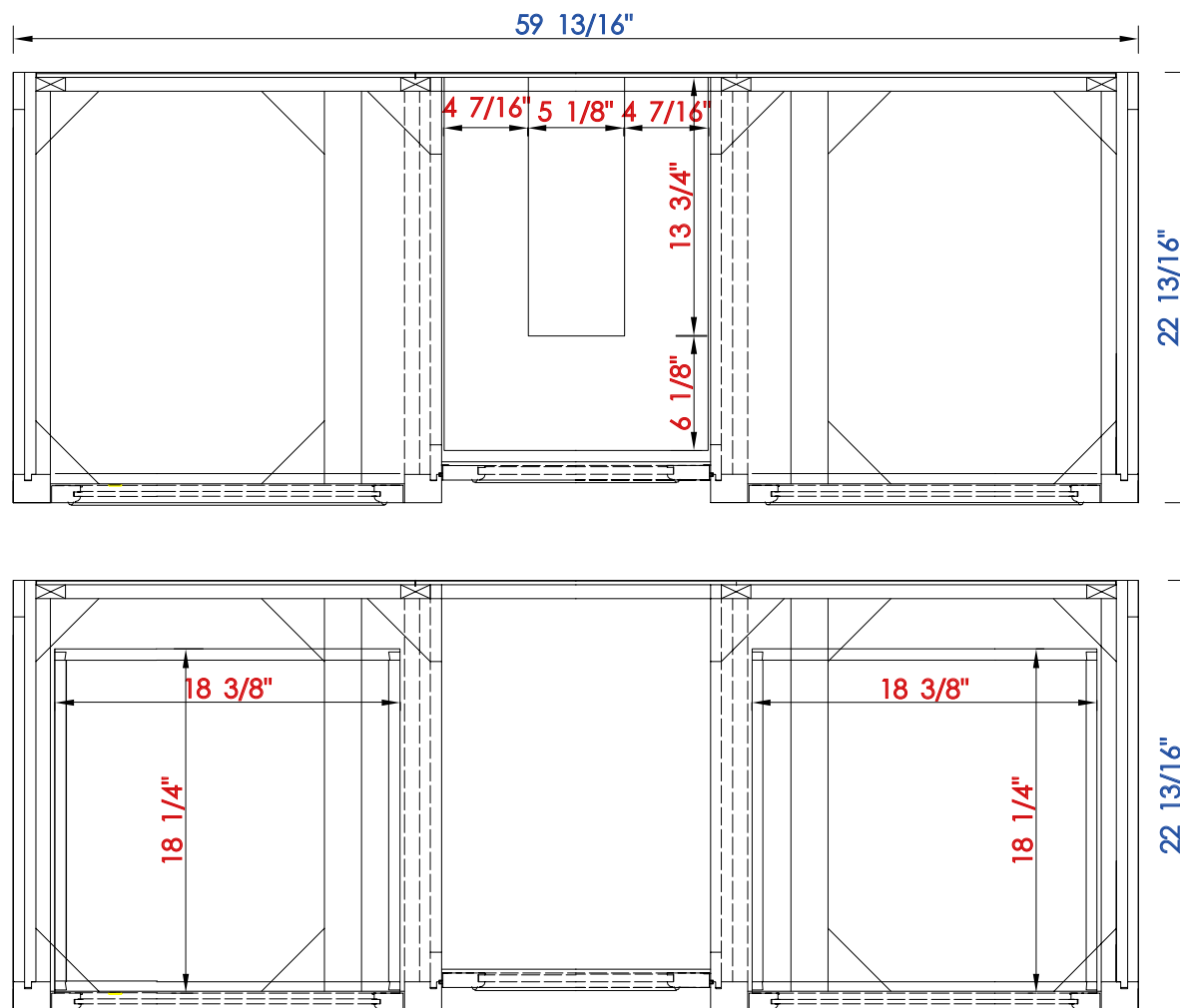

NOTE ONE: Countertops are not shown in these diagrams. (Cabinet Only)

NOTE TWO: Internal Shelves(Shown) are designed to align with sinks in James Martin's Optional Countertops.

Customer's own countertops and sink may align differently, and modification may be required.

Please consult our website for Countertop Diagrams: www.jamesmartinvanities.com

60" S

Item Number:

825-V60S-BNM
825-V60S-BW
825-V60S-SL

JAMES MARTIN



VANITIES

De Soto 60" Single Vanity

Diagrams with Dimensions
page 03 of 03

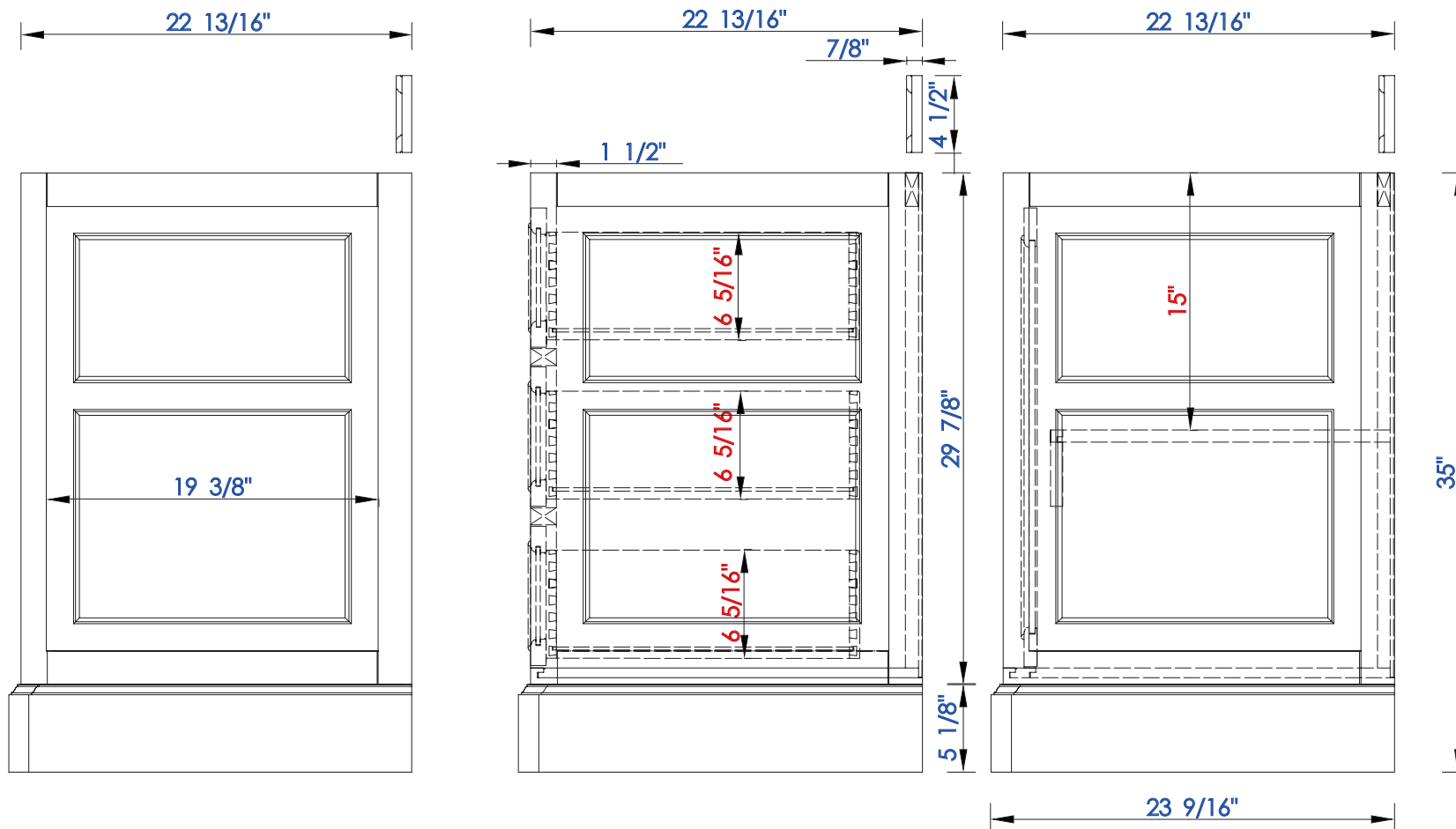

NOTE ONE: Countertops are not shown in these diagrams. (Cabinet Only)

NOTE TWO: Wood Backsplash (Shown) is designed for the molding detail to align with sinks in James Martin's Optional Countertops. Customer's own countertops and sinks may align differently, and modification may be required.

Please consult our website for Countertop Diagrams: www.jamesmartinvanities.com

1524 mm

Item Number:

JAMES MARTIN

De Soto 1524mm Single Vanity

825-V60S-BNM
825-V60S-BW
825-V60S-SL

Diagrams with Dimensions
page 01 of 03



VANITIES

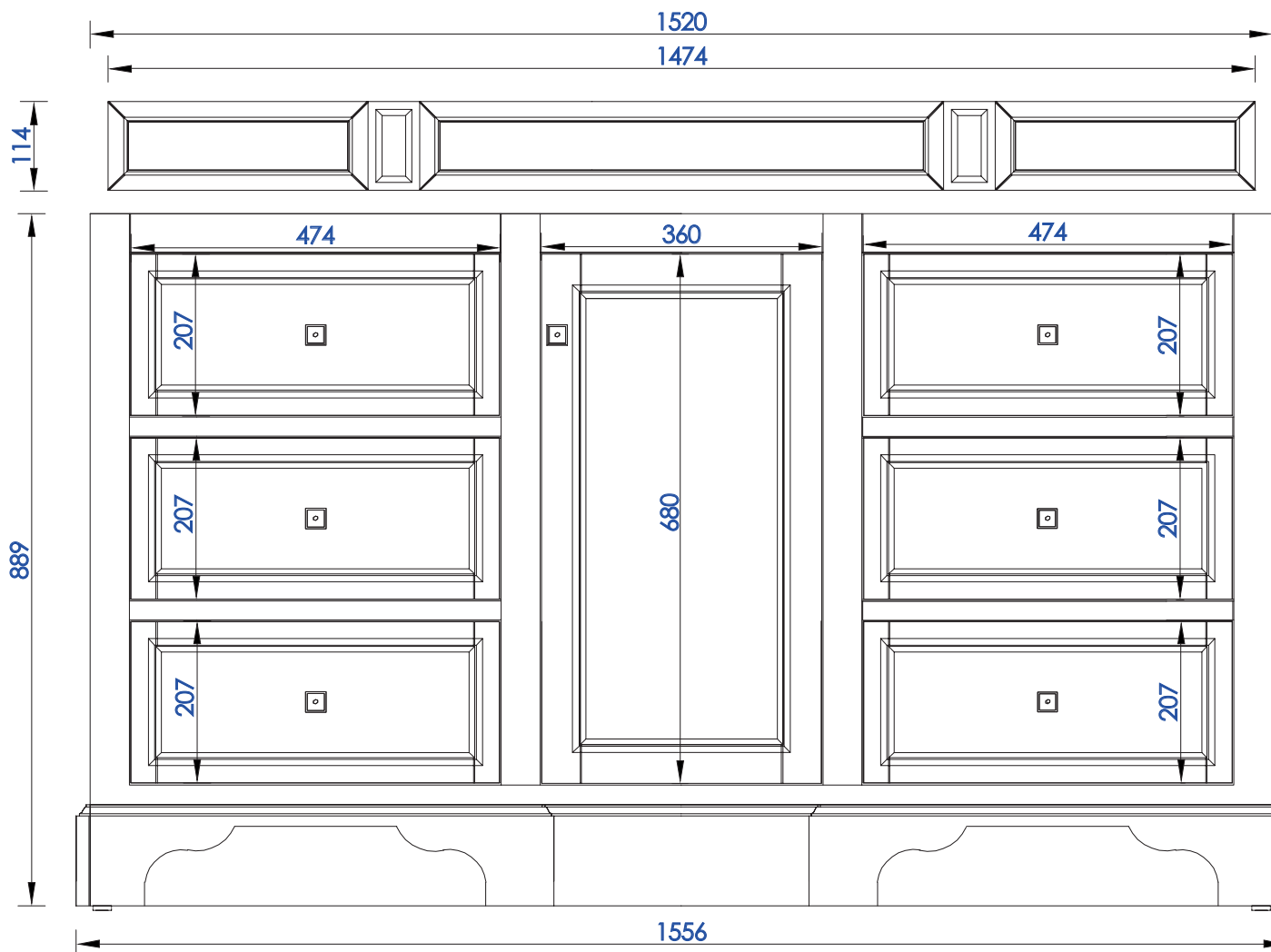

NOTE ONE: Countertops are not shown in these diagrams. (Cabinet Only)

NOTE TWO: Wood Backsplash (Shown) is designed for the molding detail to align with sinks in James Martin's Optional Countertops.

Customer's own countertops and sinks may align differently, and modification may be required.

Please consult our website for Countertop Diagrams: www.jamesmartinvanities.com

1524 mm

Item Number:

JAMES MARTIN

De Soto 1524mm Single Vanity

825-V60S-BNM
825-V60S-BW
825-V60S-SL

Diagrams with Dimensions
page 02 of 03



VANITIES

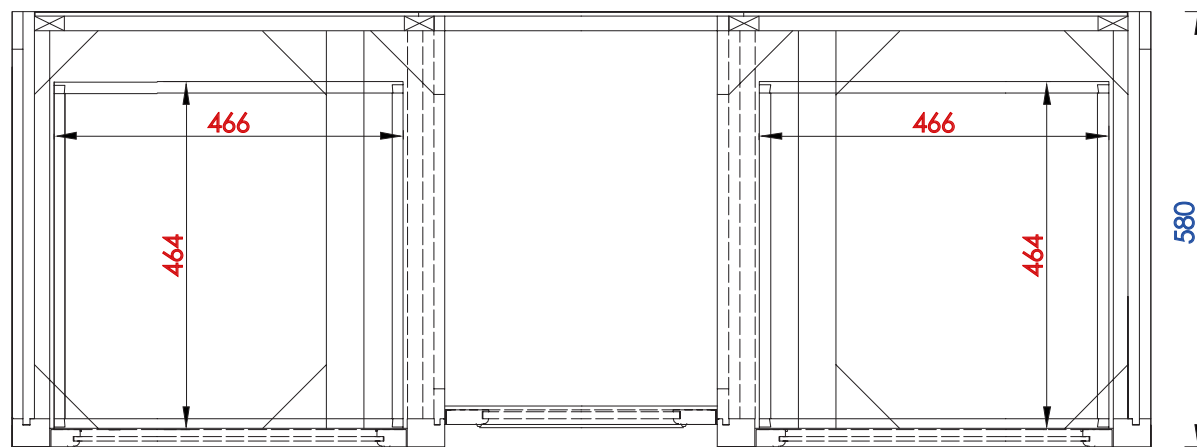
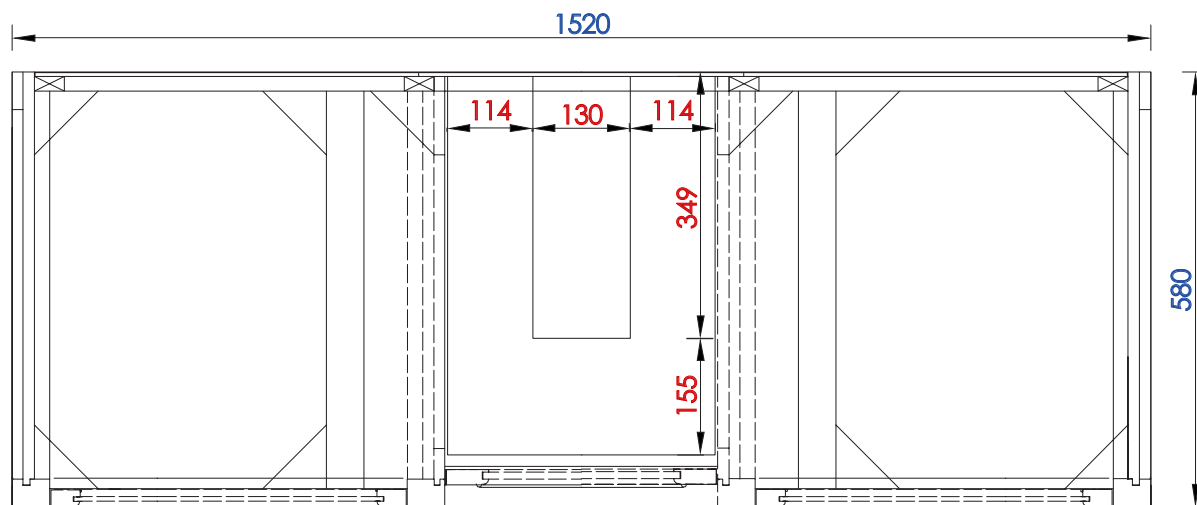

NOTE ONE: Countertops are not shown in these diagrams. (Cabinet Only)

NOTE TWO: Internal Shelves(Shown) are designed to align with sinks in James Martin's Optional Countertops.

Customer's own countertops and sink may align differently, and modification may be required.

Please consult our website for Countertop Diagrams: www.jamesmartinvanities.com

1524 mm

Item Number:

825-V60S-BNM
825-V60S-BW
825-V60S-SL

JAMES MARTIN



VANITIES

De Soto 1524mm Single Vanity

Diagrams with Dimensions
page 03 of 03

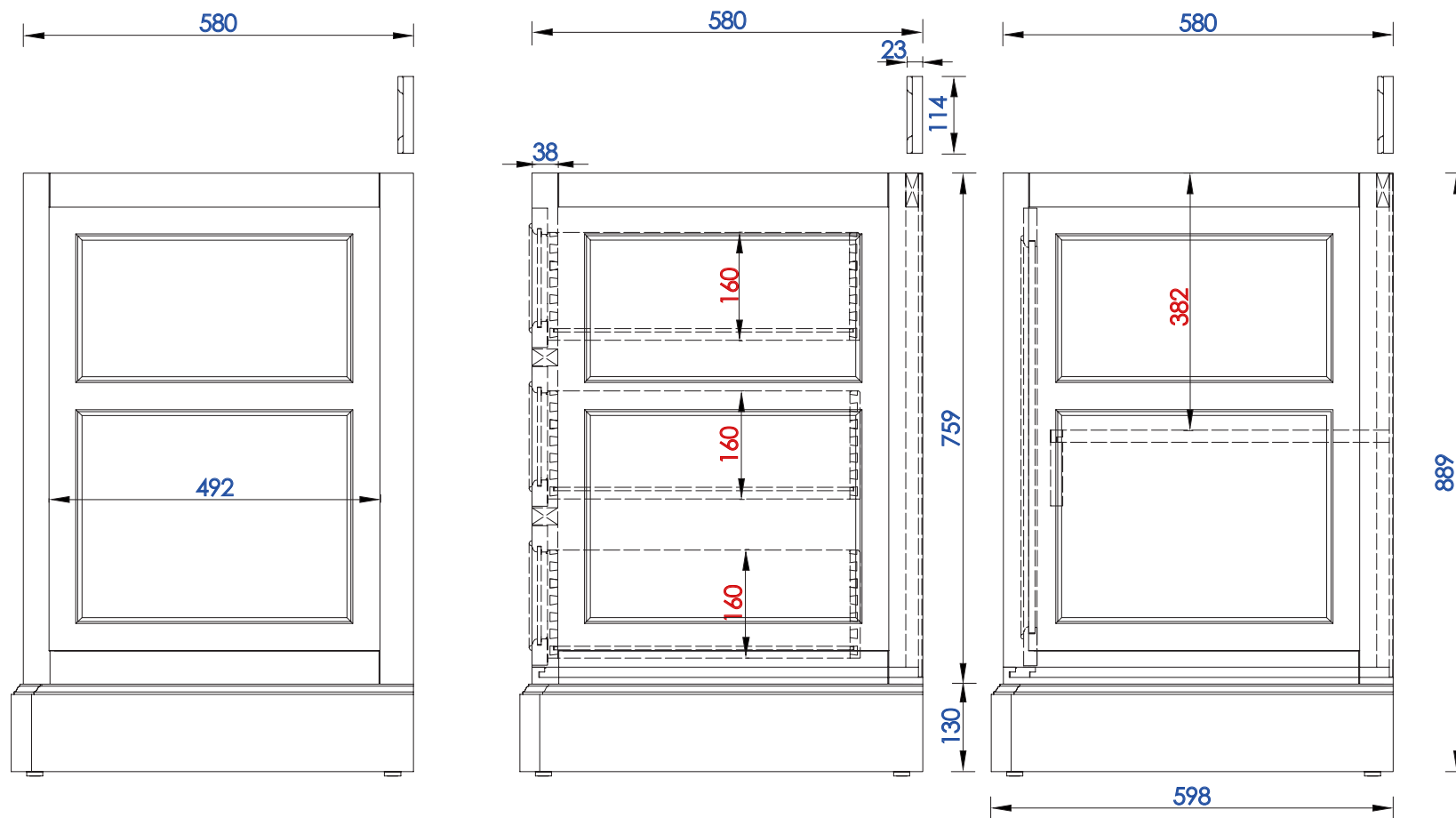

NOTE ONE: Countertops are not shown in these diagrams. (Cabinet Only)

NOTE TWO: Wood Backsplash (Shown) is designed for the molding detail to align with sinks in James Martin's Optional Countertops. Customer's own countertops and sinks may align differently, and modification may be required.

Please consult our website for Countertop Diagrams: www.jamesmartinvanities.com

60"S

Item Number:

825-V60S-BW/SL

JAMES MARTIN



VANITIES

De Soto 60"S Cabinet

Diagrams with Dimensions
page 01 of 01

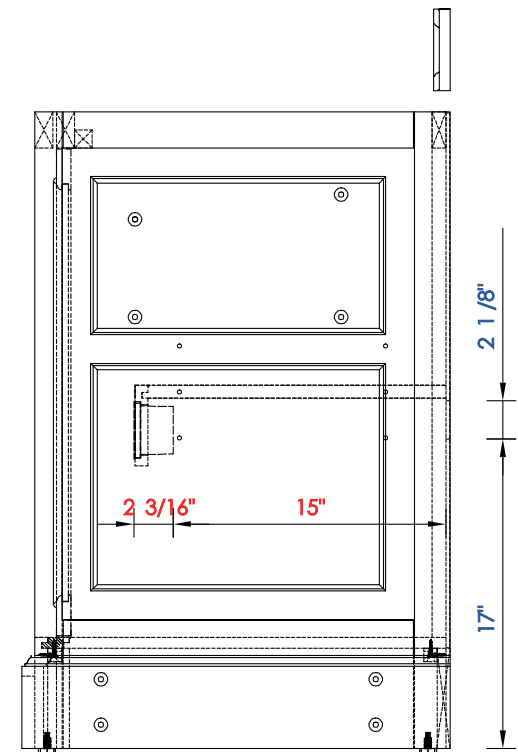
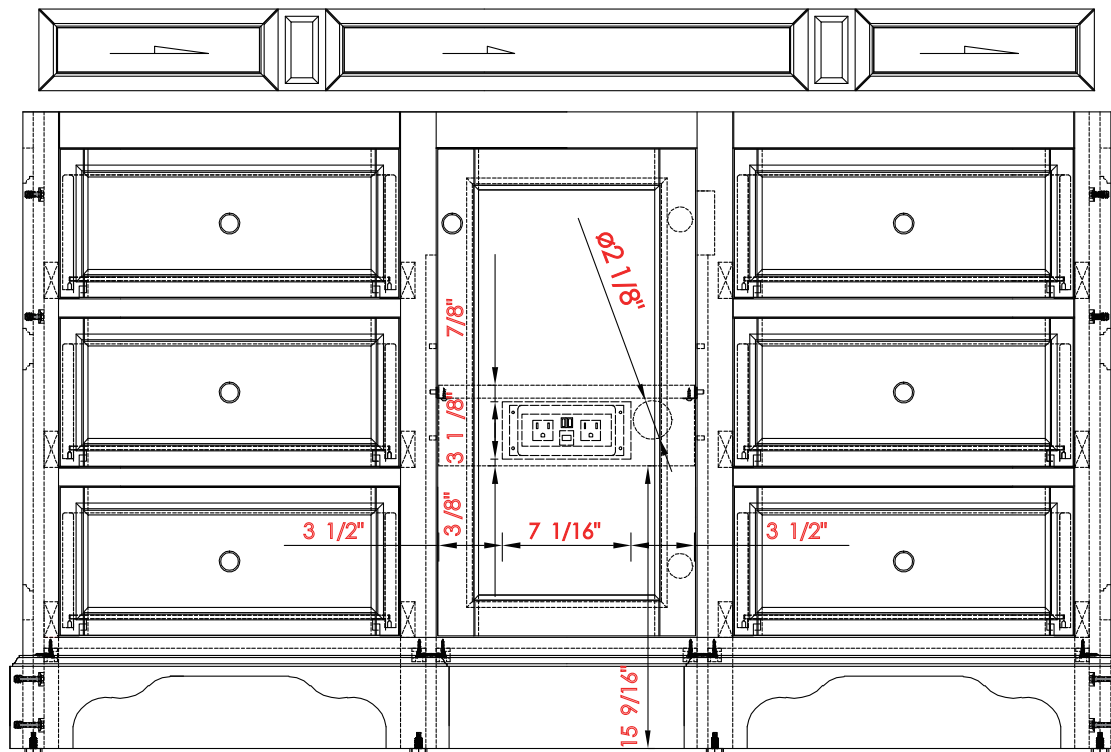

1524 mm

Item Number:

825-V60S-BWSL

JAMES MARTIN



VANITIES

De Soto 1524mm Cabinet

Diagrams with Dimensions
page 01 of 01

