

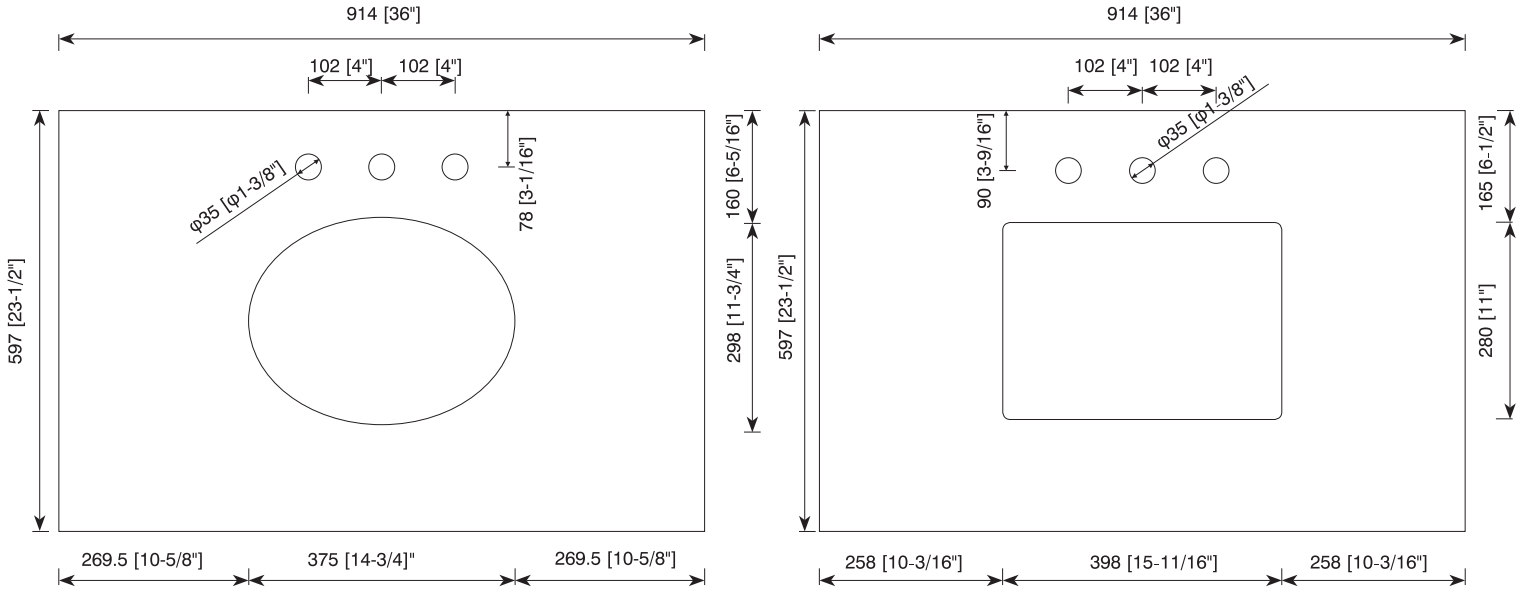

36" Vanity Top Assembly Instructions

James Martin Vanities Company always recommends you consult and/or hire a professional contractor when installing your vanity cabinet and top.



James Martin - Stone Top Measurement Specifications

Wood Risers

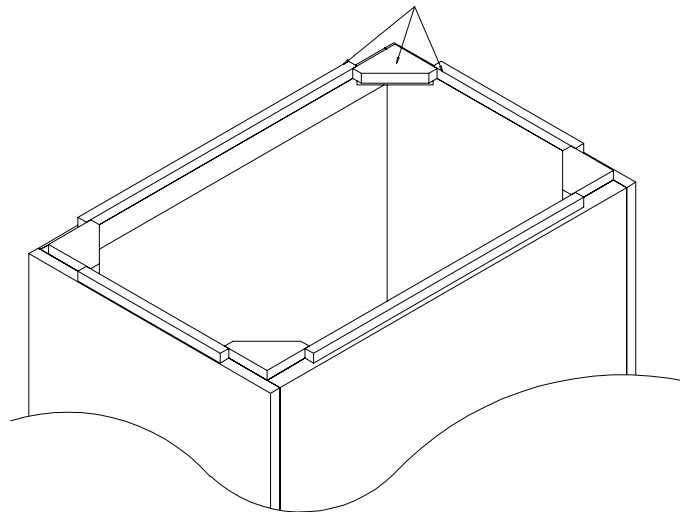

Wood risers are shipped, pre-attached, to this vanity cabinet.
These wood risers are used with James Martin's 4cm (1.5") Stone Tops.

The wood risers are not needed if you are attaching James Martin 2cm (.75")
or 3cm (1.18") Countertops.



36" Vanity Top Assembly Instructions

James Martin Furniture Company always recommends you consult and/or hire a professional contractor when installing your vanity cabinet and top.

Wood Backsplash (Optional) is shipped attached to the back side of the vanity cabinet.

4cm/1.5"
stone top

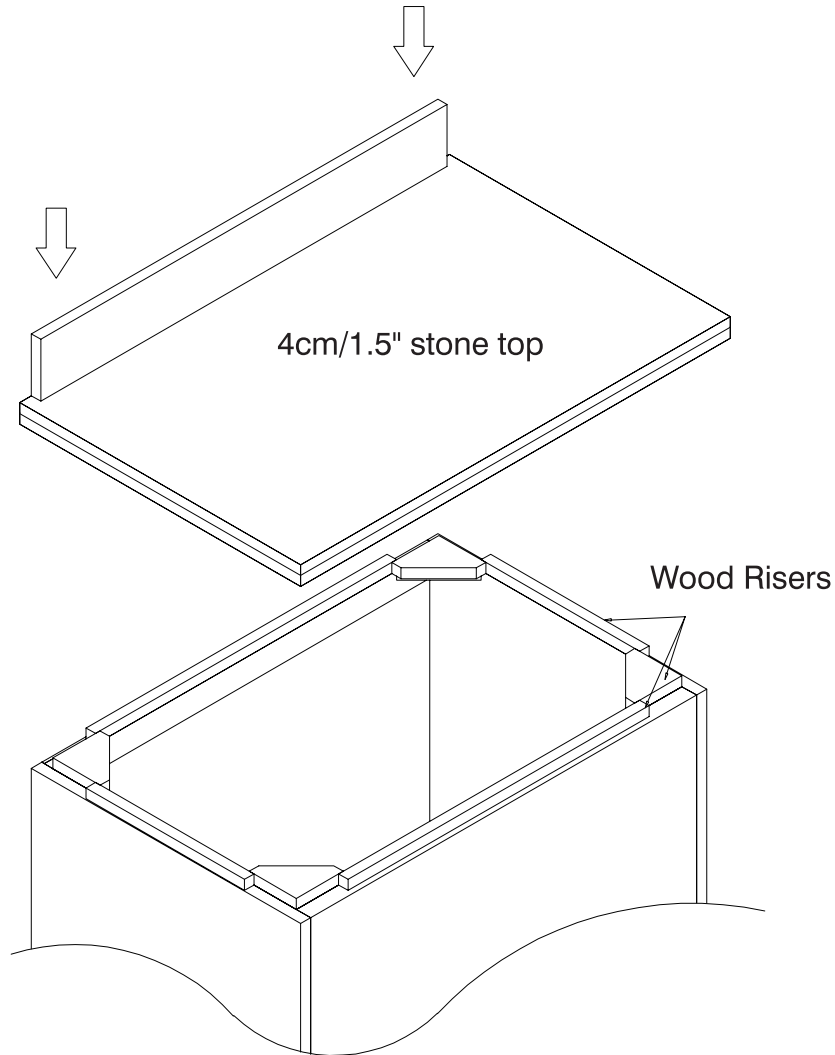

If you are attaching a 4cm (1.5") thickness, James Martin Stone Top; leave the wood risers attached.

These wood risers are required for the proper support of the 4cm Stone Top.

Please consult your professional contractor regarding the best Polyurethane Construction Adhesive to attach the Stone Top to the vanity cabinet and risers - and backsplash, if desired.

Please Note: The vanity cabinet's back panel is shipped un-cut, to allow for a variety of plumbing installation options.



36" Vanity Top Assembly Instructions

Wood Backsplash (Optional) is shipped attached to the back side of the vanity cabinet.

2cm/.75"
Countertop

Also use these
Instructions for
The tops below

3cm/1.18"
Countertop

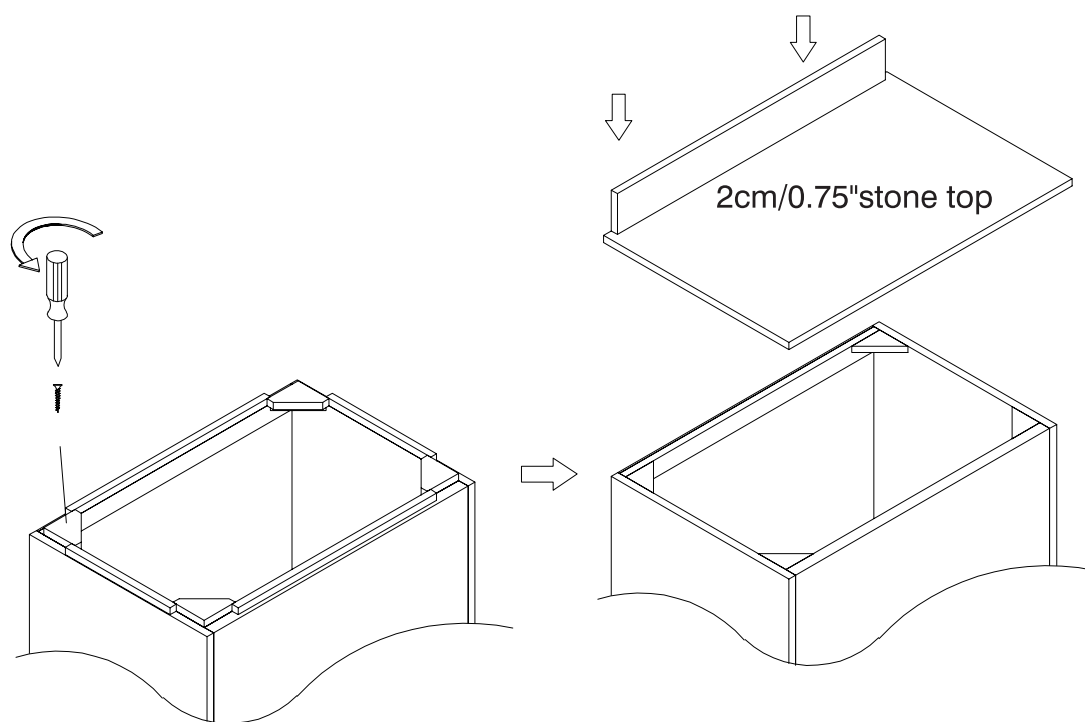

If you are attaching a 2cm (.75") or 3cm (1.18") thickness, James Martin Countertop; the wood risers need to be removed .

Use a "Phillips" (X-shaped) head screwdriver to remove the screws used to secure the wood risers.

Please consult your professional contractor regarding the best Polyurethane Construction Adhesive to attach the Countertop to the vanity cabinet - and backsplash, if desired.

Please Note: The vanity cabinet's back panel is shipped un-cut, to allow for a variety of plumbing installation options.