

PARTS LIST / LISTE DES PIÈCES / LISTA DE PIEZAS
 ITEM NO. / NO D'ARTICLE / ARTICULO NO. : P378180/181/172
 DESCRIPTION / LA DESCRIPTION / DESCRIPCIÓN: UPH KING BED / TRÈS GRAND LIT / CAMA TAMAÑO KING

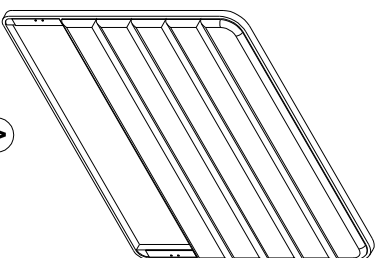

A
 x1 Headboard panel
 x1 Tête de lit
 x1 Panel de la cabecera

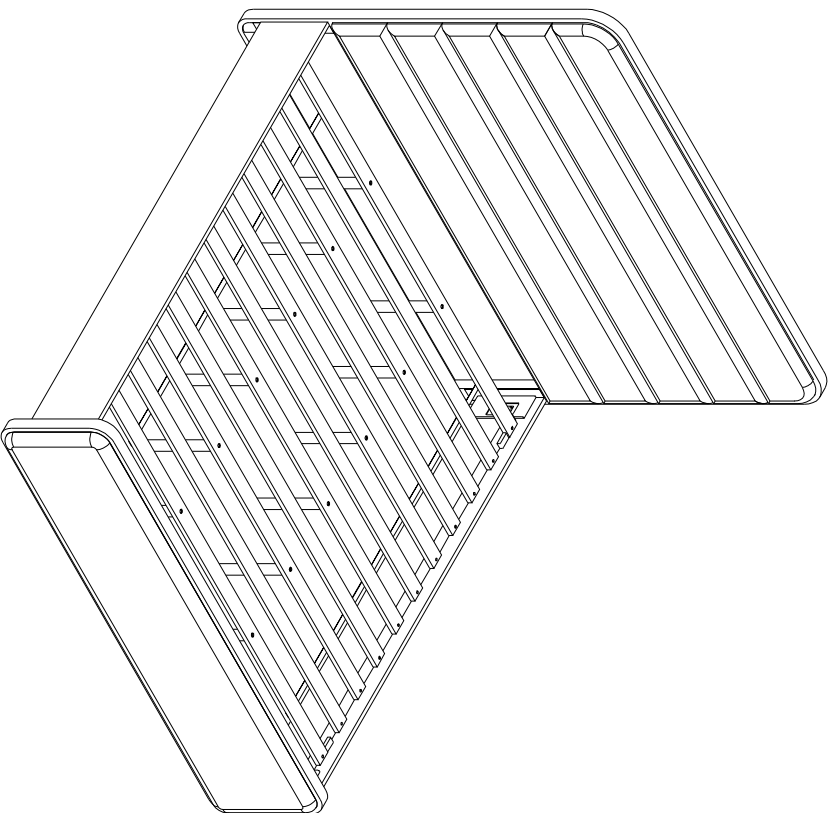
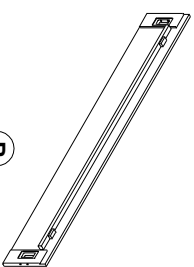

B
 x2 Side Rail
 x2 Traverse
 x2 Travesaño lateral

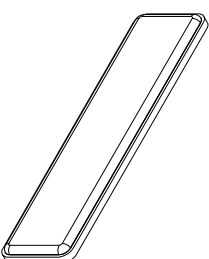

C
 x1 Footboard Panel
 x1 Pied de lit
 x1 Panel de pie de cama

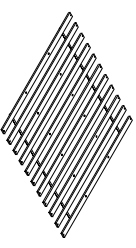

D
 x11 Slat *
 x11 Latte
 x11 Listón



E
 x12 Center leg *
 x12 Pattes centrales
 x12 Patas centrales



F
 x8 Hanger Bolt Ø5/16" x88mm *
 x8 Boulon-vis Ø5/16" x88mm
 x8 Perno de suspensión Ø5/16" x88mm



G
 x8 Flat Washer Ø5/16" x16x2mm *
 x8 Rondelle plate Ø5/16" x16x2mm
 x8 Arandela plana Ø5/16" x16x2mm



H
 x8 Lock washer Ø5/16" *
 x8 Rondelle de blocage Ø5/16"
 x8 Arandela de Seguridad Ø5/16"



I
 x8 Hex nut Ø5/16" *
 x8 Ecriou hexagonal Ø5/16"
 x8 Tuerca hexagona Ø5/16"



J
 x1 Open Wrench Ø5/16" *
 x1 Clé à fourche Ø5/16"
 x1 Llave de boca Ø5/16"



K
 x22 Wood Screw #8x25mm *
 x22 Vis à bois #8x25mm
 x22 Tornillo para madera #8x25mm

* Replaceable Part

ASSEMBLY INSTRUCTIONS/ NOTICE DE MONTAGE/ INSTRUCCIONES DE MONTAJE
 ITEM NO./ NO DARTICLE/ ARTICULO NO. : P378180/181/172
 DESCRIPTION/ LA DESCRIPTION/ DESCRIPCIÓN: UPH KING BED/ TRÈS GRAND LIT/CAMA TAMAÑO KING

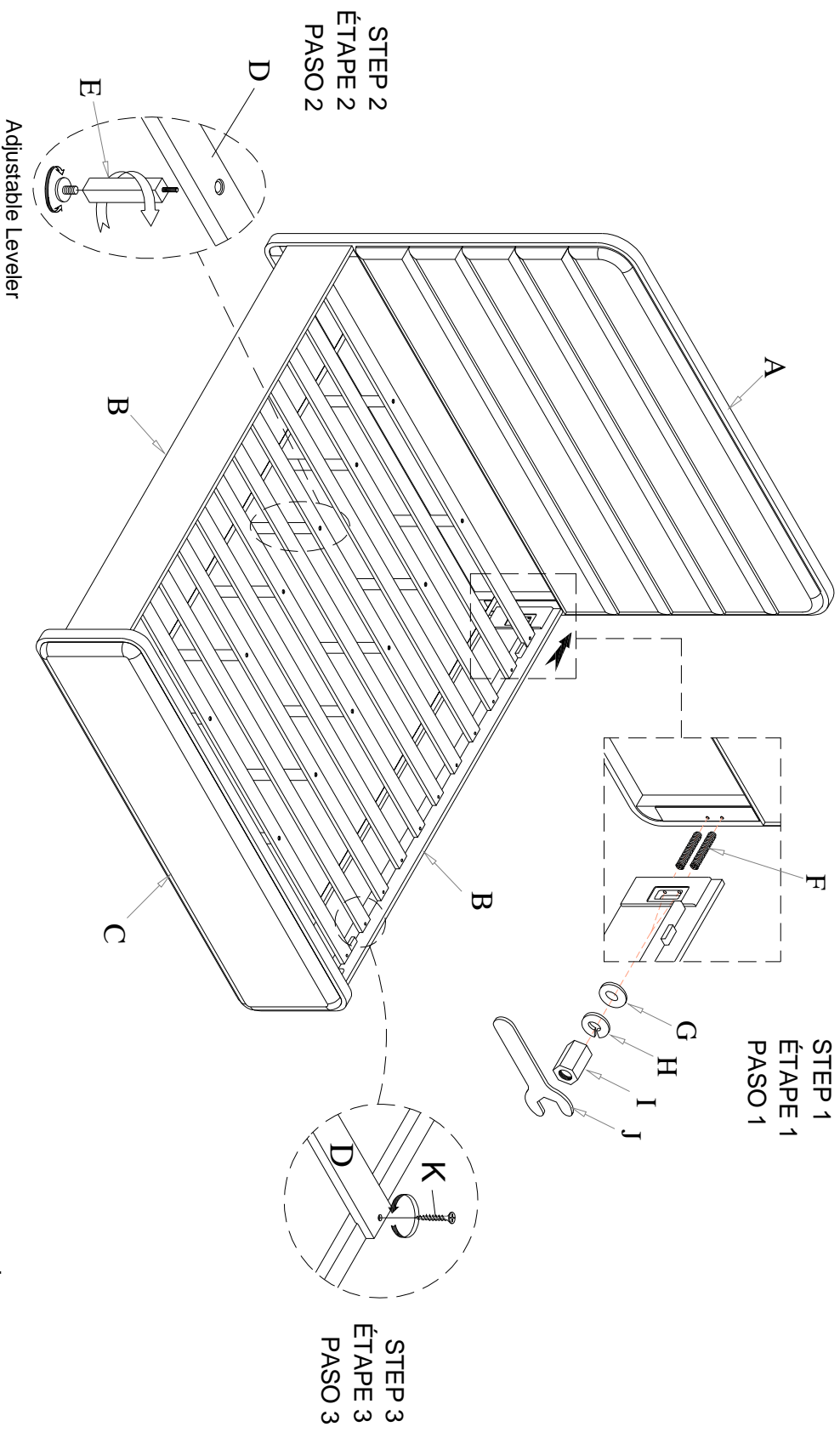

* Replaceable Part

REPLACEABLE PART / PARTIE REMPLAÇABLE / PARTE REEMPLAZABLE
 ITEM NO. / NO D'ARTICLE / ARTICULO NO. : P3781180/181/172
 DESCRIPTION / LA DESCRIPTION / DESCRIPCIÓN: UPH KING BED / TRÈS GRAND LIT/CAMA TAMAÑO KING

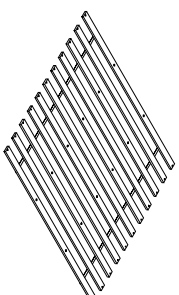
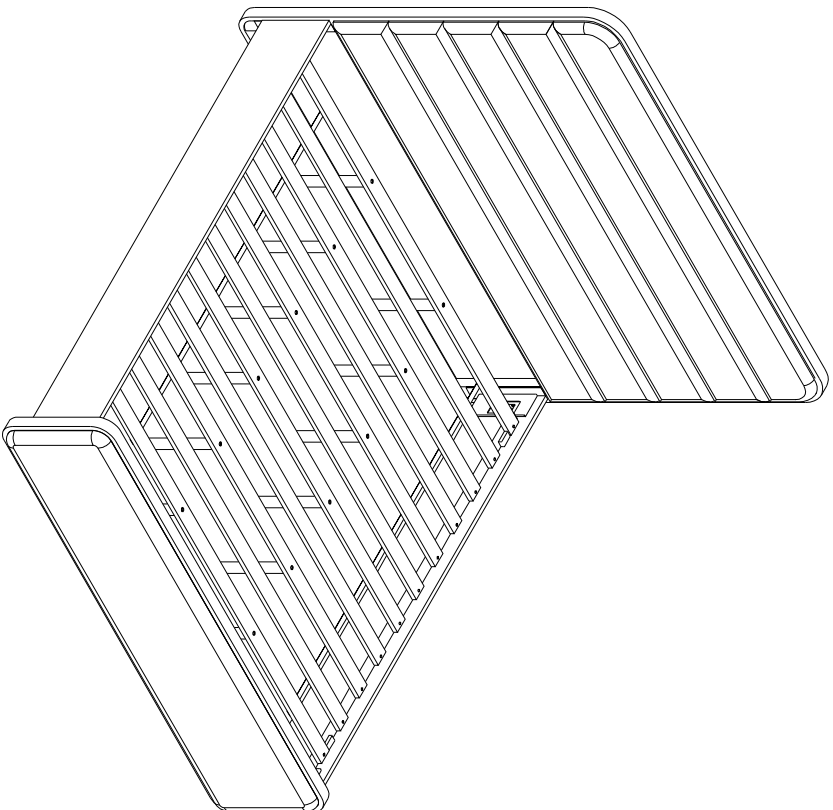

x11 RP378181-SLAT-Slat *
 Lattes
 Listones



x12 RP378181-SULEG-Slat Support Leg *
 Pattes centrales
 Patas centrales



x22 RP378181-SCREW-SCREW-Screw *
 Vis à bois
 Tornillo para madera

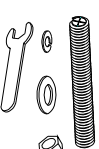

x1 RP378172-HWKIT-Hardware *
 Liste des pièces de quincaillerie
 Lista del kit de materiales



x 12 RC-FG-WHITE-White Leveler *
 Patin réglable
 Nivelador

* Replaceable Part

Protect Your Wood or Laminate Flooring

* This statement applies to any floor without carpet.

If not careful, all furniture including upholstery and case pieces can scratch, scuff and even gouge floors. The recommendation is to have felt, rubber pads or area rugs under furniture on flooring without carpet.

Moving your furniture

Pushing and dragging furniture over floor without carpet can lead to scratches and scuffs. Have someone help when moving the larger pieces of furniture by lifting, try using a dolly or moving pads.

Felt and rubber pads

Applying furniture pads to the feet of furniture helps cushion contact points. Furniture pads can be found at local hardware stores. Felt pads slide easily across the floor, making them ideal for dining chairs and other pieces that move with use. Rubber pads will help furniture stay in place and are perfect for larger pieces, like sofas and loveseats.

Area rugs and rug pads

Using an are rug under furniture is another way to protect your floor from scratches and scuff marks. A rug pad under the area rug will provide extra cushion and added protection.

* *Reproachable Part*