

<b>⚠ WARNING</b>	
	<p>Children have died from furniture tipover. To reduce the risk of furniture tipover:</p> <ul style="list-style-type: none"> <li>• <b>NEVER</b> put a TV on this product.</li> <li>• <b>NEVER</b> allow children to stand, climb or hang on drawers, doors, or shelves.</li> <li>• <b>NEVER</b> open more than one drawer at a time.</li> <li>• Place heaviest items in the lowest drawers.</li> </ul> <p>This is a permanent label. Do not remove!</p>
	

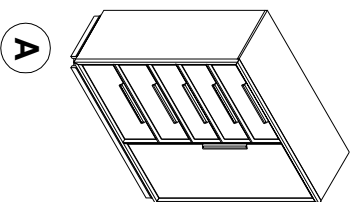

- x1 Chest
- x1 Commode
- x1 Comoda

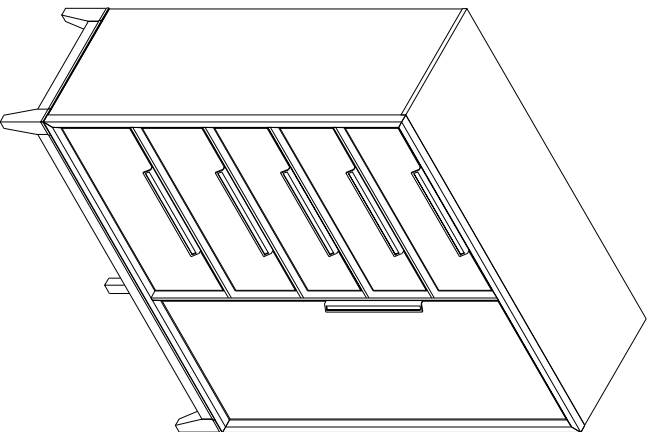

- x2 Front leg \*
- x2 Patte avant
- x2 Pata delantera

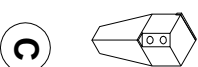

- x1 Back leg (left) \*
- x1 Patte arrière (gauche)
- x1 Pata trasera (izquierda)



- x1 Back leg (right) \*
- x1 Patte arrière (droite)
- x1 Pata trasera (derecha)



- x8 Flat Washer  $\phi 5/16" \times 1.9 \times 2mm$  \*
- x8 Rondelle plate  $\phi 5/16" \times 1.9 \times 2mm$
- x8 Arandela plana  $\phi 5/16" \times 1.9 \times 2mm$



- x8 Lock washer  $\phi 5/16"$  \*
- x8 Rondelle de blocage  $\phi 5/16"$
- x8 Arandela de Seguridad  $\phi 5/16"$

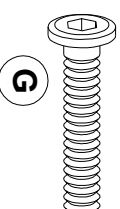

- x8 Allen bolt  $\phi 5/16" \times 51mm$  \*
- x8 Vis à tête creuse hexagonale  $\phi 5/16" \times 51mm$
- x8 Perno Allen  $\phi 5/16" \times 51mm$

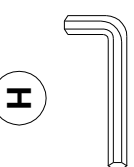

- x1 Allen Key 5mm \*
- x1 Clé hexagonale 5mm
- x1 Llave Allen 5mm



- x1 Furniture Tipping Restraint \*
- x1 Systeme antbasculement
- x1 Control para evitar vuelcos

\* **Replaceable Part**

## ⚠ WARNING



Children have died from furniture tipover. To reduce the risk of furniture tipover:

- **NEVER** put a TV on this product.
- **NEVER** allow children to stand, climb or hang on drawers, doors, or shelves.
- **NEVER** open more than one drawer at a time.
- Place heaviest items in the lowest drawers.

This is a permanent label. Do not remove!

## STEP 2 ÉTAPE 2 PASO 2

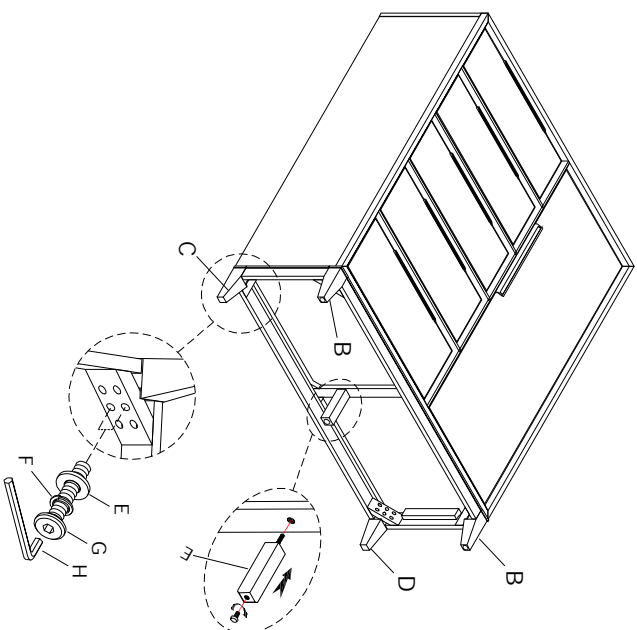

Bun Foot Carton  
Boîte des pieds en forme  
Caja de las patas redondas

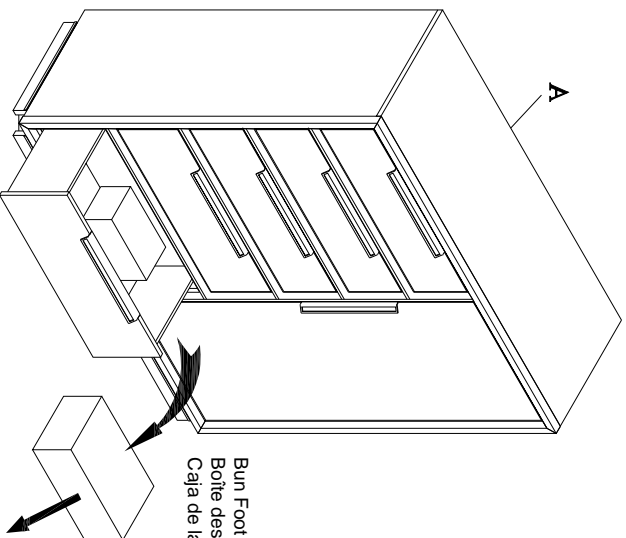

## STEP 1 ÉTAPE 1 PASO 1

## STEP 3 ÉTAPE 3 PASO 3

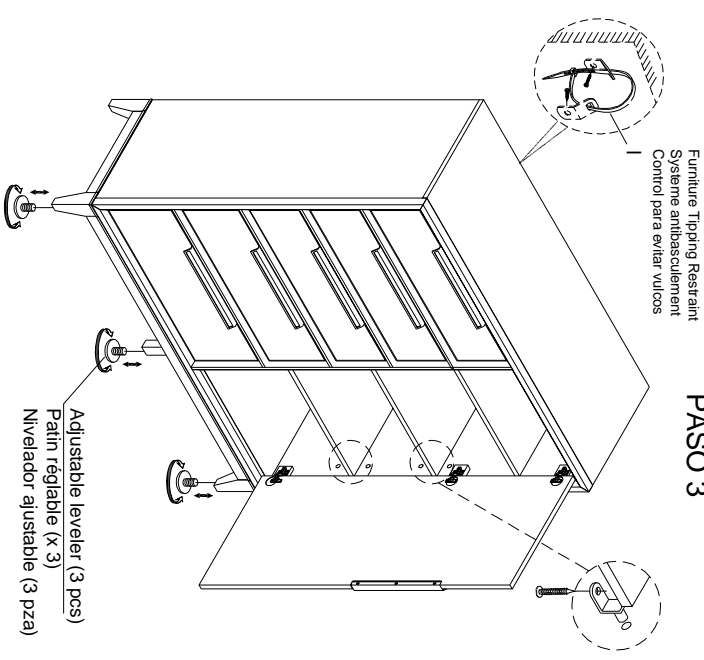

\* **Replaceable Part**

Adjustable leveler (3 pcs)  
Patins réglable (X 3)  
Nivelador ajustable (3 pza)









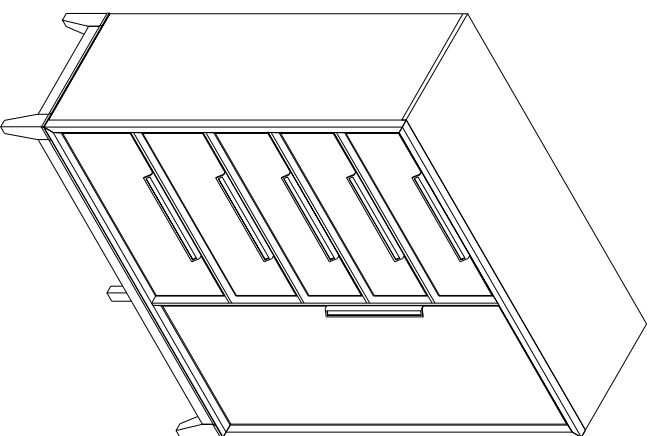

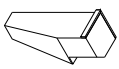
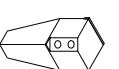
## REPLACEABLE PART / PARTIE REMPLAÇABLE / PARTE REEMPLAZABLE

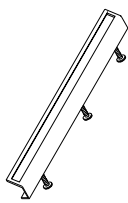
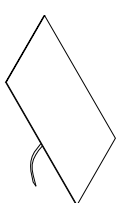
ITEM NO. / NO D'ARTICLE / ARTICULO NO. : P375125

DESCRIPTION / LA DESCRIPTION / DESCRIPCIÓN: DOOR CHEST / COMMUNE AVEC PORTE / CÔMUNA CON PUERTAS

<b>⚠ WARNING</b>	
	<p>Children have died from furniture tipover. To reduce the risk of furniture tipover:</p> <ul style="list-style-type: none"> <li>• <b>NEVER</b> put a TV on this product.</li> <li>• <b>NEVER</b> allow children to stand, climb or hang on drawers, doors, or shelves.</li> <li>• <b>NEVER</b> open more than one drawer at a time.</li> <li>• Place heaviest items in the lowest drawers.</li> </ul> <p>This is a permanent label. Do not remove!</p>
	

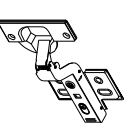

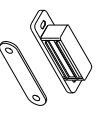
- |   |   |   |   |
|---|---|---|---|
| <p>x2 RP375125-FLEG-FRONT LEG *<br/>Jambes<br/>Piernas</p>    | <p>x1 RP375125-BLEGL-BACK LEG-Left *<br/>Jambes<br/>Piernas</p>                          | <p>x1 RP375125-BLEGR-BACK LEG-Right *<br/>Jambes<br/>Piernas</p>   | <p>x1 RP375125-CE-Center Leg *<br/>Support central<br/>Soporte para la pata central</p>  |
| <p>x6 RP375125-PULLL - Long Pull with Screw *<br/>Poignée + vis<br/>Tirador + Tornillo</p>                          | <p>x1 RP375125-FELT-Removable Felt *<br/>Removable Felt<br/>Futre Feltro</p>               | <p>x5 COMGLIDE-10-45 - Drawer Glide *<br/>Tiror Glide<br/>Deslizamiento del cajón</p>                        | <p>x3 RC-FG-WHITE-White Leveler *<br/>Patín réglable<br/>Nivelador</p>                     |
| <p>x1 RP375125-HWKIT-Hardware kit list *<br/>Liste des pièces de quincaillerie<br/>Lista del kit de materiales</p>  | <p>x2 RC-WH-NAIL - White Plastic Nail *<br/>Clou en plastique<br/>Clavo de plástico</p>    | <p>x1 RC-ANTI-TIP- Anti-tipping Restraint *<br/>Système antibasculement<br/>Control para evitar vuelcos</p>  | <p>x3 RP375125-HINGE-Door Hinge *<br/>Charnière de porte<br/>Bisagra de la puerta</p>      |
| <p>x3 RP375125-SHELF-Wood Shelf *<br/>Étagère<br/>Repsal/ Estante</p>   | <p>x12 RP375125-PIN-Shell Pin *<br/>Supports Pour<br/>Tablette Sopoite De Las Repisas</p>  | <p>x1 RP375125-CATCH-Door Catch *<br/>Catch de aimant<br/>Captura de imán</p>                                |   |

\* Replaceable Part

Residential Use Only

Made In Vietnam / Fabriqué au Vietnam / Hecho en Vietnam  
For assembly instruction video, please go to: [www.myfurnitureinstructions.com](http://www.myfurnitureinstructions.com)

## **Protect Your Wood or Laminate Flooring**

\* This statement applies to any floor without carpet.

If not careful, all furniture including upholstery and case pieces can scratch, scuff and even gouge floors. The recommendation is to have felt, rubber pads or area rugs under furniture on flooring without carpet.

### **Moving your furniture**

Pushing and dragging furniture over floor without carpet can lead to scratches and scuffs. Have someone help when moving the larger pieces of furniture by lifting, try using a dolly or moving pads.

### **Felt and rubber pads**

Applying furniture pads to the feet of furniture helps cushion contact points. Furniture pads can be found at local hardware stores. Felt pads slide easily across the floor, making them ideal for dining chairs and other pieces that move with use. Rubber pads will help furniture stay in place and are perfect for larger pieces, like sofas and loveseats.

### **Area rugs and rug pads**

Using an are rug under furniture is another way to protect your floor from scratches and scuff marks. A rug pad under the area rug will provide extra cushion and added protection.

\* *Replaceable Part*