

ASSEMBLY AND INSTALLATION INSTRUCTIONS

WARNING: Turn off the main power at circuit breaker before installing fixture.
AVERTISSEMENT: Coupez la source d'alimentation principale au panneau central de disjoncteurs avant d'installer le luminaire.

NOTE: 1. Before installing, consult local electrical codes for wiring and grounding requirements.
2. READ AND SAVE THESE INSTRUCTIONS.

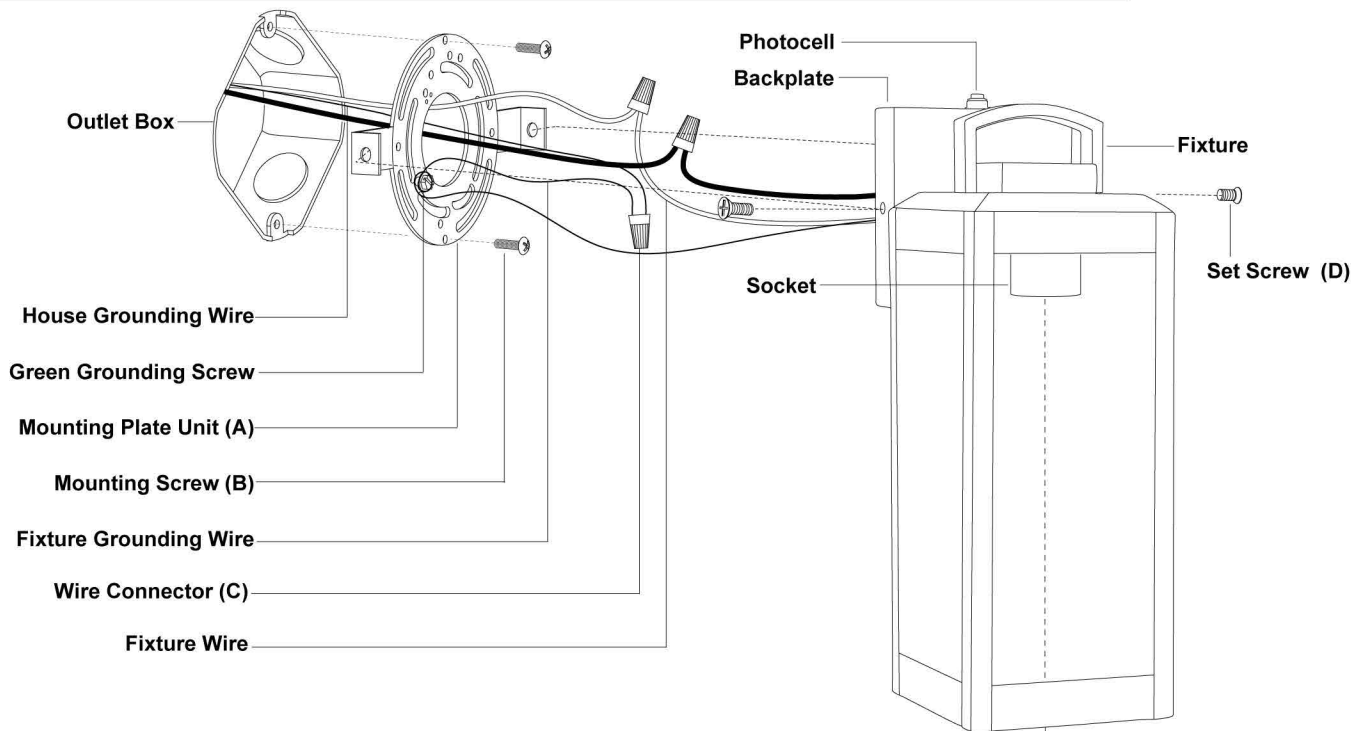
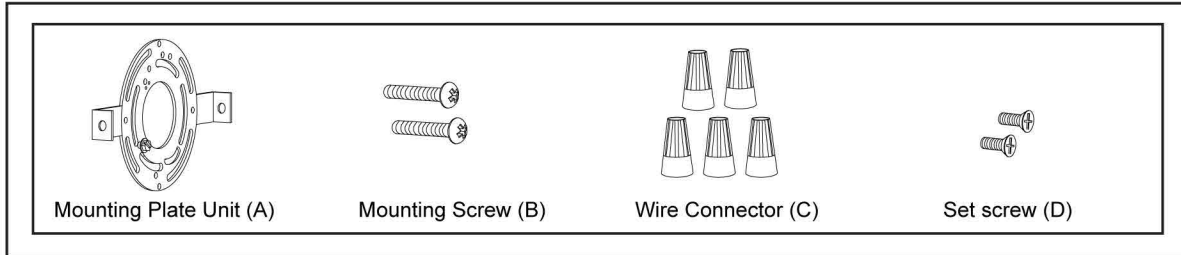

Installation Steps

Turn off the power at fuse or circuit box

1. Remove the two set screws (D), the mounting plate unit (A) from the backplate.
2. Attach the mounting plate unit (A) to the outlet box by using two mounting screws (B).

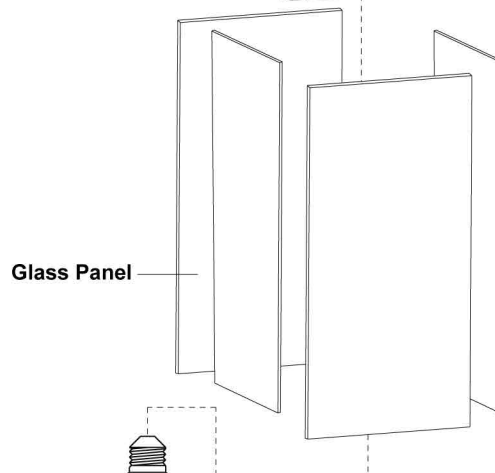

Max.60W Type T10 Bulb
(not included)



3. Pull out the source wires from the outlet box. Make wire connections using wire connectors (C) as follows:
 - Connect the hot wire (usually black insulation) from the fixture to the black wire from the power source.
 - Connect the neutral wire (usually white insulation) from the fixture to the white wire from the power source.
 - Attach the fixture grounding wire (usually green insulation or bare wire) to the mounting plate unit (A) with the green grounding screw, then connect it to the house grounding wire with the wire connector (C).
 Carefully put all of the wires back into the outlet box.

4. Attach the backplate to the mounting plate unit (A) by aligning holes, secure the two set screws (D) from the side hole of the backplate into the hole in the side of the mounting plate unit (A).

Note: With silicone caulking compound, caulk completely around where the backplate meets with the wall surface to prevent water from seeping into the outlet box.

5. Gently insert the glass panels into the bottom clips of fixture, then press the top clips to secure the glass panels. (See Fig.1 and Fig.2)

6. Install bulb (not included). Check relamping label at socket area or packaging for maximum wattage allowed.

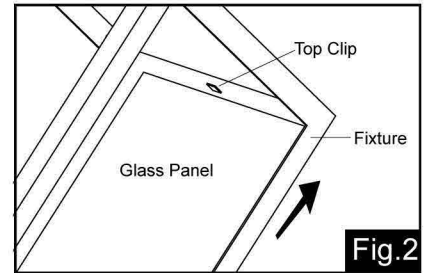
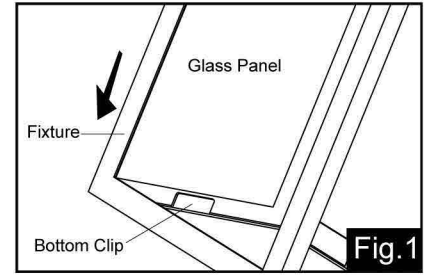

Turn on the power at fuse or circuit box

Optional Installation: Disconnect Dusk-to-Dawn Photocell

IMPORTANT:

Compatible with dimmer when photocell is disconnected.

* Requires dimmable bulb and compatible dimmer switch.

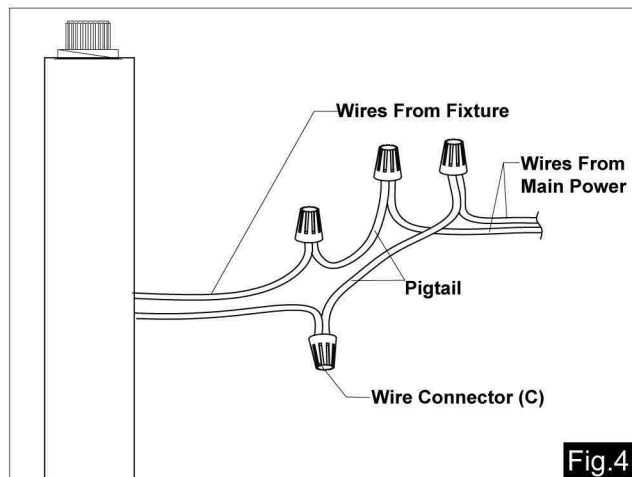
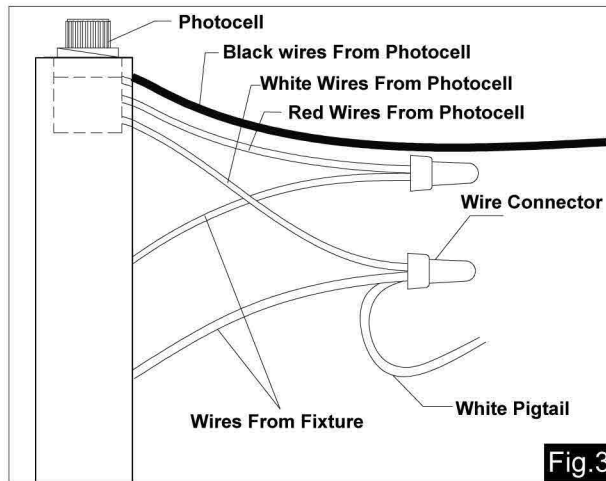

1. Turn off the power at the fuse or circuit box before starting installation.
2. Loosen the wire connector connected with the wires from photocell. (See Fig.3)

Note: Do not remove the photocell to prevent water from seeping into the outlet box.
3. Take a white pigtail and black pigtail and make wire connections using wire connector (C): (See Fig.4)
 - a. The black wire from the fixture to one end of the black pigtail.
 - b. The white wire from the fixture to one end of the white pigtail.
 - c. The other end of the black pigtail to the black wire from the power source.
 - d. The other end of the white pigtail to the white wire from the power source.
 Put all wires back into the backplate of the fixture.

Turn on the power at fuse or circuit box.

The following parts are available for re-order if damaged or missing.

Spare Parts List:

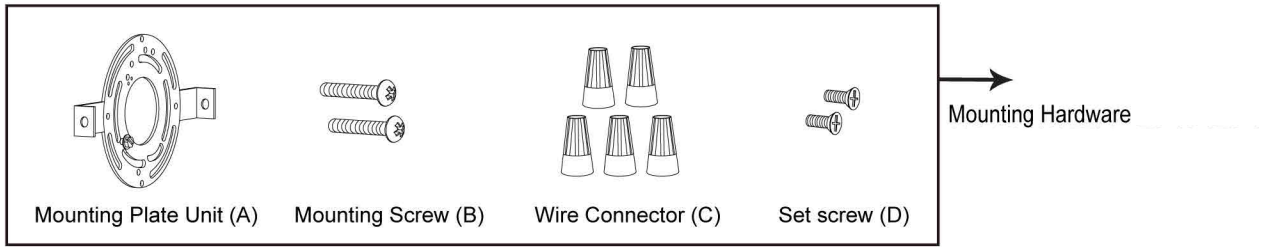

Glass Panel

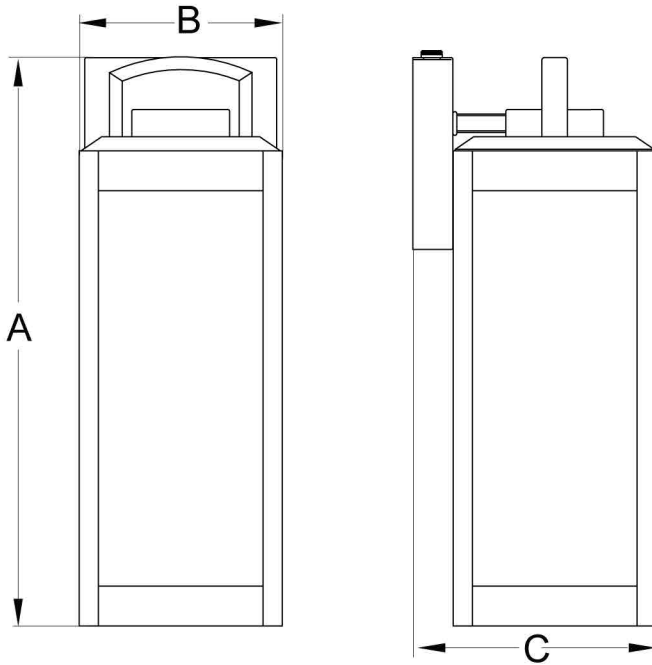

A: 14-1/4"
B: 5"
C: 6"