

**Jacuzzi® Concealed Roller Bathtub & Shower Doors**

Letter	Description	60" x 59" Bathtub Door	48" x 76" Shower Door	60" x 76" Shower Door	Key Features
-	Opening Method	Single Bypass Sliding	Single Bypass Sliding	Single Bypass Sliding	Semi-Frameless Construction Durable Safety Tempered Glass Coated for Easy Cleaning Slow-Closing Technology for Smooth, Quiet Operation Generous Out-of-Plumb Adjustability Simplifies Installation in Existing Alcoves Anodized Aluminum Material Delivers Lasting Quality
-	Glass Thickness	5/16" (8 mm)			
-	Installation Type	Alcove			
-	Installation Position Options	Left or Right Hand (see manual for instructions)			
-	Product Weight	120 lbs (54.4 kg)	123 lbs (55.8 kg)	150 lbs (68.0 kg)	
A	Product Height	59" (1,499 mm)	76" (1,930 mm)	76" (1,930 mm)	
B1	Maximum Wall Opening	59.84" (1,520 mm)	47.83" (1,215 mm)	59.84" (1,520 mm)	
B2	Minimum Wall Opening	57.84" (1,469 mm)	45.83" (1,164 mm)	57.84" (1,469 mm)	
-	Out-of-Plumb Adjustability	1" (25mm) on each side - 2" Total			
-	Out-of-Plumb Adjustment Point(s)	Rollers & Wall Jambs			
C/D	Fixed Panel Dim. (LxH)	26.8" x 57.4" (681 mm x 1,458 mm)	20.8" x 74.4" (528 mm x 1,890 mm)	26.8" x 74.4" (681 mm x 1,890 mm)	<b>Available Finishes</b> Polished Chrome Brushed Nickel Matte Black
E/F	Sliding Panel Dim. (LxH)	30.0" x 58.6" (762 mm x 1,488 mm)	24.0" x 75.6" (610 mm x 1,920 mm)	30.0" x 75.6" (762 mm x 1,920 mm)	
G	Door Opening Length	25.2" (640 mm)	19.2" (488 mm)	25.2" (640 mm)	
H	Door Opening Height	57" (1,448 mm)	74" (1,880 mm)	74" (1,880 mm)	
I	Overall Width	2.5" (64 mm)			
-	Threshold Width Required	2.25" (57mm)			

Note: Nominal door sizes correspond to matching pan dimensions, as shower wall material decreases alcove length.

**KEY DIMENSIONS**

Note: Drawings not to scale.

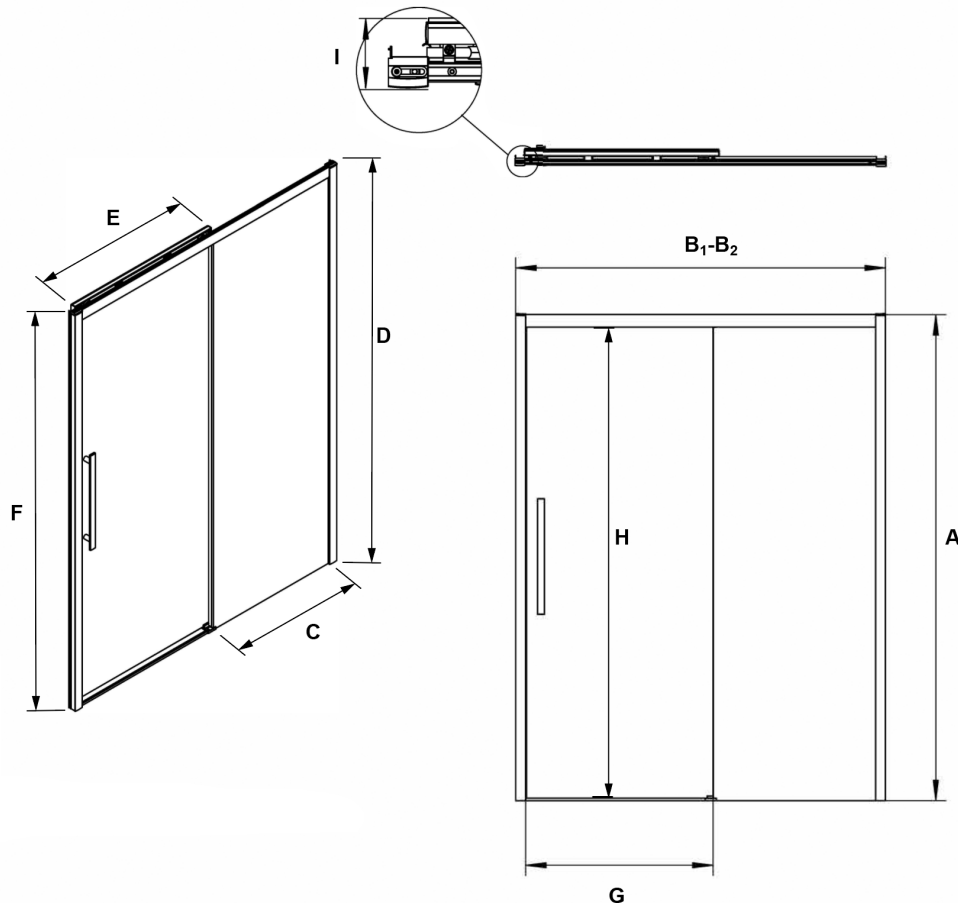

©2019 Jacuzzi Inc. • For additional information, call Customer Service 800-288-4002 • [www.jacuzzi.com/baths](http://www.jacuzzi.com/baths)  
 Refer to installation instructions included with fixture before beginning installation. Please confirm product availability and specifications before commencing with any installation work.

PRODUCT SPECIFICATIONS AND AVAILABILITY ARE SUBJECT TO CHANGE WITHOUT NOTICE