

48" Deluxe Grab Bar with Contemporary Hex Flange

Model #: 2948-



FEATURES:

- ADA compliant when properly installed
- Complements Astor & Westfield collections
- Covers standard 3" flange on existing stainless steel grab bars
- No need to re-tile in retro-fit applications
- 1 1/4" diameter
- For large quantity custom lengths contact hospitality@jaclo.com
- Not available in PG, & SG, for grab bars 36" or longer, but for large quantity orders inquire with hospitality@jaclo.com
- 36" center post to center post

AVAILABLE FINISHES:

Polished Chrome (PCH)	Satin Chrome (SC)	Bronze Umber (BU)
Satin Nickel (SN)	Pewter (PEW)	Caramel Bronze (CB)
Polished Nickel (PN)	Antique Brass (AB)	Antique Copper (ACU)
Oil-Rubbed Bronze (ORB)	Polished Brass (PB)	Polished Copper (PCU)
Vintage Bronze (VB)	Satin Brass (SB)	Matte Black (MBK)
Black Nickel (BKN)	White (WH)	Unlacquered Brass (ULB)
Satin Cooper (SCU)	Almond (ALD)	Amber (AMB)
Azure Blue (AZB)	Coral (COR)	Mint Green (GRN)
Stone Grey (GRY)	Lilac (LAC)	Light Blue (LBL)
Limon (LIM)	Plum (PLM)	Pink (PNK)
Red (RED)	Graphite (GPH)	
Aged Unlacquered Brass (AUB)		

SPECIFICATION DRAWING:

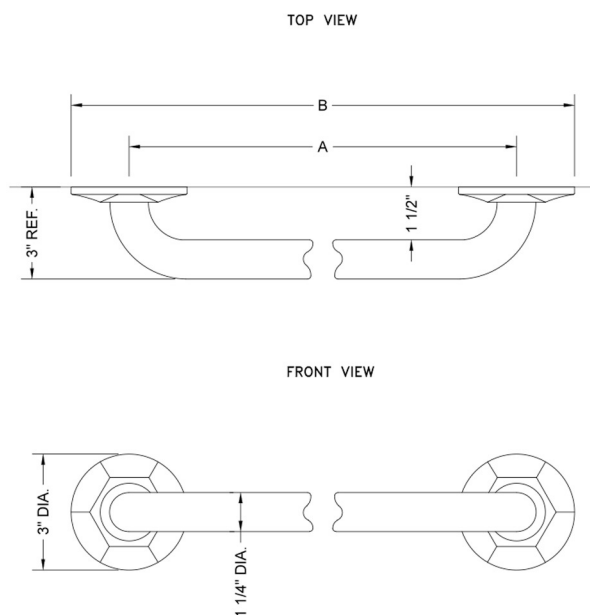

GRAB BAR WITH CONTEMPORARY HEX FLANGE			
PART. #	DESCRIPTION	A	B
2912	12" GRAB BAR	12"	15"
2916	16" GRAB BAR	16"	19"
2918	18" GRAB BAR	18"	21"
2924	24" GRAB BAR	24"	27"
2932	32" GRAB BAR	32"	35"
2936	36" GRAB BAR	36"	39"
2942	42" GRAB BAR	42"	45"
2948	48" GRAB BAR	48"	51"